



OWNER'S MANUAL

WASHING MACHINE

Please read this manual carefully before operating your washing machine and retain it for future reference.

WTG9532VH
WTG9532WH
WTG8532WH



MFL69022796

www.lg.com

Product Features



The Turbo Drum DD washing machine does not operate with the lid open. If the lid is opened during wash, rinse and spin cycles, the machine will stop automatically.



Please close the door gently. Closing the door in an aggressive manner can cause damage and/or injury.

Smart Drum achieved by DD Motor Technology

- The incorporated Smart Drum allows a more cleaner and hygienic wash tub that also protects against fabric wear due to washing.



Automatic heating system

- Using its in built heater, the water for the Allergy and Stain Care cycle is heated to a predetermined temperature, even when cold water is only connected.

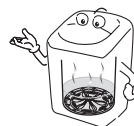

Normal logic control

- A built-in load sensor automatically detects and measures the laundry load and a microprocessor optimizes washing conditions such as ideal water consumption and washing time.
- Advanced technology is built into the Electronic Control System which ensures the best washing result.



New DD type washing with fabric care



Affective agitation accelerates detergent dissolving and improves detergent penetration into the clothes.



The half cycle rotations of the wash tub helps improve stain removal.



The Waveforce action allows greater soil removal by creating centrifugal water forces which also helps reduce clothes wear due to washing



The half cycle rotations of the tub also helps balance the load and reduce tangling.

Low Noise Direct Drive System

- The advanced Brushless DC motor rotates the Tub directly without the need of belts or clutches. thereby reducing the noise of the washer.
- The washing machine adjusts to the optimum rotating speeds according to the type of clothing in the load.



SmartDiagnosis™

- Should you experience any technical difficulty with your washing machine, it has the capability of transmitting data by phone to the Customer Information Center. The Consultant records the data transmitted from your machine and uses it to analyze the issue, providing a fast and effective diagnosis.



Tag On function

- The Tag On function allows you to conveniently use the LG Smart Diagnosis™, Cycle Download, Laundry Stats and Tag On Cycle Set features to communicate with your appliance right from your own smart phone.



Contents

READ THIS MANUAL

Inside you will find many helpful hints on how to use and maintain your washer properly. Just a little preventive care on your part can save you a great deal of time and money over the life of your washer. You will find many answers to common problems in the Troubleshooting section. If you review our chart of Troubleshooting Tips first, you may not need to call for service at all.

Introduction	Safety Information	4
	Identification of Parts	7
	Function Information	8
Before Starting to Wash	Preparation Before Washing	9
	Use of Water, Dispenser Drawer, Detergent, Bleach and Softener	10
	Special Guide for Stain Removal	13
	Function of each Button	14
Washing Programs	Cotton Wash	16
	Stain Care Wash	16
	Allergy Care Wash	16
	Extra Rinse	16
	Eco Cotton	16
	Quick Wash	18
	Delicates Wash	18
	Towels Wash	18
	Duvet Wash	18
	Quiet Wash	18
	Soak Wash	20
	Intensive Rinse	21
Tub Clean	22	
Additional Function Program	Air Dry	23
	Option Washing	24
	Time Delay (RESERVATION) Wash	25
	Other Useful Functions	26
	Using Tag On Function	27
Installation	Placing and Leveling	30
	Connecting Water Supply Hose	31
	Connecting the Drain Hose	34
Care and Maintenance	Cleaning and Maintenance	35
	Soft Safety Door (where fitted)	37
Troubleshooting	Common washing problems	38
	Troubleshooting	39
	SmartDiagnosis™	40
Specification	Specification	41

Safety Information

Read carefully and thoroughly through this booklet as it contains important safety information that will protect the user from unexpected dangers and prevent potential damages to the product.

This booklet is divided into 2 parts : Warning and Caution.



: This is a warning sign specifying user's applications which might be dangerous.





: This is a sign specifying 'Strictly Forbidden' applications.



WARNING : Failure to comply with the instructions under this sign may result in major physical injuries or death.



CAUTION : Failure to comply with the instructions under this sign may result in minor physical injuries or product damages.

<p>WATER HEATER SAFETY</p>	<p> WARNING</p> <ul style="list-style-type: none"> • Under certain conditions hydrogen gas may be produced in a water heater that has not been used for two weeks or more. Hydrogen gas can be explosive under these circumstances. If the HOT water has not been used for two weeks or more, prevent the possibility of damage or injury by turning on all Hot water faucets and allowing them to run for several minutes. Do this before using any electrical appliance which is connected to the HOT water system. This simple procedure will allow any built-up hydrogen gas to escape. Since the gas is flammable, do not smoke or use an open flame or appliance during this process.
<p>PROPER INSTALLATION</p>	<p> CAUTION</p> <ul style="list-style-type: none"> • The base opening must not be obstructed by carpeting when the washing machine is installed on a carpeted floor. This washer should not be used in any mobile application. • Install or store where it will not be exposed to temperatures below freezing or exposed to the weather. If the product is exposed to such conditions, electric shock, fire, break down or deformation may occur. • Properly ground washer to conform with all governing codes and ordinances. Follow details in Installation Instructions. If not grounded properly, break down and leakage of electricity may occur, which may cause electric shock. • Must be positioned so that the plug is accessible. If the plug is placed between the wall and the machine, it may get damaged, possibly causing fire or electric shock. • Make sure the plug is completely pushed into the outlet. Failure to do so may cause electric shock and fire due to overheating. • This machine must not be installed outdoors, in a humid environment or in any sheltered outdoor area where it is subject to weathering conditions.

Safety Information

YOUR LAUNDRY AREA



Warning

- Keep the area underneath and around your appliances free of combustible materials such as lint, paper, rags, chemical, etc.

Operating with such materials around the machine may trigger explosion or fire.

- Close supervision is necessary if this appliance is used by or near children. Do not allow children to play on, with, or inside this or any other appliance.
There is potential danger that children might drown in the tub.



Do not touch the power plug with a wet hand.

It will cause electric shock



Do not put your hand, foot or anything under the washing machine while the washing machine is in operation.

There is a rotating mechanism under the machine, so you could be injured.

WHEN USING THE WASHER



Caution

- Use this appliance only for its intended purpose as described in this Owner's Manual.
- The laundry process can reduce the flame retardancy of fabrics. To avoid such a result, carefully follow the garment manufacturer's wash and care instructions.
- To minimize the possibility of electric shock, unplug this appliance from the power supply or disconnect the washer at the household distribution panel by removing the fuse or switching off the circuit breaker before attempting any maintenance or cleaning.
- Do not place hands into the tub while it is rotating. Doing so can cause serious injury. The machine should only be used for domestic household applications. Do not use the washer for washing rugs, mats, shoes or pet blankets.

NOTE : Pressing Power button to turn off does NOT disconnect the appliance from the power supply.

- Make sure that drainage is working properly.
If water is not drained properly, your floor may get flooded. Flooded floors may induce electricity leakage, further resulting in electric shock or fire.
- If, during spinning, opening the lid does not stop the tub within about 15 seconds, immediately discontinue operating the machine.
Call for repair. A machine that spins with its door open may cause injuries.



Never reach into washer while it the tub is still spinning.

Wait until the machine has completely stopped before opening the lid.

Even slow rotation can cause injury.



Never attempt to operate this appliance if it is damaged, malfunctioning, partially disassembled, or has missing or broken parts, including a damaged cord or plug.









Operating with a damaged plug may cause electric shock.



Do not use water hotter than 65°C.

Use of excessively hot water may cause damage to delicate fabrics or cause leakage of water.

Safety Information

<p>WHEN USING THE WASHER</p>	<p> WARNING</p> <p> Do not use a plug socket and wiring equipment for more than their rated capacity. Exceeding the limit may lead to electric shock, fire, break down, and/or deformation of parts.</p> <p> Do not mix chlorine bleach with ammonia or acids such as vinegar and/or rust remover. Mixing different chemicals can produce toxic gases which may cause death.</p> <p>Do not wash or dry articles that have been cleaned in, washed in, soaked in, or spotted with combustible or explosive substances (such as wax, oil, paint, gasoline, dry-cleaning solvents, kerosene, etc). Do not add these substances to the wash water.  Do not use or place these substances around your washer or dryer during operation. They may ignite causing an explosion or fire.</p>
<p>WHEN NOT IN USE</p>	<p> CAUTION</p> <ul style="list-style-type: none">• Turn off water faucets to relieve pressure on hoses and valves and to minimize leakage if a break or rupture should occur. Check the condition of the fill hoses; they may need replacement after 5 years.• When the air temperature is high and the water temperature is low, condensation may occur and thus wet the floor.• Wipe off dirt or dust on the contacts of the power plug. Using unclean power plug may cause fire.• Before discarding a washer, or removing it from service, remove the washer lid to prevent children from hiding inside. Children may be trapped and suffocated if the lid is left intact. <p>Do not attempt to repair or replace any part of this appliance unless specifically recommended in this Owner's Manual, or in published user-repair instructions that you understand and have the skills to carry out.  Operating the machine with improperly replaced parts may be a cause for fire or electric shock.</p> <p> Do not tamper with controls. It may lead to electric shock, fire, break down, deformation.</p> <p>Do not yank the power cord in an attempt to disconnect the power plug.  Securely hold the power plug to unplug the machine. Failure to observe these instructions may cause electric shock or fire due to short-circuit.</p> <p> When you are cleaning the washing machine, do not apply water directly to any part of the washing machine. It will cause short circuit and electric shock.</p>

Identification of Parts

Body

* Picture might be different by model.

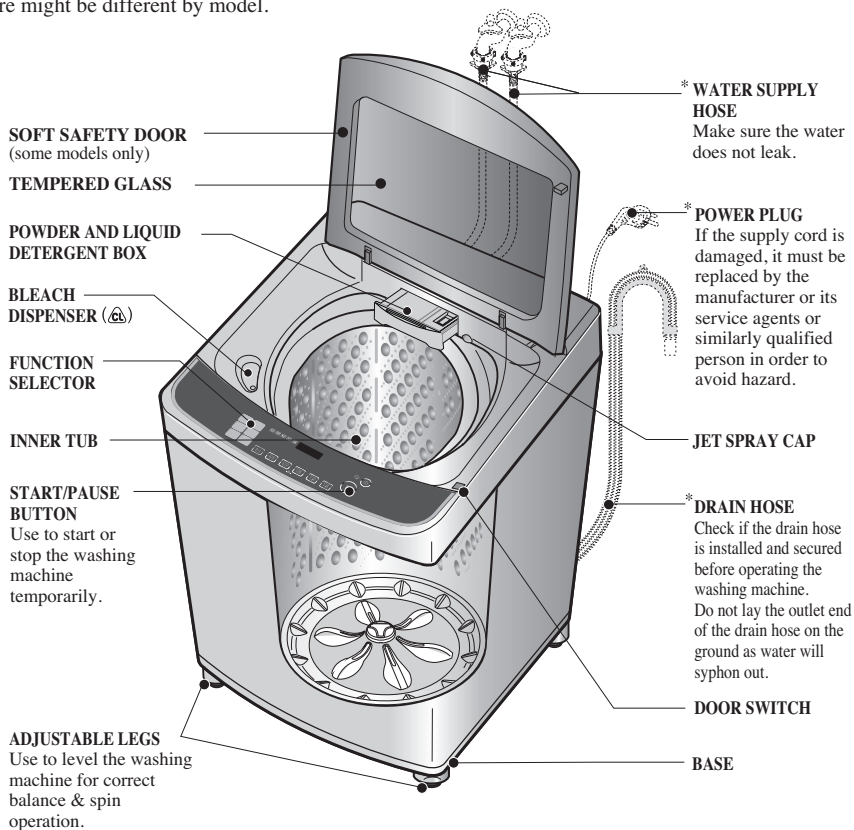

Accessories

Height adjustment plate



2 Pieces

Water supply hoses
(same for Hot & Cold)

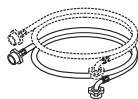

Drain hose



NOTE

* * Part can be different according to the model.

Function Information

Our machine provides various washing methods which suits various conditions and types of laundry.

Different types of laundry washing

Cotton Wash

Use this Program for everyday washing e.g. sheets, towels, T-shirts. *(refer to page 16)*

Stain Care Wash

Washing is the best temperature (40 degrees) by heating the clean clothes when you want to use. *(refer to page 16)*
(Proper Water Temp. Hot:60°C / Cold:15 °C)

Allergy Care Wash

This cycle is a powerful, high temperature cycle designed specifically to reduce certain allergens. *(refer to page 16)*
(Proper Water Temp. Hot:60°C / Cold:15 °C)

Extra Rinse

Use this program to get better rinsing performance. *(refer to page 16)*

Eco Cotton

For a normally soiled cotton load. *(refer to page 16)*

Quiet Wash

Use this program to wash quietly at night. *(refer to page 18)*

Duvet Wash

Use for blankets or duvet with care labels that indicate hand wash. *(refer to page 18)*

Towels Wash

Use this program to wash Towels, Sheets, mixed cotton loads. *(refer to page 18)*

Delicates Wash

Wool clothes (lingerie, wool, etc.) which may be easily damaged and should be washed according to their care label. *(refer to page 18)*
The fibers of machine washable wools have been specifically modified to prevent felting when they are machine washed.
Most handknitted garments are not made of machine washable wool and we recommend that you hand wash them

- Before washing your wools check the care label for the washing instructions.
- When washing wools use a mild Detergent recommended for washing wool.
- Hand washed wools may be spun in a washing machine to reduce the time they take to dry.
- To dry wools lay down them flat on a towel and pat into shape. Dry wools out of direct sunlight. (The heat and tumble action of a dryer may cause shrinkage or felting of woolen garments.) Some wool underlays and sheepskin products can be washed in a washing machine but may cause pump blockages. (Ensure that the whole article is suitable for machine washing and not just the backing material.) You may wish to handwash these articles and place them in the machine to spin dry.

Washing according to the condition of laundry

Quick Wash

Quick Wash can be selected to wash lightly soiled clothes of less than 3.0 kg in a short time. *(refer to page 18)*

Soak Wash

Soak Wash can be selected to wash heavily soiled laundry by soaking in water for some time to remove dirt and grime. *(refer to page 20)*

Intensive Rinse

Use Intensive Rinse to remove detergents more effectively. *(refer to page 21)*

Other washing options

Tub Clean

Use this program to clean the inside of washing machine especially Inner tub & Outer tub . *(refer to page 22)*

Time Delay (RESERVATION) Wash

Time Delay (RESERVATION) Wash is used to delay the finishing time of the operation.
The number of hours to be delayed can be set by the user accordingly. *(refer to page 25)*

Option Wash

When the user needs only Spin, Rinse/Spin, Rinse, Wash/Rinse, Wash, Wash/Rinse/Spin, Soak/Wash/Rinse/Spin *(refer to page 24)*

Preparation Before Washing

Care Labels

* Look for a care label on your clothes. This will tell you about the fabric content of your garment and how it should be washed.

Sort clothes into loads that can be washed with the same wash cycle, Water Temperature and spin speed.



Sorting

To get the best results, different fabrics need to be washed in different ways.

- **SOIL** (Heavy, Medium, Light) Separate clothes according to the type and amount of soil.
- **COLOUR** (Whites, Lights, Darks) Separate white fabrics from colored fabrics.
- **LINT** (Lint producers, Collectors) Separate lint producers and lint collectors.
Lint Producers Terry cloth, Chenille, Towels, Nappies, Diapers
Lint Collectors Synthetics, Corduroy, Permanent Press, Socks



Check before Loading

- **Check all pockets to make sure that they are empty.** Things such as nails, hairclips, matches, pens, coins, and keys can damage both your washer and your clothes.
- **Mend any torn garments or loose buttons.** Tears or holes may become larger during washing.
- Remove belts, underwires, etc. to prevent damage to the machine or your clothes.
- **Pretreat any dirt and stains.**
- Make sure the clothes are washable in water.
- Check the washing instructions.
- Remove tissue from pockets.



⚠ CAUTION

Do not wash or spin any item labeled or known to be water-proof or water-resistant, even if the product care label on the item permits machine washing. Failure to follow these instructions could result in severe damage to your laundry, your washer and/or property damage as a result of abnormal vibration of the washer.

- Examples of water-proof or water-resistant items include certain mattress pads, mattress covers, rain gear, camping gear, skiing apparel, outdoor gear and similar items.

Pretreatment on stains or heavy soil

- Pretreat shirt collars and cuffs with a pre-wash product or liquid Detergent when placing them in the washer. Before washing treat special stains with bar soaps, liquid Detergent or a paste of water and granular Detergent.
- Use a pretreat soil and stain remover.
Treat stains AS SOON AS POSSIBLE. The longer they are left the harder they are to remove. *(For more detail refer to page13)*

Loading

Do not wash fabrics containing flammable materials (waxes, cleaning fluids, etc.).

Load Size

The WATER LEVEL should just cover the clothes. Adjust the load size accordingly. Loosely load clothes no higher than the top row of holes in the washer tub. To add items after washer has started, press Start button and submerge additional items. Close the lid and press Start button again to restart.

Light and Large-sized clothing

Clothes like downs and woollens are light weight, large and float easily. Use a nylon net and wash them in a small amount of water. If the laundry floats during the wash cycle, it may become damaged. Use dissolved Detergent to prevent the Detergent from clumping.

Long laundry items

Use nylon nets for long, DELICATE items. For laundry with long strings or long length, a net will prevent tangling during washing. **Fasten zippers, hook, and strings** to make sure that these items don't snag on other clothes.

※ Nylon net is not supplied by LG.

⚠ WARNING

Fire Hazard

Never place items in the washer that are dampened with gasoline or other flammable fluids. No washer can completely remove oil. Do not dry anything that has ever had any type of oil on it (including cooking oils). Doing so can result in death, explosion, or fire.



Use of Water, Dispenser Drawer, Detergent, Bleach and Softener

Using Water

Amount of WATER LEVEL

- This machine detects the weight of the laundry automatically, then sets the Water Level and indicates the recommended amount of detergent to be added by the detergent level indicator.
- When you select a wash program, the Water Level will be shown on the control panel.
- The following table shows the amount of water.
- When the Water Level is automatically detected, it may differ depending on the quantity of laundry even though the same Water Level is indicated on the control panel. If bulky light weight items are loaded, then it may be necessary to increase the water level manually.

9	10	
7	8	
5	6	
3	4	
1	2	

NOTE

[Minimum water amount]

The washer has the ability to detect the weight of the clothes to determine the appropriate water level, but cannot detect the volume of clothes, therefore it will be necessary to increase the water level manually to avoid linting and tangling when washing bulky light weight loads.

Water Temperature

- The machine sets the appropriate temperature automatically according to the wash program .
- The temperature of the water impacts the effectiveness of all laundry additives and therefore, the cleaning results.
We recommend temperatures of:
 - HOT 49~60°C White items, nappies underclothing and heavily soiled, colorfast items.
 - WARM 29~40°C Most items
 - COLD* 18~24°C Only very bright colors with light soil.
- When washing in COLD water additional steps may be needed:
 - Adjust Detergent amount and pre-dissolve Detergent in WARM water
 - Pretreat spots and stains
 - Soak heavily soiled items
 - Use appropriate bleach

* Temperature below 18°C will not activate laundry additives and may cause linting & soap residue, poor cleaning, etc. In addition, Detergent manufactures and care labels define COLD water as 26~29°C.

If the temperature of the water in the tub is too cold for your hands, the Detergent will not activate and clean effectively.

NOTE

If iron is present in the water the clothes may become an all-over yellow or they may be stained with brown or orange spots or streaks. Iron is not always visible. Installation of a water softener or an iron filter may be necessary for severe cases.

Using Dispenser Drawer

Using the Dispenser Drawer

- Liquid Fabric Softener
 - Liquid or Powder Low-Sudsing, High-Efficiency Detergent
- The dispenser automatically dispenses additives at the proper time in the wash cycle.
1. Slowly open the dispenser drawer by pulling the drawer out until it stops.
 2. After adding laundry products, slowly close the dispenser drawer. Closing the drawer too quickly could result in early dispensing of additives.
- Avoid overfilling or splashing when adding laundry products to the dispenser. Doing so could result in early dispensing of laundry products.

At the end of the cycle, you may see water in the compartments. This is part of the normal operation of the washer.

NOTE : Do not use bleach in the dispenser drawer. Powdered detergent should only be used in the soap dispenser compartment. For optimum results, it may be necessary to dilute the Liquid Fabric softener before adding it to the softener dispenser.

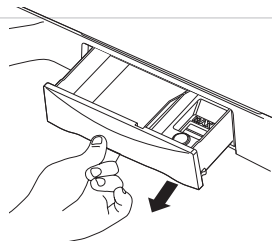

Using Detergent

Detergent

Follow the Detergent package directions. Using too little Detergent is a common cause of laundry problems. Use more Detergent if you have hard water, large loads, greasy or oily soils or lower Water Temperature.

Choosing the right Detergent

We recommend the use of domestic Detergent, (powder, liquid or concentrated). Soap flakes or granulated soap powders should not be used in your washing machine. When washing woolens remember to use Detergent suitable for washing woolens.

How much Detergent

The correct amount of Detergent will vary depending on the amount of soil in your clothes (Jeans and work clothes may need more Detergent, while bath towels usually need less.).

For liquid and concentrated Detergents, follow the recommendations of the Detergent manufacturer.

Note: To check that you are using the correct amount of Detergent, lift the lid of your machine about half-way through the wash. There should be a thin layer of foam over the surface of the water. Lots of foam may look good, but it does not contribute to cleaning your clothes. No foam means not enough Detergent has been used; soil and lint can settle back on the clothes or the washing machine. If excess Detergent is used, the rinse will not be as clean and efficient. Also, it could cause environmental pollution, so use it accordingly.

Adding Detergent

Add measured powdered detergent to the detergent compartment of the dispenser drawer.

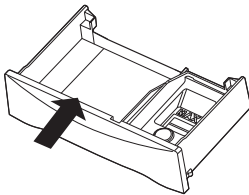

The dispenser drawer **MUST ALWAYS** be in place before you start your washer

Detergent usage may need to be adjusted for water temperature, water hardness, size and soil level of the load. Avoid using too much detergent in your washer, as it can lead to oversudsing and detergent residue being left on the clothes.

Note : Using Liquid detergent

- Dilute Liquid detergent with water and pour into the tub, start the cycle.
- Delay wash course is not available if you use liquid detergent.



Attention

Using liquid detergent without diluting, or leaving laundry for a long time after pouring diluted liquid detergent into the tub might cause damage, bleaching or discoloration of the clothes.

Use of Water, Dispenser Drawer, Detergent, Bleach and Softener

Using Liquid Bleach

- Check clothing care label for special instructions and separate the laundry to be bleached
- Dilute liquid chlorine bleach.
- Measure the recommended amount of liquid bleach carefully following instructions on the bottle.
- Before starting the washer, pour measured amount of bleach directly into bleach dispenser. Avoid splashing or overfilling. Powdered bleach should be mixed with water before pouring.

Bleach dispenser (㉔)

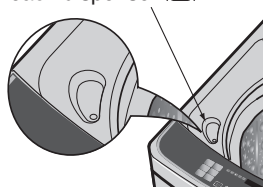

NOTE

- Never pour undiluted liquid bleach directly onto clothes or into the wash basket. This may cause change of color or damage the laundry.
- Do not pour powdered bleach into bleach dispenser.

Using Fabric Softener

If desired, pour the recommended amount of liquid fabric softener into the right-hand compartment.

Use only liquid fabric softener.

Dilute with water to the maximum fill line.

- Do not exceed the maximum fill line.

Overfilling can cause early dispensing of the fabric softener, which could stain clothes.

NOTE : Do not pour fabric softener directly on the wash load. It may stain the clothes.

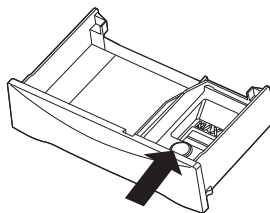

Attention

- Do not mix with Detergent or bleach.
- Never pour fabric softener directly on clothes. It may stain them.
- Do not stop the washer during the first spin for timely dispensing.
- Option washing is not designed to be used with fabric softener dispenser.

Scrud(Waxy Build up)

Scrud is the name given to the waxy build-up that can occur within any washer when the fabric softener comes into contact with Detergent. This build-up is not brought about by a fault in the machine.

If scrud is allowed to build-up in the machine it can result in stains on your clothes or an unpleasant smell in your washer.

If you wish to use fabric softener we recommend

- Using fabric softener sparingly.
- When filling the dispenser, do not splash or overflow.
- Clean dispenser as soon as the cycle is finished.
- Clean your machine regularly. (refer to page 22 or 36)
- Cold water washing increases the chance of this build-up occurring. We recommend a regular WARM or HOT wash e.g. every 5th wash should be at least a warm one.
- Fabric softener with a thinner consistency is less likely to leave residue on the dispenser and contribute to a build-up.

Special Guide for Stain Removal

▲ WARNING

- Do not use or mix liquid chlorine bleach with other household chemicals such as toilet cleaners, rust removers, acid or products containing ammonia. These mixtures can produce dangerous fumes which can cause serious injury or death.
- To reduce the risk of fire or serious injury to persons or property, comply with the basic warnings listed below:
 - Read and comply with all instructions on stain removal products.
 - Keep stain removal products in their original labeled containers and out of children's reach.
 - Thoroughly wash any utensil used.
 - Do not combine stain removal products, especially ammonia and chlorine bleach. Dangerous fumes may result.
 - Never wash items which have been previously cleaned in, washed in, soaked in or spotted with gasoline, dry cleaning solvents or other flammable or explosive substances because they give off vapors that could ignite or explode.
 - Never use highly flammable solvents, such as gasoline, inside the home. Vapors can explode on contact with flames or sparks.

For successful stain removal:

- Remove stains promptly.
- Determine the kind of stain, then follow the recommended treatment in the stain removal chart below.
- To pretreat stains, use a prewash product, liquid Detergent, or a paste made from granular Detergent and water.
- Use COLD water on unknown stains because HOT water can set stains.
- Check care label instructions for treatments to avoid on specific fabrics.
- Check for colorfastness by testing stain remover on an inside seam.
- Rinse and wash items after stain removal.



Follow fabric care label instructions

Stain Removal	
STAIN	TREATMENT
Adhesive tape, chewing gum, rubber cement	Apply ice. Scrape off excess. Place stain face down on paper towels. Saturate with prewash stain remover or nonflammable dry cleaning fluid.
Baby formula, dairy products, egg	Use product containing enzymes to pretreat or soak stains.
Beverages (coffee, tea, soda, juice, alcoholic beverages)	Pretreat stain. Wash using COLD water and bleach safe for fabric.
Blood	Rinse with COLD water. Rub with bar soap. Or pretreat or soak with product containing enzymes. Wash using bleach safe for fabric.
Candle wax, crayon	Scrape off surface wax. Place stain face down between paper towels. Press with warm iron until wax is absorbed. Replace paper towels frequently. Treat remaining stain with prewash stain remover or nonflammable dry cleaning fluid. Wash using bleach safe for fabric.
Chocolate	Pretreat or soak in WARM water using product containing enzymes. Wash using bleach safe for fabric.
Collar or cuff soil, cosmetics	Pretreat with prewash stain remover or rub with bar soap.
Dye transfer on white fabric	Use packaged color remover. Wash using bleach safe for fabric.
Grass	Pretreat or soak in WARM water using product containing enzymes. Wash using bleach safe for fabric.
Grease, oil, tar (butter, fats, salad dressing, cooking oils, car grease, motor oils)	Scrape residue from fabric. Pretreat. Wash using hottest water safe for fabric. For heavy stains and tar, apply nonflammable dry cleaning fluid to back of stain. Wash towels with stains frequently. Rinse thoroughly. Wash using hottest water safe for fabric.
Ink	Some inks may be impossible to remove. Washing may set some inks. Use prewash stain remover, denatured alcohol or nonflammable dry cleaning fluid.
Mildew, scorch	Wash with chlorine bleach if safe for fabric. Or, soak in oxygen bleach and HOT water before washing. Badly mildewed fabrics may be permanently damaged.
Mud	Brush off dry mud. Pretreat or soak with product containing enzymes.
Mustard, tomato	Pretreat with prewash stain remover. Wash using bleach safe for fabric.
Nail polish	May be impossible to remove. Place stain face down on paper towels. Apply nail polish remover to back of stain. Repeat, replacing paper towels frequently. Do not use on acetate fabrics.
Paint, varnish	WATER BASED : Rinse fabric in cool water while stain is wet. Wash. Once paint is dry, it cannot be removed, OIL BASED AND VARNISH : Use solvent recommended on can label. Rinse thoroughly before washing.
Rust, brown or yellow discoloration	For spots, use rust remover safe for fabric. For discoloration of an entire load, use phosphate Detergent and nonchlorine bleach. Do not use chlorine bleach because it may intensify discoloration.
Shoe polish	LIQUID : Pretreat with a paste of granular Detergent and water. PASTE : Scrape residue from fabric. Pretreat with prewash stain remover or nonflammable dry cleaning fluid. Rub Detergent into dampened area. Wash using bleach safe for fabric.

Function of each Button

Time Delay (Reservation) button

- Use for laundry reservation.
- To cancel, press the power button. (refer to page 25)

Wash Status display

- Laundry progress is indicated here.
- A flashing indicator means that the process is in operation, an indicator which is on but not flashing means it is awaiting that process and process indicators that are not lit means that the process is complete or was not selected.

Remaining wash, reservation time, and error message display

- During operation this indicates the remaining wash time.
- If there is a malfunction, the error message will be displayed to assist in troubleshooting the problem.

Vapour Mode button

- Vapour Mode can be selected with the Stain Care and Cotton Wash courses. It increases the wash temperature to 60Deg C for a short period of the wash cycle.
- Vapour Mode is automatically selected with the Allergy care course.

Intensive Wash button

- Allows a higher agitation intensity.
- It is set to Medium intensity by default (Select is off.) Select Intensive Wash by pressing the button. (Can be set on all courses except Delicates, Allergy Care, Quiet Wash and Tub Clean.)

Hot and cold wash laundry button

- To select hot water, cold water, or warm water washing.
- Can be changed during operation.
- If hot wash is selected, laundry will be done with hot water and rinse will be done with cold water.
- The preset water temperature for Delicates is Cold water only. (The laundry can be damaged if Hot water is used)
- Warm water (Hot + Cold Wash) is automatically selected on the Stain care, Allergy Care, Extra Rinse and Tub Clean cycles.

Water Level button and Detergent amount indicator

- Press to manually select the Water Level.
- It can be changed during operation.
- Detergent indicator suggests the recommended powdered detergent amount to add.

NOTE

- * For optimizing the washing algorithm, the displayed time may change during washing-increased by a maximum of 10 minutes (not including spin irregularity correction time) or decrease by a maximum of 4 minutes.
- * The Vapour Mode option cannot be used with all cycles.
- * Vapour may not be clearly visible during the Vapour Mode cycles. This is normal. Too much vapour could damage clothing.
- * Do not use Vapour Mode with delicate fabrics such as wool, silk, or easily discolored fabrics.

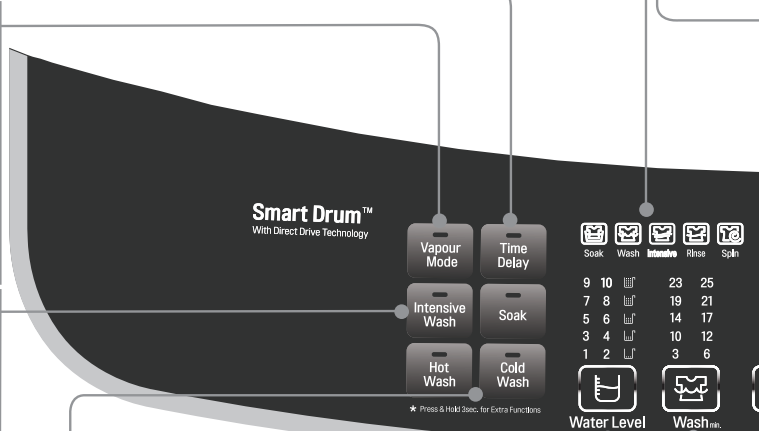

Air dry

- To shorten dry time.
- Press the Spin button for 3 seconds to select, press power button to deselect. (refer to page 23)

START/PAUSE button

- Use to start or pause the washing process.
- After 4 minutes in pause status, the washer will automatically turn off.

SmartDiagnosis™ Function Display

- It marks the place to put the phone to receive the SDS signals when prompted to by a Customer Care Consultant. (refer to page 40)

Power button

- Use to turn the power on or off.
- Push again and power goes on or off.
- The power turns off automatically about 10 seconds after the wash is finished.

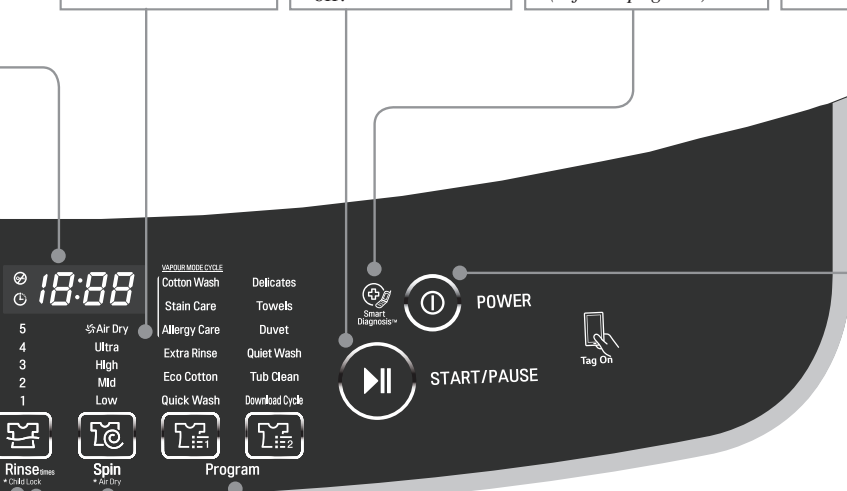

Wash, Rinse, Spin button

- To change the wash time, number of rinses, strength of spin dry.
- Increase the amount of Rinses to effectively remove detergent residue.

Child lock function

- Stops any accidental changes by making the keypad inoperative.
- Press 'Rinse' button for 3 seconds to select or deselect. (refer to page 26)

Program button























- Selects the Wash cycle course.
- Select the appropriate wash Cycle to suit the clothes type and soil level.

















⚠ WARNING

- Do not touch the lid during Vapour Mode cycles. The lid Surface can become warm.. Allow the lid lock to release before opening the door.
- Do not attempt to override the lid lock mechanism or reach into the washer during a Vapour Mode cycle.























- * For optimal Vapour cleaning performance, limit laundry loads to 4 kg or less.
- * When the Vapour mode option is selected for the Medium Soiled the water level will not exceed level '7' in order to maintain optimal performance.
- * The control panel may differ according to different models.

















Washing Programs

Washing Programs	 POWER	Add the laundry	  Program	Add the Detergent
<p>Cotton Wash</p> <p>Used for Cotton wash loads, this mode automatically selects the most appropriate conditions and completes the sequence in one operation. The built-in sensor detects the weight of the load and the ideal wash power and wash, rinse and spin times are set accordingly.</p>				 <ul style="list-style-type: none"> The water will commence filling when the wash cycle begins.
<p>Stain Care</p> <p>Is best used when a hygienic wash is required. The internal heater heats the water if necessary to 40 degrees during the main wash. Vapour Mode can be selected with the Stain Wash Program to increase the wash temperature briefly to 60 Deg C.</p>		 <ul style="list-style-type: none"> Do not load more than 5kg. 	 <ul style="list-style-type: none"> Select the Stain Care program on the Control panel. 	 <ul style="list-style-type: none"> Add the appropriate quantity of Detergent As indicated by the Water Level. Or follow the Detergent Manufacturer's instructions.
<p>Allergy Care</p> <p>This cycle is a powerful, high temperature cycle designed specifically to reduce certain allergens. The water temperature for a brief period of the wash cycle will be 60Deg C</p>		 <ul style="list-style-type: none"> Do not load more than 4kg. 	 <ul style="list-style-type: none"> Select the Allergy Care program on the Control panel. 	 <ul style="list-style-type: none"> Add the appropriate quantity of Detergent As indicated by the Water Level. Or follow the Detergent Manufacturer's instructions.
<p>Extra Rinse</p> <p>Use this program to increase rinsing performance. This would include underwear and baby clothes. If someone has sensitive skin then this program is recommended to be used.</p>			 <ul style="list-style-type: none"> Select the Extra Rinse program on the Control panel. 	 <ul style="list-style-type: none"> Add designated amount of detergent by Water Level and close the door. Use exclusive neutral detergent or dry detergent.
<p>Eco Cotton</p> <p>Eco Cotton cycle consumes less water and electricity to wash normally Soiled cotton loads.</p>			 <ul style="list-style-type: none"> Select the Eco Cotton program on the Control panel. 	 <ul style="list-style-type: none"> Add the appropriate quantity of Detergent as indicated by the Detergent level indicator. Or follow the Detergent manufacturer's instructions.











Close the lid	 START/PAUSE	Finish	Caution & Note
 <ul style="list-style-type: none"> The water will commence filling when the wash cycle begins. 	 <ul style="list-style-type: none"> The tub will repeatedly rotate briefly to detect the weight of the clothes and indicate the set water level. The water level can then be manually increased if necessary. The Detergent level indicator will suggest the detergent amount that should be added. 	 <ul style="list-style-type: none"> When the wash program ends, the buzzer will ring for 10 seconds before the Power goes off automatically. 	<ul style="list-style-type: none"> If water is already in the tub, or putting wet laundry into the tub before starting will increase the Water Level. With lightweight bulky loads, Water Level can be set low. Changes to Water Temperature (Hot Wash/Cold Wash) and wash level are possible during operation. (refer to page 10)
			<ul style="list-style-type: none"> Stain care 40 degree course selects both Hot and Cold water when filling. When the water is filling, the Hot and Cold valves may turn on and off repeatedly to achieve the 40 degrees. The internal heater may operate if necessary. ※ Stains that easily removed at 40°C: coffee, cola, orange juice, grape juice, soy sauce etc. If only hot wash is selected, the wash time will be reduced as heating time is shortened, however this can damage clothes if the temperature of the hot water tap is too hot. If only cold water is connected, the wash time is longer as heating time lengthens. Uses cold water and hot water together. While heating, the wash tub will rotate slowly. This is a part of normal operation. While heating, because of humidity condensation may form on the glass door. This is normal. Just wipe it after the washing has ended. It is normal for the exterior of the machine to become warm.
			<ul style="list-style-type: none"> Allergy Care course selects both Hot and Cold water when filling. When the water is filling, the Hot and Cold valves may turn on and off repeatedly to achieve the 60 degrees. The internal heater may also operate if necessary. ※ Stains that easily removed at 60°C: milk, blood, sebum, egg, animal fat and vegetable oil. If only Hot Wash is selected, the wash time will be reduced as heating time shortens. If only Cold water is connected, the wash time is longer as heating time lengthens. Uses cold water and hot water together. While heating, the wash tub will rotate slowly. This is a part of normal operation. While heating, because of humidity condensation may form on the glass door. This is normal. Just wipe it after the washing has ended. It is normal for the exterior of the machine to become warm. The Allergy Care course can reduce allergens in bedding and clothing. Due to the higher energy and temperatures used, the Allergy Care course is not recommended for wool, silk, leather, or any other delicate or temperature sensitive items.
			<ul style="list-style-type: none"> During Rinse, the tub will rotate slowly while water is supplied. The water will drain out after each rise. During spray rinse, it is normal for the water to be drained out simultaneously.
			<p>INFORMATION FOR ENERGY TEST</p> <ul style="list-style-type: none"> Select the water temperature to suit wash cycles. Always follow garment manufacturer's care label or instructions when washing. Set program of Eco cotton, Spin Ultra, Rinse 5, Wash 6, Water Level 2, Cold Wash, Hot Wash, Soak 1:00 is for normally soiled load and testing in accordance or in conformity with AS/NZS 2040. 1. The test results depend on water pressure, water hardness, water inlet temperature, room temperature, type and amount of load, degree of soiling utilized detergent, fluctuations in the main electricity supply and chosen additional options. For best washing results, we recommend dilute the detergent powder (Drum Type) in WARM water and pour directly into tub.

Washing Programs











Washing Programs	 POWER	Add the laundry	  Program	Add the Detergent
<p>Quick Wash</p> <p>Use this cycle when washing lightly soiled clothes for a short time. This cycle is most effective and should only be used with loads weighing less than 3.0kg.</p>			 <ul style="list-style-type: none"> Select the Quick Wash program on the Control panel. 	 <ul style="list-style-type: none"> Add the appropriate quantity of Detergent as indicated by the Detergent level indicator. Or follow the Detergent manufacturer's instructions.
<p>Delicates</p> <p>Use this program for washing delicate fabrics such as lingerie and woolens. (wash only "water washable" clothes) Before washing your woolens check the care label for the washing instructions.</p>			 <ul style="list-style-type: none"> Select the Delicates program on the Control panel. 	 <ul style="list-style-type: none"> Use neutral Detergent appropriate for the clothes. When washing woolens use a mild Detergent recommend-ed for washing wool.
<p>Towels</p> <p>Use this cycle for Bath towels, bath robes, hand towels etc.</p>			 <ul style="list-style-type: none"> Select the Towels program on the Control panel. 	 <ul style="list-style-type: none"> Add the appropriate quantity of Detergent As indicated by the Detergent level indicator. Or follow the Detergent Manufacturer's instructions.
<p>Duvet</p> <p>Use for blanket or bedclothes or pillow and quilt covers.</p>			 <ul style="list-style-type: none"> Select the Duvet program on the Control panel. 	 <ul style="list-style-type: none"> Pour the detergent directly into the tub after dissolving it with warm water. if Cold water washing can cause detergent residue to remain.
<p>Quiet Wash</p> <p>Use this program to wash quietly in Silent especially during late night and early morning when less noise is preferable.</p>			 <ul style="list-style-type: none"> Select the Quiet wash program on the Control panel. 	 <ul style="list-style-type: none"> Add the appropriate quantity of Detergent as indicated by the Detergent level indicator. Or follow the Detergent manufacturer's instructions.

Close the lid	 START/PAUSE	Finish	Caution & Note
			
			<ul style="list-style-type: none"> • Lay out onto a cool floor or on a hanger covered by a towel to dry these type of clothes. • The Spin intensity or spinning time cannot be changed in this cycle as higher spin speeds can damage delicate clothing.
			<ul style="list-style-type: none"> • When washing bulkier loads the water level should be manually increased to reduce linting and detergent residue.
			<ul style="list-style-type: none"> • Cashmere bedclothes, acrylic blanket, mixed spinning blanket, woolen blanket, infilling (polyester 100), and bed sheets may be damaged if not washed in laundry nets or bags. • Separate bed clothes from general clothes. They may become entangled or ball together and cause abnormal washing, especially if the water level is too low. It can be increased manually during the wash. • Spin dry may take longer if the load becomes lumped together and then attempted to be automatically corrected by the machine, by refilling with water. • Never wash electric blankets, mats, rugs or shoes in the machine as it will cause a malfunction and can damage the machine. • Use laundry bags or nets with items that can inflate with air and float during the wash.
			<ul style="list-style-type: none"> • Quiet wash program has a longer washing time than the Cotton Wash program. • To reduce the overall noise during spin, the spin speed is reduced, therefore the clothes will have a higher moisture level at the end of the wash.

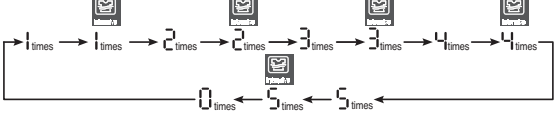
Soak Wash

<p>1</p>  <p>POWER</p>	<p>Press the POWER button to turn power on.</p>
<p>2</p>   <p>Program</p>	<p>Load the clothes and Press the Program button to select the Washing Program.</p> <ul style="list-style-type: none">• Soak is not selectable with the Stain Care, Allergy Care, Delicates, Quick Wash and Tub clean programs.
<p>3</p>  <p>Soak</p>	<p>Press the Soak button.</p> <ul style="list-style-type: none">• “Soak” can be selected by pressing the Soak button which then turns on the soak indicator()• Soak selection : 15 ▶ 30 ▶ 45 ▶ 1:00 ▶ 2:00 ▶ 3:00 ▶ off ▶ 15
<p>4</p>   <p>Rinse times * Child Lock</p> <p>Spin * Air Dry</p>	<p>Press the rinse and Spin buttons to select the number of Rinses and the Spin speed intensity.</p>
<p>5</p> 	<p>Add the suggested detergent indicated by the detergent level indicator and close the Lid.</p>
<p>6</p>  <p>START/PAUSE</p>	<p>Press the START/PAUSE button.</p> <ul style="list-style-type: none">• Water will then be supplied and the Soak wash will begin.
	<p>When the Soak wash program ends, the chime will sound for 10 seconds before the Power turns off automatically.</p>

Intensive Rinse

<p>1</p>  <p>POWER</p>	<p>Press the POWER button to turn power on.</p>
<p>2</p>   <p>Program</p>	<p>Load the clothes and Press the Program button to Select the Washing Program.</p> <ul style="list-style-type: none"> • Intensive Rinse can only be selected with the Cotton Wash and Extra Rinse courses.
<p>3</p>  <p>Rinse times * Child Lock</p>	<p>Press the Rinse button to scroll through the number of Rinses. The Intensive Rinse will be selected on every second press of the Rinse button and indicated by the Intensive indicator. ().</p> 
<p>4</p>  <p>Wash time</p>  <p>Rinse speed * Child Lock</p>  <p>Spin speed * All Dry</p>	<p>Press the Wash and Spin buttons to select the wash time and spin speed intensity.</p>
<p>5</p> 	<p>Add the suggested detergent indicated by the detergent level indicator and close the Lid.</p>
<p>6</p>  <p>START/PAUSE</p>	<p>Press the START/PAUSE button.</p>
	<p>When the wash program ends, the chime will sound for 10 seconds before the Power turns off automatically.</p>







NOTE

- Use Intensive Rinse to remove detergents more effectively.
- Intensive Rinse will be cancelled if the Water Level is changed during operation.

Tub Clean

If scrud is allowed to build-up in the machine it can result in stains on your clothes or an unpleasant smell in your washer.

Scrud is the way build-up that can occur within any washer when the fabric softener comes into contact with Detergent, water quality and temperature will also contribute to the build up of this substance. the Tub clean cycle can help prevent or prolong the build up.

<p>1</p>  <p>POWER</p>	<p>Press the POWER button to turn power on.</p>
<p>2</p>   <p>Program</p>	<p>Press the Program button to Select Tub Clean Program. 『Hot Wash』, 『Cold Wash』 and Water Level of 『1』 will be selected automatically.</p>
<p>3</p>  <p>START/PAUSE</p>	<p>Press the START/PAUSE button. The Tub Clean duration will be displayed on the washers display.</p>
<p>4</p> 	<p>Place the recommend dose of a suitable cleaning agent into the tub and close the Lid. NOTE: Do not add clothes or any items into the tub during this program.</p>
	<p>When the cleaning program ends, the chime will sound for 10 seconds before the Power turns off automatically.</p>

Recommended cleaner :



(1) Powder bleaching agent :

Purchase a suitable product and refer to usage instructions on the product packaging.

(2) Liquid bleaching agent:

Read the manufacturer's instructions carefully.





Do not put laundry for laundry tub course.

- Use oxide bleaching agent (300g). (do not use chlorine bleaching agent.)
- We recommend this program be used at regular intervals. (once a month)
- Remove all lint from the tub before commencing this program.

Automatic Tub Clean reminder.

- If after pressing the Power On button the **t-cl** is displayed, it suggests it is time for Tub Cleaning.
- If you want to skip the Tub Clean, press the Program and option buttons to continue on to the desired cycle. The Tub Clean reminder will reappear after 3 or so washes if it is skipped, and continue to do so until the Tub Clean cycle is carried out.
- After performing tub clean, **t-cl** will disappear until next Tub clean reminder.
- Tub Clean reminder is automatically determined by the washer's usage.
(Generally once after 30 usages)

Air Dry

<p>1</p>  <p>POWER</p>	<p>Press the POWER button to turn power on. Then load up to 2kg of damp or moist clothes into the tub. This function will have no effect on clothes that are soaking wet.</p>
<p>2</p>  <p>Spin * Air Dry</p>	<p>Press the Spin button for 3 seconds to select Air Dry.</p> <ul style="list-style-type: none">• Other functions cannot be selected during Air Dry.• This Function is automatically set to 60 minutes upon selection.• Press the Spin button repeatedly to select the duration (90min. ► 120 min. ► 60 min.)• To deselect Air Dry press power button.
<p>3</p>  <p>START/PAUSE</p>	<p>Press the START/PAUSE button.</p>
	<p>When the Air Dry program ends, the chime will sound for 10 seconds before the Power turns off automatically.</p>



When you select Air Dry for more than 60 minutes







- 1) You can reduce the clothes drying time by minimizing the moisture in the clothes, however, this function will not dry clothes completely but will aid the clothes drying time when they are removed from the tub.
- 2) Always keep the laundry amount to 2kg or less and make sure to spread it out evenly.
- 3) Select 60 minutes for cotton clothing and 120 minutes for synthetic fiber clothing for effective Moisture removal.

Option Washing

When you only need the Wash, Wash/Rinse or Rinse cycles, these can be set manually.

- 1** Press the **POWER** button to turn power on.



2 Wash Only	Rinse Only	Spin Only
<p>Press the Wash button to select the desired wash time.</p>  <p>Wash_{time}</p>	<p>Press the Rinse button to select the desired number of Rinses.</p>  <p>Rinse_{times} * Child Lock</p>	<p>Press the Spin button to select the desired Spin speed intensity.</p>  <p>Spin * Air Dry</p>
<p>Wash and Rinse only</p> <p>Press the Wash button to select the desired wash time.</p>  <p>Wash_{time}</p> <p>Press the Rinse button to select the desired number of Rinses.</p>  <p>Rinse_{times} * Child Lock</p> <p>You can use this option for preventing wrinkles by not allowing the tub to spin after the Rinse.</p>	<p>Rinse and Spin Only</p> <p>Press the Rinse button to select the desired number of Rinses.</p>  <p>Rinse_{times} * Child Lock</p> <p>Press the Spin button to select the desired Spin speed intensity.</p>  <p>Spin * Air Dry</p>	<p>Drain Only</p> <p>Can be used when draining of the remaining tub water in required.</p> <p>Turn on the machine and press the Spin button then press START/PAUSE. The POWER can then be turned off when the remaining water has drained just before the Spin starts.</p>

- 3** Press the **Water Level** button to select the water level according to the amount of laundry. If you do not select a level, it will remain on the middle level default setting. The correct water level is when the clothes are completely submerged in water..



- 4** Add the clothes into the washing tub.

- 5** Press the **START/PAUSE** button.











- 6** Add the detergent and close the lid.

NOTE

- When a Wash, Wash/Rinse or Rinse only option is selected, after the wash is completed the water will not be drained out. If you wish to drain the water, but not engage the spin, then follow the above Drain Only instructions, after the Wash, Wash/Rinse or Rinse only program has ended.
- If you do not specify the water level, then Medium will be automatically selected.

Time Delay (RESERVATION) Wash

<p>1</p>  <p>POWER</p>	<p>Press the POWER button to turn power on.</p>
<p>2</p>    <p>Program</p>	<p>Load the clothes and add the powdered detergent to the soap dispenser and Press the Program button to select the desired Washing Program.</p> <ul style="list-style-type: none">• Do not use liquid detergent in the soap dispenser drawer. Doing so will cause it to dispense immediately and harden in the wash tub.• This program will not work in Delicates and Tub Clean Program.
<p>3</p> 	<p>Press Time Delay (Reservation) button to set the delayed wash ending time.</p> <ul style="list-style-type: none">• If reservation button is pressed, it will turn on the Delay Time indicator and show 3:00. <div data-bbox="336 639 1019 850" style="border: 1px solid gray; padding: 10px;"><p>Eg: It is 1:00 PM and you want to finish the laundry by 7:00 PM</p><ul style="list-style-type: none">• Keep press reservation button to set desired laundry ending time. (1:00 to 7:00 = 6:00 Hours)</div> <ul style="list-style-type: none">• The Time Delay can be set from 3~18 hours by 1 hour intervals up to 3~12hours and 2 hour intervals for 12~18 hours.• A Time Delay of less than 3 hours cannot be selected.
<p>4</p>  <p>START/PAUSE</p>	<p>Close the door and press the START/PAUSE button.</p> <ul style="list-style-type: none">• The Time Delay indicator will flash and the display will show the set delay time.
	<p>The Wash cycle will be completed at the end of the Delayed time indication.</p> <ul style="list-style-type: none">• The end time may vary slightly due to environmental conditions such as water temperature and water inlet pressure.



- To cancel any Time Delay setting, press Time Delay (Reservation) button repeatedly until the reservation is canceled or press the POWER button to turn off the power.

Other Useful Functions

Child Lock Function

If you want to lock all the keys to prevent settings from being changed by a child, you can use the child lock option. For safety reasons, the POWER button will still function whilst the Child Lock mode is activated.

How to Lock

1 Press the **POWER** button.

- Turn Power on.



2 Press the **START/PAUSE** button to start washing.

- After all washing conditions are set according to the manual.



3 Press the **Rinse** button.



- The button lock is set, it will not be released automatically if the cycle is terminated.
- Therefore it will be necessary to turn the POWER back on and cancel the Child Lock function by holding down the "Rinse" button.

How to Unlock

If you want to unlock during wash, press the **Rinse** button again.

NOTE

- "LL" & the remaining time are alternatively shown on the display while the child lock is active during the wash.

Using Tag On Function

- The Tag On function allows you to conveniently use the LG SmartDiagnosis™1 and Cycle Download features to communicate with your appliance from your own smart phone.
- To use the Tag On function:
 1. Download the LG Smart Laundry & DW Global App to your smart phone.
 2. Turn on the NFC (Near Field Communication) function in your smart phone.
- The Tag On function can only be used with most smart phones equipped with the NFC function and based on the Android operating system (OS).

■ Turning on the NFC function of the smart phone



1. Enter the "Settings" menu of the smart phone and select "Share & Connect" or "More ..." under "WIRELESS & NETWORKS".



2. Set the "NFC" and "Direct Android Beam" to ON.

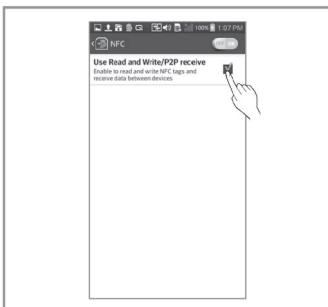

3. Check "Use Read and Write/P2P receive".

NOTE

- Depending on the smart phone manufacturer and Android OS version, the NFC activation process may differ.
- Refer to the manual of your smart phone for details.

Using Tag On Function

■ Turning on the NFC function of the smart phone

▶ Tag On position

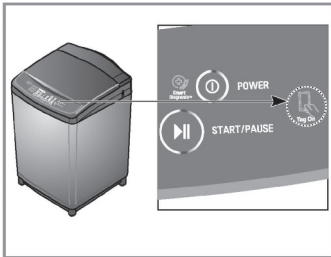

- **Tag On:**
Look for the Tag On icon next to the LED screen on the control panel. This is where you position your smart phone when using the Tag On function with the LG SmartDiagnosis™ and Cycle Download features of the LG Smart Laundry & DW Global App.
- When you use the Tag On function, position your smart phone so that the inbuilt NFC antenna in the back of your smart phone matches the position of the Tag On icon on the appliance. If you do not know the position of your NFC antenna, move your smart phone very slightly in a circular motion until the application verifies the connection.

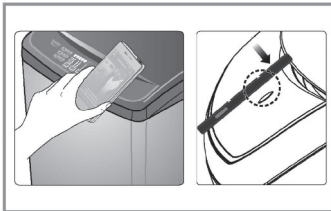

- Because of the characteristics of NFC, if the transmission distance is too far, or if there is a metal sticker or a protective case on the phone, transmission will not be good. In some cases, NFC-equipped phones may be unable to transmit successfully.
- Press **?** in the LG Smart Laundry & DW Global App for a more detailed guide on how to use the Tag On function.

Using Tag On Function

■ Tag On Cycle Download

This function will allow you to choose an additional cycle (available from a list in the LG Smart Laundry & DW Global app) and download the cycle to the "Download Cycle" option on the front of the washing machine control panel.

To use this function, simply select "Tag On Cycle Download" in the LG Smart Laundry & DW Global app (refer to "Before using the Tag On Function" in this manual) and then select your desired cycle from the list, then simply hold your phone next to "Tag On" icon on the front of the washing machine and your desired cycle data will be downloaded to the washing machine "Download Cycle" option on the front control panel.

NOTE

- If the washing machine is currently in the middle of any cycle, you cannot transfer a new cycle to the "Download Cycle" option on the front of the washing machine control panel, an error message "Notice- the appliance is running" will be displayed on the application.
- After the cycle data has been downloaded to the washing machine from the LG Smart Laundry & DW Global app, the "Download Cycle" option will memorise and retain the cycle data, even if the washing machine is switched off then back on at the power point.
- After the cycle data has been downloaded to the washing machine from the LG Smart Laundry & DW Global app, the cycle will not start automatically, you can start the cycle by pressing the "Start/Pause" button on the front of the washing machine control panel.
- As the washing machine is not able to display the additional cycles anywhere on the front control panel, you can check what cycle is currently in use by selecting "Tag On Cycle Download", and tapping the refresh symbol. The app will then prompt you to "Tag on Target Area"

■ Laundry Stats

This function will tell you when the next Tub Clean cycle is needed for your washing machine and also tell you the 3 below points of data from the washing machine:

- The history of the 10 most recently used cycles (in no specific order)
- The most "frequently used cycle"
- The last cycle that was used or that is currently in use

To use this function simply select "Laundry Stats" in the LG Smart Laundry & DW Global app and the above cycle data will be displayed.

NOTE

- If washing machine is turned off from the power point and then back on, the washing machine will still memorise and retain all 3 above points of cycle data.
- If the unit is currently in the middle of any cycle, you can still use the "Laundry Stats" function of the LG Smart Laundry & DW Global app.

■ Tag On Cycle Set

This function will explain in more detail, the recommended applications for some certain cycles that are available on the front of the washing machine control panel. (excluding "Download Cycle").

To use this function simply select the "Tag On Cycle Set" on your LG Smart Laundry & DW Global app, then select your applicable cycle, then simply hold your phone up to "Tag On" icon of the front of the washing machine and the desired cycle will automatically start.

NOTE

- If the unit is currently in the middle of a cycle, you cannot set a "Tag On Cycle Set, an error message "Notice- the appliance is running" will be displayed on the application.

Placing and Leveling

Please ensure any foam transit restraint has been removed from the machines packaging before.

1 Place the machine on a flat and firm surface which allows proper clearance.

We suggest a minimum clearance of 2 cm to the right and left sides of the machine for ease of installation.

At the rear, a minimum clearance of 10 cm is suggested.

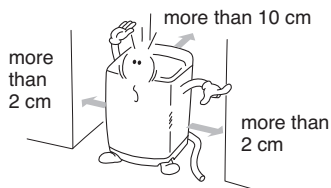

NOTE

If the washer is installed on an uneven, tilted, or weak timber floor causing excessive vibration, a spin failure or “UE” error can occur.

It must be placed on a firm and level floor to prevent spin failure.

2 Check that the machine is level

Open the lid and look from above to see if it is same as shown.

Top view of the machine

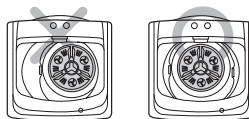

3 Leveling the machine

Lift the front of the washing machine and twist the appropriate Adjustable Leg until the surface bubble is (some models only) located in the center.



Adjustable legs

How to use the rubber adjusting plates

- Use the adjusting plates to level the washer when the adjustable legs cannot cover the gap.

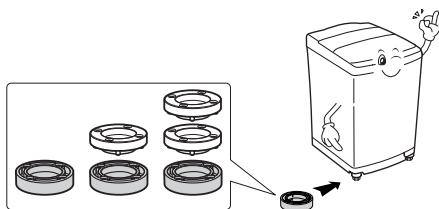

Caution

If an extension cord or power board is used, ensure it is positioned so that it is not exposed to water or moisture. This machine should be connected to a 230~240v town mains power outlet.

Connecting Water Supply Hose

Before connecting the Water Supply Hose to the water tap, check the hose type and then choose the correct instruction here under.

Note that the Water Supply Hose supplied may vary from country to country, Make sure to connect the blue inlet hose to the COLD water tap, and the orange inlet hose to the HOT water tap.

Connecting Water Supply Hose to water tap

Normal Type (Normal tap without thread & screw type inlet hose.)

1 Untighten the screw

Untighten the screw of the connector so that the tap can be placed in the middle.

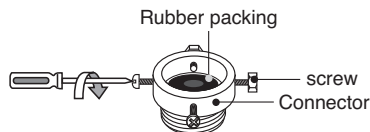

2 Fixing the connector to the tap

Push the upper connector up till the rubber packing is in tight contact with the tap. Then tighten the 4 screws.

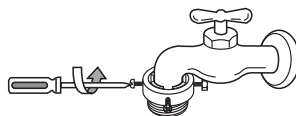

3 Attach the water supply hose securely to the connector

Push the water supply hose vertically upwards so that the rubber seal within the hose can adhere completely to the tap.

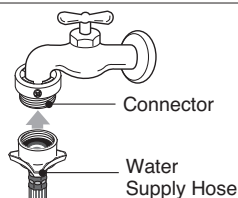

4 Fixing the connector to the water supply hose

Attach the water supply hose to the connector and then tighten it by screwing it to the right.

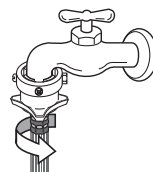

5 Check the connection of water supply hose and the connector

After connecting the hose, open the tap to check for any water leakage. If the water leaks, close the tap and start again from step 1

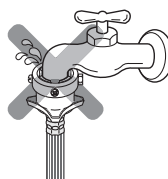

NOTE

The washing machine is to be connected to the water mains using new hose-sets and old hose-sets should not be reused.

Connecting Water Supply Hose

Normal Type (Normal tap without thread & one touch type inlet hose.)

1 Separate Middle connector from Water Supply Hose

Separate Middle connector from the Water Supply Hose by pulling the Pressing Rod and the Pressing Handle that is attached to the Water Supply Hose.

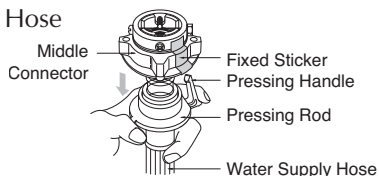

2 Loosen the fixed nuts to connect the connector to the tap

Untighten the screw of the connector so that the tap can be placed in the middle.

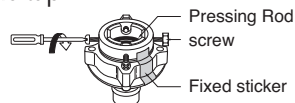

NOTE

In case tap is too large.
If the tap diameter is too large or is square, untighten the 4 screws and remove the guide plate. Then follow step 1.

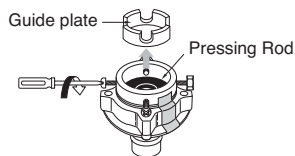

3 Fixing Connectors to the Tap

Push the upper connector up till the rubber packing is in tight contact with the tap. Then tighten the 4 screws.

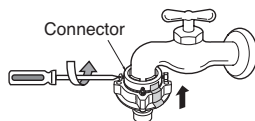

4 Fixing Upper Connector and Middle Connector

Remove the fixed sticker in between the Upper and Middle Connectors. Tighten the connectors by holding one connector and twist middle connector to the right.

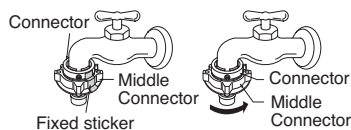

5 Connecting Middle Connector and Water Supply Hose

Press down the pressing rod of the Water Supply Hose which was separated from middle connector (refer to Step 1) and then join it to the middle connector.

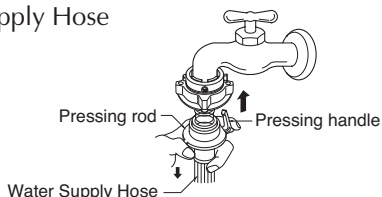

6 Check for water leakage

After connecting the hose, open the tap to check for any water leakage.

If the connection leaks, close the tap and start again from step 1.

If you skip step 1, water leakage may occur.



Screw Type

1 Attach the water supply hose to the tap.

Push the water supply hose up so that the rubber washer within the hose is properly seated to the tap.

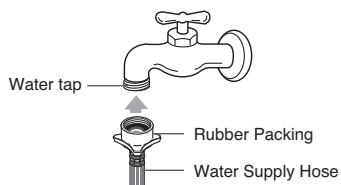

2 Connect the water supply hose to the tap.

Connect the water supply hose to the tap and then tighten it by screwing it to the right. Securely Hand tighten only. Do not use any mechanical device to tighten the hose connector.

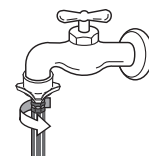

3 Check for water leakage.

After connecting the hose to both the tap and the machine, open the tap to check for any water leakage.

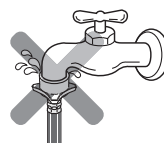

Connecting Water Supply Hose to the machine

- Connect the water supply hose to the inlet valve of the washing machine, and then turn the hose connector to the right until secure. Do not use any mechanical device to tighten. Hand tighten only.
- Make sure there is a rubber washer in both connectors before connecting

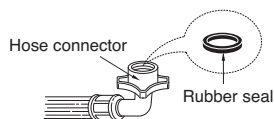
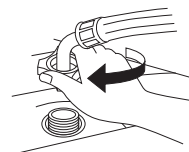

Connecting the Drain Hose

Before connecting the Drain Hose, check your Drain Hose model and choose the correct instructions.

Pump Model

- 1 Fit the end of the drain hose to the outlet of the drain pump and secure the clamp.

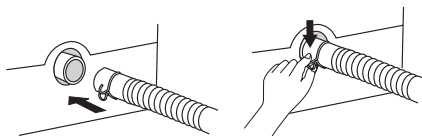

- 2 Put the other end of the drain hose over the standpipe or wash tub.

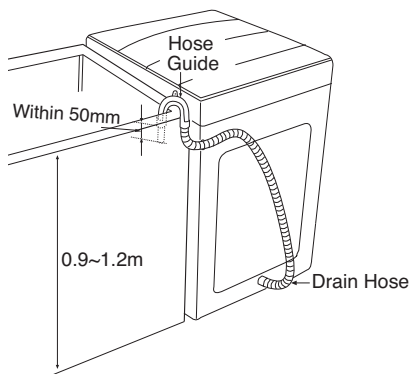

NOTE

- To prevent siphoning, the drain hose should not extend more than 50 mm from the end of the hose guide.
- The discharge height should be approximately 0.9 ~ 1.2 m from the floor.

Cleaning and Maintenance

Cold water washing

- If you always use COLD water, we recommend that a WARM or HOT wash be used at a regular intervals e.g. every 5th wash should be at least a WARM one.

When you have finished

- Turn off taps to prevent the chance of flooding should a hose burst.
- Always unplug the power cord after use.
Turning the washer off from the POWER button does not disconnect the main power.

When water supply into the tub is not clean or the inlet valve filter is clogged with particles (such as sand), clean the filter in the inlet valve occasionally.

(The image of the power cord and water tap may vary according to the country)

To Clean the Filter in the Inlet Valve

- 1** Close the taps. Turn on the washer and press START/PAUSE. the washer will attempt to commence washing and release the water in the inlet valves. When there is no more water, turn the power off from the mains outlet switch.



- 2** Turn off the power before pulling out the cord.



- 3** After removing the inlet water supply hose pull out the filter. Then use a brush to clean the filter.



- 4** Refit the filter after cleaning it and reconnect the inlet hose as per the installation instructions.

NOTE

- before reconnecting the inlet hose, turn the tap on for 30 seconds, with the hoses in the sink so that any impurities in the water line can be flushed out.

To Clean the Pump casing (for pump model)

- 1** Remove the power cord from the power outlet and place a towel on the floor under the drain pump cap. Excess water will flow out.

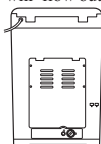

- 2** Turn the cap counter-clockwise and pull it out while taking note the configuration.

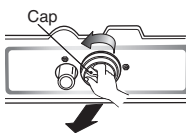

- 3** Remove any foreign objects and fluff inside pump casing and from the filter.

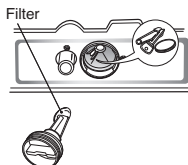

- 4** Refit the cap. Insert the filter along the guide ribs inside the pump casing. Filter must face the guide ribs inside pump casing and securely turn the cap clockwise.

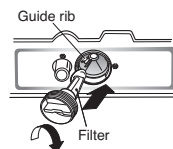

NOTE

- Check for water leaks after refitting by adding a bucket of water into the tub. (The Rubber O ring must remain in the cap)

Cleaning and Maintenance

When there is a fear of freezing

- Close the water taps and remove the Water Supply Hose.
- Remove the water which remains in the water supply.
- Lower the drain hose and drain the water in the bowl and the drain hose by spinning.

If frozen

- Remove the water supply hose, and immerse it in HOT water at approx.. 40°C.
- Pour approx.. 2 liters of HOT water at approx.. 40°C, into the bowl and let it stand for 10 minutes.
- Connect the water supply hose to the water tap and confirm that the washing machine performs the supply and drainage of water.

Inner Wash tub

Leave the lid open after washing to allow moisture to evaporate. If you want to clean the inner-tub use a clean soft cloth dampened with liquid Detergent, then rinse. (Do not use harsh or gritty cleaners.)

Inlet Hoses

Hoses connecting washer to the tap should be replaced every 5 years.

Exterior

Immediately wipe off any spills. Wipe with damp cloth. Try not to hit surface with sharp objects.

Long Vacations

Be sure that the water supply is shut off at the taps. Drain all water from hoses if weather will be below freezing.

Cleaning the Inside of your Washer

If you use fabric softener or do regular COLD water washing, it is very important that you occasionally clean the inside of your washer.

- Fill your washer with HOT water.
- Add about two cups of a powdered Detergent that contains phosphate.
- Let it operate for several minutes.
- Stop the washer, open the lid and leave it to soak overnight.
- After soaking, drain the washer and run it through a normal cycle.

Or use TUB CLEAN PROGRAM periodically.

Do not wash clothes during this procedure.

Products that might damage your washing machine

- Concentrated bleaches and nappy sanitizer will cause damage to the paintwork and components of your washer.
- Hydrocarbon solvents i.e. petrol, paint thinners and lacquer thinners, etc. can dissolve plastic and blister paint (Be careful when washing garments stained with these solvents as they are flammable DO NOT put them in washer or dryer.)
- Some pretreatment sprays or liquids can damage your washer's control panel when applied next to the washer.
- Use of dyes in your washer may cause staining of the plastic components. The dye will not damage the machine but we suggest you thoroughly clean your washer afterwards. We do not recommend the use of dye strippers in your washer.
- Do not use your washer lid as a work surface.

Soft Safety Door (where fitted)

- Using tempered glass, the inside of the washer can be seen safely during a wash.
- To prevent sudden close of door, it has a dampened hinge so the door closes softly.
- Door is heavy. Be careful not to place hands in the door closing area when operating. It might cause injury or damage to the product.

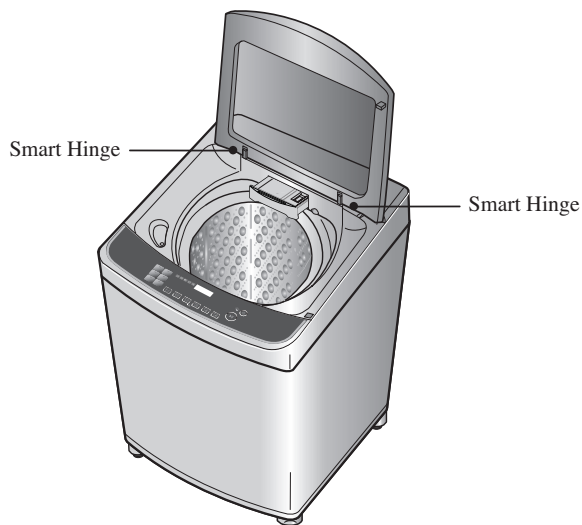

- For customer safety, the door will be locked automatically during operation. When the door is locked, the 'door lock' indicator will be on. If more clothes need to be added, press the START/PAUSE to unlock.
- Press START/PAUSE Button again to resume operation. The machine will turn off automatically if it is interrupted during the wash for any reason and is not resumed by pressing the START/PAUSE button again within 4 minutes.

Common washing problems









Many washing problems involve poor soil & stain removal, Lint and scum residue, and fabric damage. For satisfactory washing results, follow these instructions.

WASH PROBLEM

Problems	Possible Causes	Solutions & Preventive Measures
Poor soil removal	<ul style="list-style-type: none"> • Not enough Detergent • Wash Water Temperature too cold. • Overloading the washer • Incorrect wash cycle • Incorrect sorting • Not pretreating stains 	<ul style="list-style-type: none"> • Use correct amount of Detergent for load size, amount of soil and water Hardness. • Different Water Temperature may be required according to soil type. • Reduce load size and manually increase the water level. • Wash with DUVET or SOAK & DUVET wash cycle for heavy soiled items. • Separate heavily soiled items from lightly soiled ones. • Pretreat stains and heavy soil according to directions shown on page 9.
Blue Stains	<ul style="list-style-type: none"> • Undiluted fabric softener dispensed directly onto fabric 	<ul style="list-style-type: none"> • Rub the stain with bar soap. Wash. • Do not overfill fabric softener dispenser and do not pour liquid fabric softener directly onto fabric. <p>See page 12 for more instructions.</p>
Black or gray marks on clothes	<ul style="list-style-type: none"> • A buildup caused by the interaction of fabric softener and Detergent can flake off and mark clothes • Not enough Detergent 	<ul style="list-style-type: none"> • Keep the recommendations against Scrud(waxy buildup). (refer to scrud page12.) • Use correct amount of Detergent for load size, amount of soil and water Hardness.
Yellow or brown rust stains	<ul style="list-style-type: none"> • Iron or manganese in water supply, water pipes, or water heater 	<ul style="list-style-type: none"> • To restore discolored load of whites, use rust remover safe for fabric. • Install nonprecipitating water softener or an iron filter in your water supply system for an ongoing problem. • Before washing, run water for a few minutes to clear lines.
Lint	<ul style="list-style-type: none"> • Incorrect sorting • Tissues left in pocket • Overloading the washer 	<ul style="list-style-type: none"> • Wash lint givers eg towels, flannelette sheets, separately from lint collectors eg synthetic fabrics and remove tissues in pockets before wash. See page 9 for sorting and caring before loading. • Do not overload the washer . Manually increase the water level.
Residue or Detergent	<ul style="list-style-type: none"> • Overloading the washer • Undissolved Detergent • Using too much Detergent 	<ul style="list-style-type: none"> • Do not overload the washer. • Some Detergents need to be pre-dissolved, check the Detergent instructions. Try pre-dissolving the Detergent. • Increase Water Temperature using HOT water safe for fabric. • Use proper amount of Detergent.
Holes, tears, or snags	<ul style="list-style-type: none"> • Incorrect use of chlorine bleach. • Unfastened zippers, hooks, buckles • Ribs, tears and broken threads • Overloading the washer • Degradation of fabric 	<ul style="list-style-type: none"> • Never pour chlorine bleach directly on fabric. See page 11 for adding liquid bleach. • Fasten zippers, hooks, and buckles. • Remove objects in pockets. See page 9 for caring before loading. • Do not overload the washer.

Troubleshooting

Before calling for service, check the problem against the list below.

Symptom	Error Message	What to Check
Water Supply Failure		<ul style="list-style-type: none"> • Is the water tap shut off? • Is the water supply cut off ? • Is the drain hose installed too low? • Is the water pressure too high or too low, or is the filter of the inlet valve clogged with impurities? • Is the Hot hose connected to cold? • Is the Cold hose connected to hot?
Drainage Failure		<ul style="list-style-type: none"> • Is the drain hose positioned correctly? • Is the drain hose bent or placed too high? • Is the internal part of the hose or drain pump (only pump model) clogged with impurities? • Check if electric power has gone off.
Spin Failure		<ul style="list-style-type: none"> • Is the laundry evenly balanced? • Is the washing machine placed on a flat and level surface? <p>Press the "Start/Pause" button to release the HE, now distribute the laundry evenly and then press the "Start/Pause" button again to resume the cycle.</p>
Door(Lid) Open		<ul style="list-style-type: none"> • Is the lid closed?
Door(Lid) Lock malfunction		<ul style="list-style-type: none"> • Is the lid closed? • Make sure that the lid is closed properly and press the START/PAUSE button. The washer will not operate unless the lid is locked. • Make sure that nothing is caught under the lid, including shipping material or clothing.
Child Lock		<ul style="list-style-type: none"> • CL(Child Lock) does not indicate a malfunction. • This function prevents accidental cycle changes or interruptions during the wash cycle. The Child Lock function will remain engaged even after the cycle has finished. Press the Rinse button for 3 seconds to unlock. Take care not to set up inadvertently during use.
Foreign objects		<ul style="list-style-type: none"> • Are there foreign objects, Such as coins, pins, etc., caught between the wash pulsator and the inner tub ? • Turn off the washer and then press the Power button. Press the spin speed button without selecting a cycle to drain and spin the load. When the spin is complete, remove the clothes and then find and remove any objects caught in the wash pulsator.
Tub Clean Reminder		<ul style="list-style-type: none"> • Empty the tub, insert bleach into the detergent dispenser and select the Tub Clean cycle. • If you want to skip the Tub Clean, press the program and option buttons to select desired cycle. In this case, you will see the message again after a few more wash cycles. Once the Tub Clean cycle is performed, tcl will disappear until the next reminder to clean the tub.
		<ul style="list-style-type: none"> • Please call your nearest LG Electronics service center for help.

SmartDiagnosis™

- 1 Close the washer door, and press the **POWER** button to turn on the machine. (Smart Diagnosis will not operate if the Washer has a power problem.)



- Do not press any buttons other than the ones indicated below.

- 2 Place the phone to the **SmartDiagnosis™** display icon.



- Make sure that the phone's mic faces the SmartDiagnosis™ display



- 3 Hold down the **Cold Wash** button to activate smart diagnosis.



- Place the phone near the SmartDiagnosis™ display, and hold down the Cold Wash button until tak tat tak sounds are heard.



- 4 Hold the phone while data is transmitted.

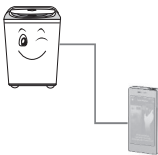

- Keep the phone placed to the SmartDiagnosis™ display while data for smart diagnosis is being transmitted. The time remaining for data transmission will be displayed on the washer display.
- Transmission sound may be irritating. For proper diagnosis, do not remove the phone.

- 5 After the data transmission is completed, listen to the diagnosis result from the consultant.



- When data transmission is completed, the power is automatically turned off with "End" displayed for a few seconds.

NOTE

Smart Diagnosis is a troubleshooting feature designed to assist, not replace, the traditional method of troubleshooting through service calls. The effectiveness of this feature depends upon various factors, including, but not limited to, the reception of the cellular phone being used for transmission, any external noise that may be present during the transmission, and the acoustics of the room where the machine is located. Accordingly, LG does not guarantee that Smart Diagnosis can accurately troubleshoot any given issue.

Specification

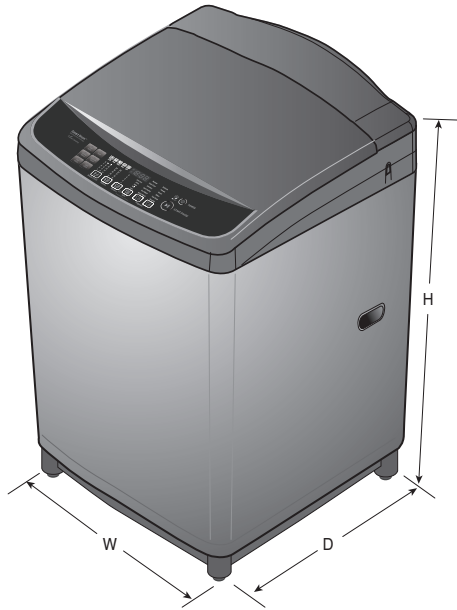

Model	WTG9532VH	WTG9532WH	WTG8532WH
Power supply	230V~, 50 Hz		
Wash capacity	9.5 kg		8.5 kg
Rated input	1650 W		
Weight	50 kg		
Size	632(W) × 670(D) × 1020(H) mm		
Water tap pressure	100 kPa ~ 600 kPa		
P No. (Degree of Protection)	IPX4		
Country of origin	MADE IN KOREA		

※ In our continuing effort to improve the quality of our appliances, it may be necessary to make changes to the appliance without revising this manual.

Memo

Memo

Memo

Memo

Memo

Memo

