

USER MANUAL



CONTENTS

1. SAFETY INFORMATION.....	3
2. CONDITIONS OF USE.....	5
3. SAFETY INSTRUCTIONS.....	5
4. INSTALLATION.....	7
5. PRODUCT DESCRIPTION.....	8
6. DAILY USE.....	10
7. ADDITIONAL FUNCTIONS.....	14
8. CARE AND CLEANING.....	17
9. HINTS AND TIPS.....	17
10. TROUBLESHOOTING.....	20
11. TECHNICAL DATA.....	22
12. ENERGY EFFICIENCY.....	22
13. WARRANTY.....	23
14. ENVIRONMENTAL CONCERNS.....	25

IMPORTANT INFORMATION THAT MAY IMPACT YOUR MANUFACTURER'S WARRANTY

Adherence to the directions for use in this manual is extremely important for health and safety. Failure to strictly adhere to the requirements in this manual may result in personal injury, property damage and affect your ability to make a claim under the AEG manufacturer's warranty provided with your product. Products must be used, installed and operated in accordance with this manual. You may not be able to claim on the AEG manufacturer's warranty in the event that your product fault is due to failure to adhere to this manual.

FOR PERFECT RESULTS

Thank you for choosing this AEG product. We have created it to give you impeccable performance for many years, with innovative technologies that help make life simpler features you might not find on ordinary appliances. Please spend a few minutes reading to get the very best from it.

Visit our website for:



Get usage advice, brochures, trouble shooter, service information:
www.aeg.com



Register your product for better service:
www.registeraeg.com

CUSTOMER CARE AND SERVICE

Always use original spare parts.

When contacting our Authorised Service Centre, ensure that you have the following data available: Model, PNC, Serial Number.

The information can be found on the rating plate.

 Warning / Caution-Safety information

 General information and tips



Subject to change without notice.

1. SAFETY INFORMATION

Before the installation and use of the appliance, carefully read the supplied instructions. The manufacturer is not responsible for any injuries or damage that are the result of incorrect installation or usage. Always keep the instructions in a safe and accessible location for future reference.

1.1 Children and vulnerable people safety

- This appliance can be used by children aged from 8 years and above and persons with reduced physical, sensory or mental capabilities or lack of experience and knowledge if they have been given supervision or instruction concerning the use of the appliance in a safe way and understand the hazards involved. Children of less than 8 years of age and persons with very extensive and complex disabilities shall be kept away from the appliance unless continuously supervised.
- Children should be supervised to ensure that they do not play with the appliance.
- Keep all packaging away from children and dispose of it appropriately.
- **WARNING:** Keep children and pets away from the appliance when it operates or when it cools down. Accessible parts become hot during use.
- If the appliance has a child safety device, it should be activated.
- Children shall not carry out cleaning and user maintenance of the appliance without supervision.

1.2 General Safety

- **WARNING:** The appliance and its accessible parts become hot during use. Care should be taken to avoid touching heating elements.
- **WARNING:** Unattended cooking on a hob with fat or oil can be dangerous and may result in fire.
- **NEVER** try to extinguish a fire with water, but switch off the appliance and then cover flame e.g. with a lid or a fire blanket.
- **CAUTION:** The appliance must not be supplied through an external switching device, such as a timer, or connected to a circuit that is regularly switched on and off by a utility.
- **CAUTION:** The cooking process has to be supervised. A short term cooking process has to be supervised continuously.
- **WARNING:** Danger of fire: Do not store items on the cooking surfaces.
- Metallic objects such as knives, forks, spoons and lids should not be placed on the hob surface since they can get hot.
- Do not use the appliance before installing it in the built-in structure.
- Do not use a steam cleaner to clean the appliance.
- After use, switch off the hob element by its control and do not rely on the pan detector.
- If the glass ceramic surface / glass surface is cracked, switch off the appliance and unplug it from the mains. In case the appliance is connected to the mains directly using junction box, remove the fuse to disconnect the appliance from power supply. In either case contact the Authorised Service Centre.
- If the supply cord is damaged, it must be replaced by the manufacturer, an authorized Service or similarly qualified persons in order to avoid a hazard.
- **WARNING:** Use only hob guards designed by the manufacturer of the cooking appliance or indicated by

the manufacturer of the appliance in the instructions for use as suitable or hob guards incorporated in the appliance. The use of inappropriate guards can cause accidents.

2. CONDITIONS OF USE

This appliance is intended to be used in household and similar applications such as:

- Farm houses

- By clients in serviced apartments, holiday apartments and other residential type environments.

3. SAFETY INSTRUCTIONS

3.1 Installation



WARNING!

Only a qualified person must install this appliance.



WARNING!

Risk of injury or damage to the appliance.

- Remove all the packaging.
- Do not install or use a damaged appliance.
- Follow the installation instructions supplied with the appliance.
- Keep the minimum distance from other appliances and units.
- Always take care when moving the appliance as it is heavy. Always use safety gloves and enclosed footwear.
- Seal the cut surfaces with a sealant to prevent moisture from causing swelling.
- Protect the bottom of the appliance from steam and moisture.
- Do not install the appliance next to a door or under a window. This prevents hot cookware from falling from the appliance when the door or the window is opened.
- Each appliance has cooling fans on the bottom.
- If the appliance is installed above a drawer:
 - Do not store any small pieces or sheets of paper that could be pulled in, as they can damage the cooling fans or impair the cooling system.

- Keep a distance of minimum 2 cm between the bottom of the appliance and parts stored in the drawer.
- Remove any separator panels installed in the cabinet below the appliance.

3.2 Electrical Connection



WARNING!

Risk of fire and electric shock.

- All electrical connections should be made by a qualified electrician.
- The appliance must be earthed.
- Before carrying out any operation make sure that the appliance is disconnected from the power supply.
- Make sure that the parameters on the rating plate are compatible with the electrical ratings of the mains power supply.
- Make sure the appliance is installed correctly. Loose and incorrect electricity mains cable or plug (if applicable) can make the terminal become too hot.
- Use the correct electricity mains cable.
- Do not let the electricity mains cable tangle.
- Make sure that a shock protection is installed.
- Use the strain relief clamp on the cable.
- Make sure the mains cable or plug (if applicable) does not touch the hot

appliance or hot cookware, when you connect the appliance to the near sockets.

- Do not use multi-plug adapters and extension cables.
 - Make sure not to cause damage to the mains plug (if applicable) or to the mains cable. Contact our Authorised Service Centre or an electrician to change a damaged mains cable.
 - The shock protection of live and insulated parts must be fastened in such a way that it cannot be removed without tools.
 - Connect the mains plug to the mains socket only at the end of the installation. Make sure that there is access to the mains plug after the installation.
 - If the mains socket is loose, do not connect the mains plug.
 - Do not pull the mains cable to disconnect the appliance. Always pull the mains plug.
 - Use only correct isolation devices: line protecting cut-outs, fuses (screw type fuses removed from the holder), earth leakage trips and contactors.
 - The electrical installation must have an isolation device which lets you disconnect the appliance from the mains at all poles. The isolation device must have a contact opening width of minimum 3 mm.
- Do not put cutlery or saucepan lids on the cooking zones. They can become hot.
 - Do not operate the appliance with wet hands or when it has contact with water.
 - Do not use the appliance as a work surface or as a storage surface.
 - If the surface of the appliance is cracked, disconnect immediately the appliance from the power supply. This to prevent an electrical shock.
 - Users with a pacemaker must keep a distance of minimum 30 cm from the induction cooking zones when the appliance is in operation.
 - When you place food into hot oil, it may splash.



WARNING!

Risk of fire and explosion

- Fats and oil when heated can release flammable vapours. Keep flames or heated objects away from fats and oils when you cook with them.
- The vapours that very hot oil releases can cause spontaneous combustion.
- Used oil, that can contain food remnants, can cause fire at a lower temperature than oil used for the first time.
- Do not put flammable products or items that are wet with flammable products in, near or on the appliance.

3.3 Use



WARNING!

Risk of injury, burns and electric shock.

- Remove all the packaging, labelling and protective film (if applicable) before first use.
 - This appliance is for household (indoors) use only.
 - Do not change the specification of this appliance.
 - Make sure that the ventilation openings are not blocked.
 - Do not let the appliance stay unattended during operation.
 - Set the cooking zone to "off" after each use.
 - Do not rely on the pan detector.
- Do not keep hot cookware on the control panel.
 - Do not put a hot pan cover on the glass surface of the hob.
 - Do not let cookware boil dry.
 - Be careful not to let objects or cookware fall on the appliance. The surface can be damaged.
 - Do not activate the cooking zones with empty cookware or without cookware.
 - Do not put aluminium foil on the appliance.
 - Cookware made of cast iron, aluminium or with a damaged bottom can cause scratches on the glass / glass ceramic. Always lift these

objects up when you have to move them on the cooking surface.

- This appliance is for cooking purposes only. It must not be used for other purposes, for example room heating.

3.4 Care and cleaning

- Clean the appliance regularly to prevent the deterioration of the surface material.
- Switch off the appliance and let it cool down before cleaning.
- Do not use water spray and steam to clean the appliance.
- Clean the appliance with a moist soft cloth. Use only neutral detergents. Do not use abrasive products, abrasive cleaning pads, solvents or metal objects.

3.5 Service

- To repair the appliance contact the Authorised Service Centre. Use original spare parts only.

- Concerning the lamp(s) inside this product and spare part lamps sold separately: These lamps are intended to withstand extreme physical conditions in household appliances, such as temperature, vibration, humidity, or are intended to signal information about the operational status of the appliance. They are not intended to be used in other applications and are not suitable for household room illumination.

3.6 Disposal



WARNING!

Risk of injury or suffocation.

- Contact your municipal authority for information on how to dispose of the appliance.
- Disconnect the appliance from the mains supply.
- Cut off the mains electrical cable close to the appliance and dispose of it.

4. INSTALLATION



WARNING!

Refer to Safety chapters.

4.1 Before the installation

Before you install the hob, write down the information below from the rating plate. The rating plate is on the bottom of the hob.

Serial number

4.2 Built-in hobs

Only use the built-in hobs after you assemble the hob into correct built-in units and work surfaces that align to the standards.

4.3 Connection cable

- The hob is supplied with a connection cable.
- To replace the damaged mains cable, use the cable type: H05V2V2-F which withstands a temperature of 90 °C or higher. Contact an Authorised Service

Centre. The connection cable may only be replaced by a qualified electrician.

4.4 Assembly

If you install the hob under a hood, please see the installation instructions of the hood for the minimum distance between the appliances.

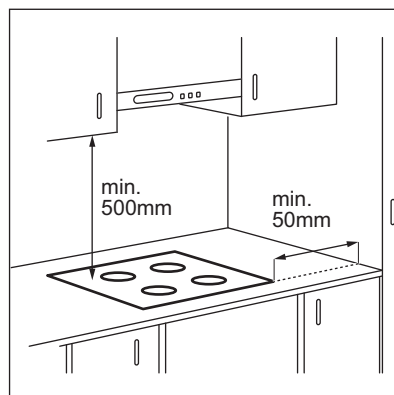

If the appliance is installed above a drawer, the hob ventilation can warm up the items stored in the drawer during the cooking process.

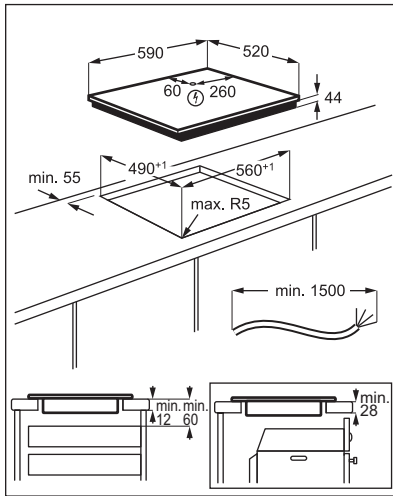

Find the video tutorial "How to install your AEG Induction Hob - Worktop installation" by typing out the full name indicated in the graphic below.

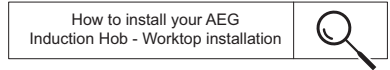

5. PRODUCT DESCRIPTION

5.1 Cooking surface layout

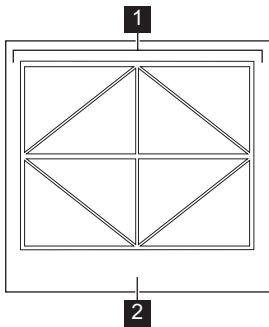

- 1 Induction cooking surface
- 2 Control panel

5.2 Control panel layout

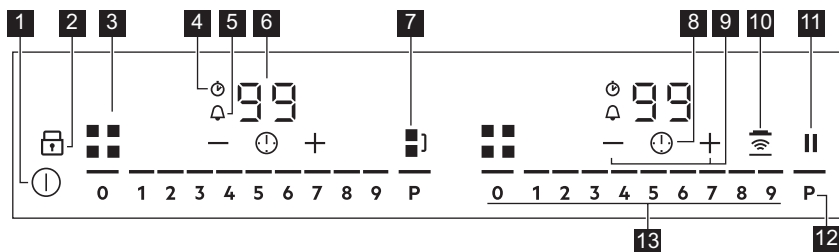

Use the sensor fields to operate the appliance. The displays, indicators and sounds tell which functions operate.

Sensor field	Comment
1	To activate and deactivate the hob.
2	To activate and deactivate Lock or Child Safety Device.
3	To show the active zone.
4	CountUp Timer indicator.
5	Count Down Timer indicator.
6	- Timer display: 00 - 99 minutes.
7	To activate and deactivate Bridge and to switch between the modes.
8	To select Timer functions.
9	To increase and decrease the time.
10	To activate and deactivate Hob²Hood.
11	To activate and deactivate Pause.
12	To activate PowerBoost.
13	- To set a heat setting: 0 - 9.

5.3 OptiHeat Control (3 step Residual heat indicator)



WARNING!

- As long as the indicator is on, there is a risk of burns from residual heat.

The induction cooking zones produce the heat necessary for the cooking process directly in the bottom of the cookware. The glass ceramic is heated by the heat of the cookware.

The indicators appear when a cooking zone is hot. They show the level of the residual heat for the cooking zones you are currently using.

The indicator may also appear:

- for the neighbouring cooking zones even if you are not using them,
- when hot cookware is placed on cold cooking zone,

- when the hob is deactivated but the cooking zone is still hot.

The indicator disappears when the cooking zone has cooled down.

6. DAILY USE



WARNING!

Refer to Safety chapters.

6.1 Activating and deactivating

Press and hold  to activate or deactivate the hob.

Control bars come on after you activate the hob and go off after you deactivate the hob. When the hob is deactivated you can see only .

When you activate the hob and place the cookware in the correct position, the hob recognizes it and the appropriate control panel lights up. The red cooking zone indicator appears above the control bar and indicates the position of the pot.

6.2 Automatic Switch Off

The function deactivates the hob automatically if:

- you do not place any cookware on the hob for 50 seconds,
- you do not set the heat setting for 50 seconds after you place the cookware,
- you spill something or put something on the control panel for more than 10 seconds (a pan, a cloth). When you hear the acoustic signal, the hob deactivates. Remove the object or clean the control panel.
- the hob gets too hot (e.g. when a saucepan boils dry). Let the cooking zone cool down before you use the hob again.
- you do not deactivate a cooking zone or change the heat setting. After some time, the hob deactivates.

The relation between the heat setting and the time after which the hob deactivates:

Heat setting	The hob deactivates after
1 - 2	6 hours
3 - 4	5 hours
5	4 hours
6 - 9	1.5 hours

6.3 Heat setting

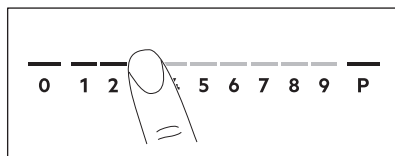

Press the desired heat setting on the control bar. You can also move your finger along the control bar to set or change the heat setting for a cooking zone.

To deactivate a cooking zone, press 0.

6.4 Using the hob

The induction cooking surface consists of 8 single triangular zones in total. The triangular zones may be activated separately or can be combined in pairs to create 4 standard cooking zones. The pairs of triangular zones can be further combined together in various ways.

Each pair of triangles is controlled by the appropriate control bar. Each square on the control panel represents one standard cooking zone on the induction cooking surface.

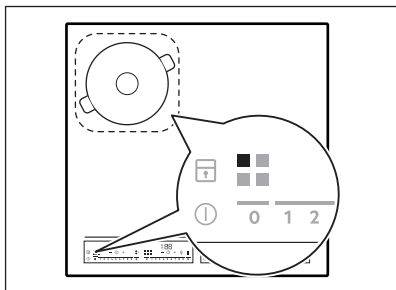

- i** One pair of triangles works as a standard cooking zone.

Cookware

You may use various sizes of cookware: small, medium, large. To learn how the hob determines the cooking mode based on the cookware refer to "Induction cooking surface" below. For more information on cookware, refer to "Hints and tips".

6.5 Induction cooking surface

The hob automatically determines the mode applicable to the size and the shape of the cookware.

Place the cookware centrally on the selected area. The cookware should cover the selected area as much as possible.

- Smaller cookware with the bottom diameter between 100 mm and 160 mm should be placed centrally on a single triangle.

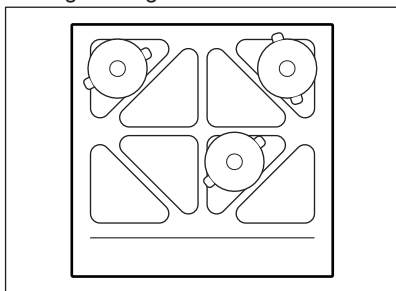

- Medium-sized cookware with the bottom diameter between 160 mm and 210 mm should be placed on a pair of triangles.

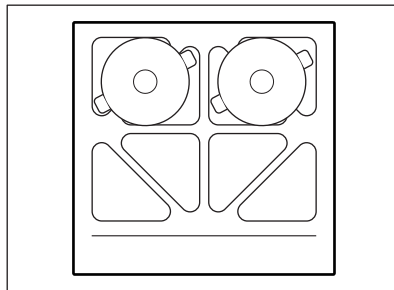

- Cookware with the bottom diameter between 240 mm and 350 mm should be placed on four triangles.

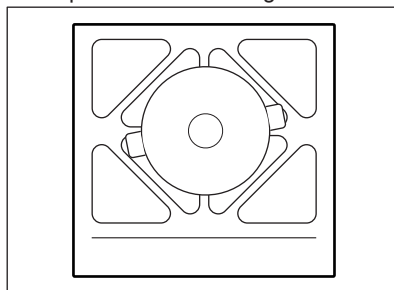

- Oval-shaped cookware (e.g. roasting tins) should be placed on vertical or horizontal Bridge combinations.

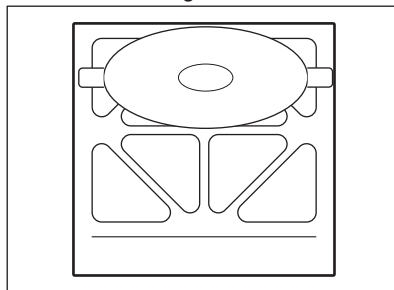

- i** The cookware must cover 3 or 4 triangles.

6.6 Using the control panel and zone indicators

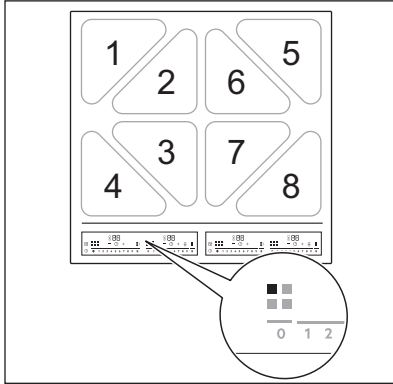

Two single triangles combined create a standard cooking zone and are indicated by the A B C D indicators.

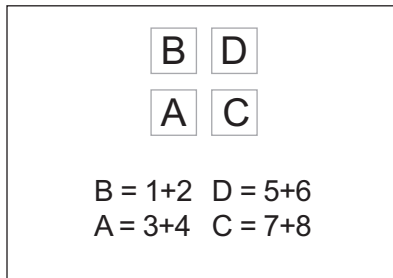

Zone indicators indicate which standard cooking zone is controlled by the appropriate control bar. The hob has 4 control bars.

Cookware positions and zone indicators

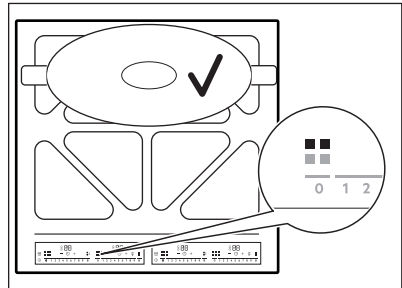
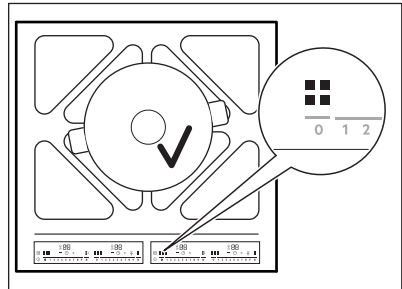
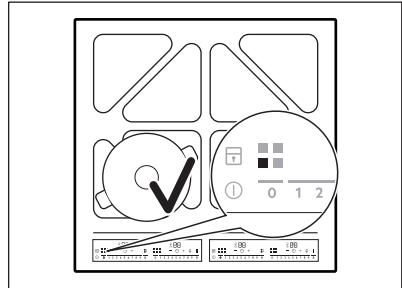
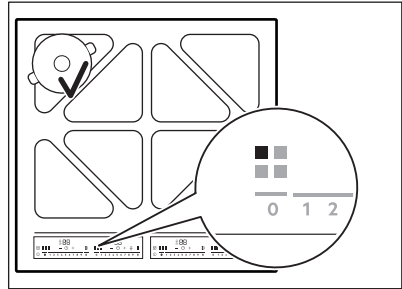

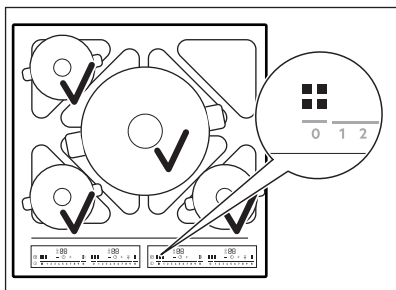
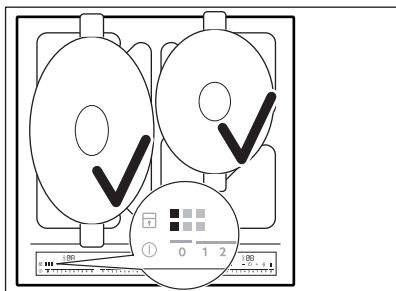

For the combination indicated above, there are four active control bars. The left front pot is indicated by A indicator visible on the first control bar. The left rear pot is indicated by B indicator on the second control bar. The middle pot is indicated by indicators A B C D visible on the third control bar. The right front pot is indicated by C indicator visible on the fourth bar.

- i** It is not possible to use more than 4 pots in this combination.

6.7 Incorrect cookware positions

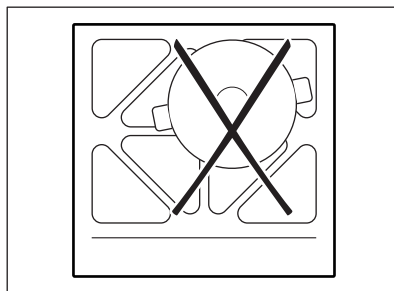
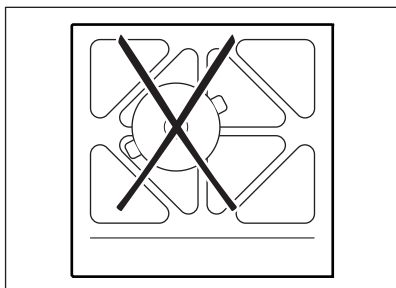

6.8 Bridge

If you place cookware on two or more standard cooking zones and the heat setting level is set to 0, **P** appears.

If the default configuration is not appropriate for your cookware, press **P** repeatedly to choose the desired configuration manually.

The following modes are available:

- Centre
- Vertical
- Horizontal
- Standard cooking zone

The cooking zone indicators change automatically to show the possible combination.

All single triangles of one mode are controlled by one control bar which lights up.

When you change the heat setting, **P** disappears. When the heat setting is set to 0, **P** comes on again.

6.9 PowerBoost

This function activates more power for the appropriate induction cooking zone, depending on the cookware size. The function can be activated only for a limited period of time.

It is not possible to use the function when Bridge is activated in the Centre, Vertical or Horizontal mode.

To activate the function for the cooking zone: touch **P**. The symbol turns red.

The function deactivates automatically.

 For maximum duration values, refer to "Technical data".





6.10 Timer

• Count Down Timer







You can use this function to set the length of a single cooking session.

First set the heat setting for the cooking zone, then set the function.

To activate the function or change the





time: touch . The timer digits **00** and the indicators  and  light up on the display.  turns red, and  turns white.

 If the timer is not set, all indicators disappear after 3 seconds.

Touch  or  to set the time (00 - 99 minutes). After 3 seconds, the timer starts to count down automatically. The indicators , , and  disappear.  stays red.



When the timer finishes counting down, a signal sounds and **00** flashes. To stop the signal, touch .



To deactivate the function: touch .

The indicators  and  light up. Use  or  to set **00** on the display. Alternatively, set the heat level to **0**. As a result, a signal sounds and the timer is cancelled.

• CountUp Timer









You can use this function to monitor how long a cooking zone operates.

To activate the function: touch  twice. The indicator  turns red, the timer starts automatically.

To deactivate the function: touch . When the indicators light up, touch .

• Minute Minder





You can use this function as a Minute Minder when the hob is activated but the cooking zones do not operate. To see the Timer symbols, place a pot on a cooking zone.

To activate the function: touch  until the indicator  turns red. Touch  or  to set the time. The function starts automatically after 4 seconds. The indicators , , and  disappear.  stays red.

When you set the function, you can remove the pot.

When the time comes to an end, a signal sounds and **00** flashes. Touch  to stop the signal.

To deactivate the function: touch .

The indicators  and  light up. Use  or  to set **00** on the display.





 The function has no effect on the operation of the cooking zones.

7. ADDITIONAL FUNCTIONS

7.1 Pause

This function sets all cooking zones that operate to the lowest heat setting.

When the function operates, all other symbols on the control panels are locked.

 When the function is active,  and  symbols can be used. The function does not stop the timer functions:  and .

To activate the function: touch . The symbol turns red. The heat setting is lowered to 1.

To deactivate the function: touch . The symbol turns white. The previous heat setting comes on.

7.2 Lock

You can lock the control panel while the hob operates. It prevents an accidental change of the heat setting.

Set the heat setting first.

To activate the function: touch . The symbol turns red and blinks.

To deactivate the function: touch . The symbol turns white.



When you deactivate the hob, you also deactivate this function.





7.3 Child Safety Device



This function prevents an accidental operation of the hob.

To activate the function: activate the hob. Do not set the heat setting. Touch  until it turns red and the control bar disappears.

To deactivate the function: activate the hob. Do not set the heat setting. Touch  until it turns white and the control bar appears. Deactivate the hob.

7.4 OffSound Control (Deactivating and activating the sounds)

Deactivate the hob. Press  for 3 seconds. The display comes on and goes out. Press  for 3 seconds.  or  appears. Press  of the timer to choose one of the following:

-  - the sounds are off
-  - the sounds are on

To confirm your selection wait until the hob deactivates automatically.

When the function is set to  you can hear the sounds only when:

- you touch 
- Minute Minder comes down

- Count Down Timer comes down
- you put something on the control panel.

7.5 Power management

If multiple zones are active and the consumed power exceeds the limitation of the power supply, this function divides the available power between all cooking zones. The hob controls heat settings to protect the fuses of the house installation.

- Cooking zones are grouped according to the location and number of the phases in the hob. Each phase has a maximum electricity loading of 3680 W. If the hob reaches the limit of maximum available power within one phase, the power of the cooking zones will be automatically reduced.
- For cooking zones that have a reduced power, the control panel shows the maximum possible heat settings.
- If a higher heat setting is not available reduce it for the other cooking zones first.
- The activation of the function depends on the number and size of pots.

Refer to the illustration for possible combinations in which power can be distributed among the cooking zones.

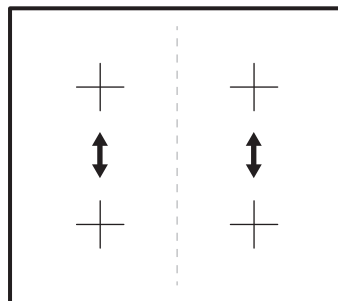

7.6 Hob²Hood

It is an advanced automatic function which connects the hob to a special hood. Both the hob and the hood have an infrared signal communicator. The speed of the fan is defined automatically on the basis of the mode setting and the temperature of the hottest cookware on

the hob. You can also operate the fan manually.



For most of the hoods, the remote system is originally deactivated. Activate it before you use the function. For more information refer to the hood user manual.

Operating the function automatically

To operate the function automatically set the automatic mode to H1 – H6. The hob is originally set to H5. The hood reacts whenever you operate the hob. The hob recognizes the temperature of the cookware and adjusts the speed of the fan automatically.

Automatic modes

	Auto- matic light	Boiling ¹⁾	Frying ²⁾
Mode H0	Off	Off	Off
Mode H1	On	Off	Off
Mode H2 ³⁾	On	Fan speed 1	Fan speed 1
Mode H3	On	Off	Fan speed 1
Mode H4	On	Fan speed 1	Fan speed 1
Mode H5	On	Fan speed 1	Fan speed 2
Mode H6	On	Fan speed 2	Fan speed 3

1) The hob detects the boiling process and activates fan speed in accordance with automatic mode.

2) The hob detects the frying process and activates fan speed in accordance with automatic mode.

3) This mode activates the fan and the light and does not rely on the temperature.

Changing the automatic mode

1. Deactivate the appliance.
2. Touch for 3 seconds. The display comes on and goes off.
3. Touch for 3 seconds.

4. Touch repeatedly until comes on.
5. Touch to select an automatic mode.



To operate the hood directly on the hood panel deactivate the automatic mode of the function.



When you finish cooking and deactivate the hob, the hood fan may still operate for a certain period of time. After that time the system deactivates the fan automatically and prevents you from accidental activation of the fan for the next 30 seconds.

Operating the fan speed manually

You can also operate the function manually. To do that, touch when the hob is active. The symbol turns white. This deactivates automatic operation of the function and allows you to change the fan speed manually. When you press again, you raise the fan speed by one. When you reach an intensive level and press again, you set the fan speed to 0, which deactivates the hood fan. The symbol turns red. To start the fan again at the fan speed 1 touch .



To activate the automatic operation of the function, deactivate the hob and activate it again.



If the function is not active, deactivates after 10 seconds. When the hob is restarted, lights up again.

Activating the light

You can set the hob to activate the light automatically whenever you activate the hob. To do so, set the automatic mode to H1 – H6.



The light on the hood deactivates 2 minutes after deactivating the hob.

8. CARE AND CLEANING



WARNING!
Refer to Safety chapters.

8.1 General information

- Clean the hob after each use.
- Always use cookware with a clean base.
- Scratches or dark stains on the surface have no effect on how the hob operates.
- Use a special cleaner suitable for the surface of the hob.
- Use a special scraper for the glass.

8.2 Cleaning the hob

- **Remove immediately:** melted plastic, plastic foil, sugar and food with sugar,

otherwise, the dirt can cause damage to the hob. Take care to avoid burns. Use a special hob scraper on the glass surface at an acute angle and move the blade on the surface.

- **Remove when the hob is sufficiently cool:** limescale rings, water rings, fat stains, shiny metallic discoloration. Clean the hob with a moist cloth and a non-abrasive detergent. After cleaning, wipe the hob dry with a soft cloth.
- **Remove shiny metallic discoloration:** use a solution of water with vinegar and clean the glass surface with a cloth.

9. HINTS AND TIPS



WARNING!
Refer to Safety chapters.

9.1 Cookware



For induction cooking zones a strong electro-magnetic field creates the heat in the cookware very quickly.

Use the induction cooking zones with suitable cookware.

- The bottom of the cookware must be as thick and flat as possible.
- Ensure pan bases are clean and dry before placing on the hob surface.
- In order to avoid scratches, do not slide or rub the pot across the ceramic glass.

Cookware material

- **correct:** cast iron, steel, enamelled steel, stainless steel, multi-layer bottom (with a correct marking from a manufacturer).
- **not correct:** aluminium, copper, brass, glass, ceramic, porcelain.

Cookware is suitable for an induction hob if:

- water boils very quickly on a zone set to the highest heat setting.
- a magnet pulls on to the bottom of the cookware.

Cookware dimensions



Refer to "Induction cooking surface" in "Daily use".

- Induction cooking zones adapt to the dimension of the bottom of the cookware automatically.
- The cooking zone efficiency is related to the diameter of the cookware. The cookware with a diameter smaller than the minimum receives only a part of the power generated by the cooking zone.
- For both safety reasons and optimal cooking results, do not use cookware larger than indicated in "Cooking zones specification". Avoid keeping cookware close to the control panel during the cooking session. This might impact the functioning of the control panel or accidentally activate hob functions.



Refer to "Technical data".

Cookware types

Depending on the cookware type you use, the hob determines the appropriate bridge mode. For example:

Single triangles, standard cooking zones, centre mode

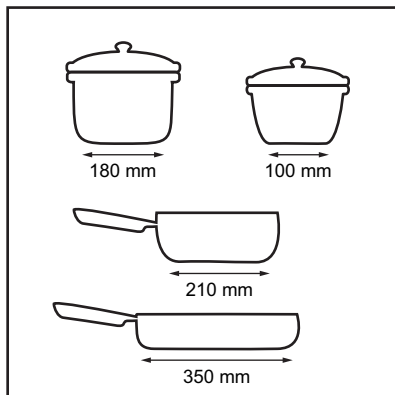

Vertical mode, horizontal modes



The cookware must cover 3 or 4 single triangles.

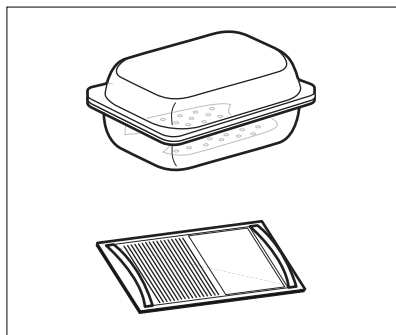

WARNING!

Do not use baking tray.

9.2 The noises during operation

If you can hear:

- crack noise: cookware is made of different materials (a sandwich construction).
- whistle sound: you use a cooking zone with a high power level and the cookware is made of different materials (a sandwich construction).
- humming: you use a high power level.
- clicking: electric switching occurs.
- hissing, buzzing: the fan operates.

The noises are normal and do not indicate any malfunction.

9.3 Öko Timer (Eco Timer)

To save energy, the heater of the cooking zone deactivates before the count down timer sounds. The difference in the operation time depends on the heat setting level and the length of the cooking operation.

9.4 Examples of cooking applications

The correlation between the heat setting of a zone and its consumption of power is not linear. When you increase the heat setting, it is not proportional to the increase of the consumption of power. It means that a cooking zone with the medium heat setting uses less than a half of its power.



The data in the table is for guidance only.

Heat setting	Use to:	Time (min)	Hints
1	Keep cooked food warm.	as necessary	Put a lid on the cookware.
1 - 2	Hollandaise sauce, melt: butter, chocolate, gelatine.	5 - 25	Mix from time to time.

Heat setting	Use to:	Time (min)	Hints
1 - 2	Solidify: fluffy omelettes, baked eggs.	10 - 40	Cook with a lid on.
2 - 3	Simmer rice and milkbased dishes, heat up ready-cooked meals.	25 - 50	Add at least twice as much liquid as rice, mix milk dishes halfway through the procedure.
3 - 4	Steam vegetables, fish, meat.	20 - 45	Add a couple of tablespoons of liquid.
4 - 5	Steam potatoes.	20 - 60	Use max. ¼ l of water for 750 g of potatoes.
4 - 5	Cook larger quantities of food, stews and soups.	60 - 150	Up to 3 l of liquid plus ingredients.
6 - 7	Gentle fry: escalope, veal cordon bleu, cutlets, rissoles, sausages, liver, roux, eggs, pancakes, doughnuts.	as necessary	Turn halfway through.
7 - 8	Heavy fry, hash browns, loin steaks, steaks.	5 - 15	Turn halfway through.
9	Boil water, cook pasta, sear meat (goulash, pot roast), deep-fry chips.		
P	Boil large quantities of water. PowerBoost is activated.		

9.5 Hints and Tips for Hob²Hood

When you operate the hob with the function:

- Protect the hood panel from direct sunlight.
- Do not spot halogen light on the hood panel.
- Do not cover the hob control panel.
- Do not interrupt the signal between the hob and the hood (e.g. with the hand, a cookware handle or a tall pot). See the picture.

The hood in the picture is only exemplary.

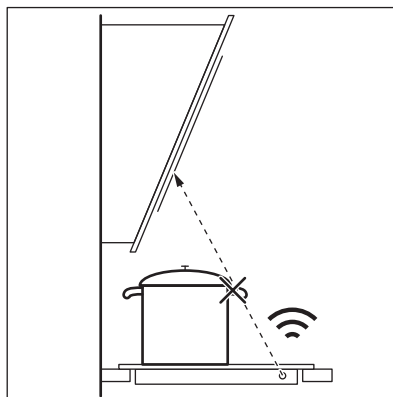

Other remotely controlled appliances may block the signal. Do not use any such appliances near to the hob while Hob²Hood is on.

Cooker hoods with the Hob²Hood function

To find the full range of cooker hoods which work with this function refer to our

consumer website. The AEG cooker hoods that work with this function must have the symbol .

10. TROUBLESHOOTING

**WARNING!**

Refer to Safety chapters.

10.1 What to do if...

Problem	Possible cause	Remedy
You cannot activate or operate the hob.	The hob is not connected to an electrical supply or it is connected incorrectly.	Check if the hob is correctly connected to the electrical supply.
	The fuse is blown.	Make sure that the fuse is the cause of the malfunction. If the fuse is blown again and again, contact a qualified electrician.
	You do not set the heat setting for 10 seconds.	Activate the hob again and set the heat setting in less than 10 seconds.
	You touched 2 or more sensor fields at the same time.	Touch only one sensor field.
	Pause operates.	Refer to "Additional functions".
	There is water or fat stains on the control panel.	Clean the control panel.
You cannot select the maximum heat setting for one of the cooking zones.	The other zones consume the maximum available power. Your hob works properly.	Reduce the heat setting of the other cooking zones connected to the same phase. Refer to "Power management".
An acoustic signal sounds and the hob deactivates. An acoustic signal sounds when the hob is deactivated.	You put something on one or more sensor fields.	Remove the object from the sensor fields.
The hob deactivates.	You put something on the control panel.	Remove the object from the control panel.
Residual heat indicator does not come on.	The zone is not hot because it operated only for a short time or the sensor is damaged.	If the zone operated sufficiently long to be hot, speak to an Authorised Service Centre.

Problem	Possible cause	Remedy
Hob/Hood does not work.	You covered the control panel.	Remove the object from the control panel.
	You use a very tall pot which blocks the signal.	Use a smaller pot, change the cooking zone or operate the hood manually.
The sensor fields become hot.	The cookware is too large or you put it too near to the controls.	Put large cookware on the rear zones, if possible.
There is no sound when you touch the panel sensor fields.	The sounds are deactivated.	Activate the sounds. Refer to "Additional functions".
 comes on.	Child Safety Device or Lock operates.	Refer to "Additional functions".
The control bar blinks.	There is no cookware on the zone or the zone is not fully covered.	Put cookware on the zone so that it fully covers the cooking zone.
	The cookware is unsuitable.	Use suitable cookware. Refer to "Hints and tips".
	The diameter of the bottom of the cookware is too small for the zone.	Use cookware with correct dimensions. Refer to "Technical data".
E and a number come on.	There is an error in the hob.	Deactivate the hob and activate it again after 30 seconds. If E comes on again, disconnect the hob from the electrical supply. After 30 seconds, connect the hob again. If the problem continues, speak to an Authorised Service Centre.
You can hear a constant beep noise.	The electrical connection is incorrect.	Disconnect the hob from the electrical supply. Ask a qualified electrician to check the installation.

10.2 If you cannot find a solution...

If you cannot find a solution to the problem yourself, contact your dealer or an Authorised Service Centre. Give the data from the rating plate. Make sure, you operated the hob correctly. If not the

servicing by a service technician or dealer will not be free of charge, also during the warranty period. The information about guarantee period and Authorised Service Centres are in the guarantee booklet.

11. TECHNICAL DATA

11.1 Rating plate

Model IKK64681FB
Typ 62 B4A 06 AA
Induction 7.35 kW
Ser.Nr.
AEG

PNC 949 597 916 00
220 - 240 V / 400 V 2N 50 - 60 Hz
Made in Germany
7.35 kW

11.2 Cooking zones specification

Induction cooking surface	Nominal power (maximum heat setting) [W]	PowerBoost [W]	PowerBoost maximum duration [min]
Single triangle	1150	1600	10
Standard cooking zone	2000	3000	10
Centre zone	4200	-	-
Vertical zone	3200	-	-
Horizontal zone	4100	-	-

The power of the cooking zones can be different from the data in the table. It changes with the material and dimensions of the cookware.

Cookware sizes

Bridge mode	Cookware dimension (minimum)	Cookware dimension (maximum)
Single triangle	100 mm	160 mm
Standard cooking zone	160 mm	210 mm
Centre zone	240 mm	350 mm
Vertical zone	The area of 3 single triangles	The area of 4 single triangles
Horizontal zone	The area of 3 single triangles	The area of 4 single triangles

For more information on the recommended cookware dimensions, refer to "Induction cooking surface" in "Daily use".

12. ENERGY EFFICIENCY

12.1 Energy saving

You can save energy during everyday cooking if you follow below hints.

- When you heat up water, use only the amount you need.
- If it is possible, always put the lids on the cookware.

- Before you activate the cooking zone put the cookware on it.
- Put the smaller cookware on the smaller cooking zones.
- Put the cookware directly in the centre of the cooking zone.
- Use the residual heat to keep the food warm or to melt it.

13. WARRANTY

FOR SALES IN AUSTRALIA AND NEW ZEALAND

ALL AEG BRANDED APPLIANCES

This document sets out the terms and conditions of the product warranties for AEG Appliances. It is an important document. Please keep it with your proof of purchase documents in a safe place for future reference should there be a manufacturing defect in your Appliance. This warranty is in addition to other rights you may have under the Australian Consumer Law.

1. In this warranty:

- 'ACL' or 'Australian Consumer Law' means Schedule 2 to the Competition and Consumer Act 2010;
- 'Appliance' means any Electrolux product purchased by you and accompanied by this document;
- 'ASC' means Electrolux's authorised serviced centres;
- 'AEG' is the brand controlled by Electrolux Home Products Pty Ltd of 163 O'Riordan Street, Mascot NSW 2020, ABN 51 004 762 341 in respect of Appliances purchased in Australia and Electrolux (NZ) Limited (collectively "Electrolux") of 3-5 Niall Burgess Road, Mount Wellington, in respect of Appliances purchased in New Zealand;
- 'Warranty Period' means the period specified in clause 3 of this warranty;
- 'you' means the purchaser of the Appliance not having purchased the Appliance for re-sale, and 'your' has a corresponding meaning.

2. Application: This warranty only applies to new Appliances,

purchased and used in Australia or New Zealand and is in addition to (and does not exclude, restrict, or modify in any way) other rights and remedies under a law to which the Appliances or services relate, including any non-excludable statutory guarantees in Australia and New Zealand.

- 3. Warranty Period:** Subject to these terms and conditions, this warranty continues for in Australia for a period of 60 months and in New Zealand for a period of 60 months, following the date of original purchase of the Appliance.
- 4. Repair or replace warranty:** During the Warranty Period, Electrolux or its ASC will, at no extra charge if your Appliance is readily accessible for service, without special equipment and subject to these terms and conditions, repair or replace any parts which it considers to be defective. Electrolux may, in its absolute discretion, choose whether the remedy offered for a valid warranty claim is repair or replacement. Electrolux or its ASC may use refurbished parts to repair your Appliance. You agree that any replaced Appliances or parts become the property of Electrolux.
- 5. Travel and transportation costs:** Subject to clause 7, Electrolux will bear the reasonable cost of transportation, travel and delivery of the Appliance to and from Electrolux or its ASC. Travel and transportation will be arranged by Electrolux as part of any valid warranty claim.
- 6. Proof of purchase** is required before you can make a claim under this warranty.
- 7. Exclusions:** You may not make a claim under this warranty unless the defect claimed is due to faulty or

defective parts or workmanship. This warranty does not cover:

- a) light globes, batteries, filters or similar perishable parts;
- b) parts and Appliances not supplied by Electrolux;
- c) cosmetic damage which does not affect the operation of the Appliance;
- d) damage to the Appliance caused by:
 - negligence or accident;
 - misuse or abuse, including failure to properly maintain or service;
 - improper, negligent or faulty servicing or repair works done by anyone other than an Electrolux authorised repairer or ASC;
 - normal wear and tear;
 - power surges, electrical storm damage or incorrect power supply;
 - incomplete or improper installation;
 - incorrect, improper or inappropriate operation;
 - insect or vermin infestation;
 - failure to comply with any additional instructions supplied with the Appliance;

In addition, Electrolux is not liable under this warranty if:

- the Appliance has been, or Electrolux reasonably believes that the Appliance has been, used for purposes other than those for which the Appliance was intended, including where the Appliance has been used for any non-domestic purpose;
- the Appliance is modified without authority from Electrolux in writing;
- the Appliance's serial number or warranty seal has been removed or defaced.

8. **How to claim under this warranty:** To enquire about claiming under this warranty, please follow these steps:
 - a. carefully check the operating instructions, user manual and the terms of this warranty;
 - b. have the model and serial number of the Appliance available;
 - c. have the proof of purchase (e.g. an invoice) available;
 - d. telephone the numbers shown below.
9. **Australia:** For Appliances and services provided by Electrolux in Australia: Electrolux goods come with guarantees that cannot be excluded under the Australian Consumer Law. You are entitled to a replacement or refund for a major failure and for compensation for any other reasonably foreseeable loss or damage. You are also entitled to have the Appliance repaired or replaced if the Appliance fails to be of acceptable quality and the failure does not amount to a major failure. 'Acceptable quality' and 'major failure' have the same meaning as referred to in the ACL.
10. **New Zealand:** For Appliances and services provided by Electrolux in New Zealand, the Appliances come with a guarantee by Electrolux pursuant to the provisions of the Consumer Guarantees Act, the Sale of Goods Act and the Fair Trading Act. Where the Appliance was purchased in New Zealand for commercial purposes the Consumer Guarantee Act does not apply.
11. **Confidentiality:** You accept that if you make a warranty claim, Electrolux and its agents including ASC may exchange information in relation to you to enable Electrolux to meet its obligations under this warranty.

Important Notice

Before calling for service, please ensure that the steps listed in clause 8 above have been followed.

SERVICE AUSTRALIA**aeg.com/au****FOR SERVICE**

or to find the address of your nearest authorised service centre in Australia

PLEASE CALL 1300 363 664**OR EMAIL****customercare@aegaustralia.com.au**

For the cost of a local call (Australia only)

FOR SPARE PARTS

or to find the address of your nearest spare parts centre in Australia

PLEASE CALL 13 13 50**OR EMAIL****customercare@aegaustralia.com.au**

For the cost of a local call (Australia only)

SERVICE NEW ZEALAND**aegnewzealand.co.nz****FOR SERVICE**

or to find the address of your nearest authorised service centre in New Zealand

PLEASE CALL 0800 234 234**OR EMAIL****customercare@electrolux.co.nz**

(New Zealand only)

FOR SPARE PARTS

or to find the address of your nearest spare parts centre in New Zealand

PLEASE CALL 0800 10 66 20**OR EMAIL****customercare@electrolux.co.nz**

(New Zealand only)

AEG_Warr_May_17

14. ENVIRONMENTAL CONCERNS

Recycle materials with the symbol .
Put the packaging in relevant containers to recycle it. Help protect the environment and human health by recycling waste of electrical and electronic appliances. Do not dispose of

appliances marked with the symbol  with the household waste. Return the product to your local recycling facility or contact your municipal office.

