

USER MANUAL



CONTENTS

1. SAFETY INFORMATION.....	2
2. CONDITIONS OF USE.....	5
3. SAFETY INSTRUCTIONS.....	5
4. PRODUCT DESCRIPTION.....	7
5. CONTROL PANEL.....	8
6. PROGRAM.....	9
7. OPTIONS.....	11
8. BEFORE FIRST USE.....	12
9. DAILY USE.....	13
10. HINTS AND TIPS.....	15
11. CARE AND CLEANING.....	16
12. TROUBLESHOOTING.....	19
13. TECHNICAL DATA.....	20
14. ACCESSORIES.....	21
15. WARRANTY	22

FOR PERFECT RESULTS

Thank you for choosing this AEG product. We have created it to give you impeccable performance for many years, with innovative technologies that help make life simpler features you might not find on ordinary appliances. Please spend a few minutes reading to get the very best from it.

Visit our website for:



Get usage advice, brochures, trouble shooter, service information:
www.aeg.com/webselfservice



Register your product for better service:
www.registeraeg.com

CUSTOMER CARE AND SERVICE

Always use original spare parts.

When contacting our Authorised Service Centre, ensure that you have the following data available: Model, PNC, Serial Number.

The information can be found on the rating plate.

 Warning / Caution-Safety information

 General information and tips

 Environmental information

Subject to change without notice.

1. SAFETY INFORMATION

Before the installation and use of the appliance, carefully read the supplied instructions. The manufacturer is not responsible if an incorrect

installation and use causes injuries and damages. Always keep the instructions with the appliance for future reference.



- Read the supplied instructions.



- Warning; Risk of fire / Flammable materials

1.1 Children and vulnerable people safety



WARNING!

Risk of suffocation, injury or permanent disability.

- This appliance can be used by children aged from 8 years and above and persons with reduced physical, sensory or mental capabilities or lack of experience and knowledge if they have been given supervision or instruction concerning the use of the appliance in a safe way and understand the hazards involved.
- Do not let children play with the appliance.
- Children of less than 3 years should be kept away unless continuously supervised.
- Keep all packaging away from children and dispose of it appropriately.
- Keep detergents away from children.
- Keep children and pets away from the appliance when the door is open.
- If the appliance has a child safety device, this should be activated.
- Children shall not carry out cleaning and user maintenance of the appliance without supervision.

1.2 General Safety

- Do not change the specification of this appliance.
- If the tumble dryer is put on top of a washing machine, use the stacking kit. The stacking kit, available from your authorized vendor, can be used only with the appliance specified in the instructions,

supplied with the accessory. Read it carefully before installation (Refer to the Installation leaflet).

- The appliance can be installed as freestanding or below the kitchen counter with correct space (Refer to the Installation leaflet).
- Do not install the appliance behind a lockable door, a sliding door or a door with a hinge on the opposite side, that would prevent the appliance door from being fully opened.
- The ventilation opening in the base (if applicable) must not be covered by a carpet, mat, or any floor covering.
- **WARNING:** The appliance must not be supplied through an external switching device, such as timer, or connected to a circuit that is regularly switched on and off by a utility.
- Connect the mains plug to the mains socket only at the end of the installation process. Make sure that the mains plug is accessible after installation.
- Ensure good air ventilation in the located room to avoid the backflow of unwanted gases into the room from appliances burning gas or other fuels, including open fires.
- Exhaust air must not be discharged into a flue which is used for exhausting fumes from any appliances burning gas or other fuels.
- If the mains power supply cable is damaged, it must be replaced by the manufacturer, its Authorised Service Centre or similarly qualified persons to avoid an electrical hazard.
- Do not exceed the maximum load of 8 kg (refer to the "Programme chart" chapter).
- Do not use the appliance if items have been soiled with industrial chemicals.
- Wipe away lint or packaging debris that has accumulated around the appliance.
- Do not run the appliance without a filter. Clean the lint filter before or after each use.

- Do not dry unwashed items in the tumble dryer.
- Items that have been soiled with substances such as cooking oil, acetone, alcohol, petrol, kerosene, spot removers, turpentine, waxes and wax removers should be washed in hot water with an extra amount of detergent before being dried in the tumble dryer.
- Items such as foam rubber (latex foam), shower caps, waterproof textiles, rubber backed articles and clothes or pillows fitted with foam rubber pads should not be dried in the tumble dryer.
- Fabric softeners, or similar products, should only be used as specified by the product manufacturer's instructions.
- Remove all objects from items that could be a source of fire ignition such as lighters or matches.
- Never stop a tumble dryer before the end of the drying cycle unless all items are quickly removed and spread out so that the heat is dissipated.
- Before any maintenance operation, deactivate the appliance and disconnect the mains plug from the socket.

2. CONDITIONS OF USE

This appliance is intended to be used in household and similar applications such as:

- Farm houses
- By clients in serviced apartments, holiday apartments and other residential type environments.

3. SAFETY INSTRUCTIONS

3.1 Installation

- Remove all the packaging.
- Do not install or use a damaged appliance.
- Follow the installation instruction supplied with the appliance.
- Always take care when moving the appliance as it is heavy. Always use safety gloves and enclosed footwear.
- Do not install or use the appliance where the temperature can be less than 5°C or higher than 35°C.
- The floor area where the appliance is to be installed must be flat, stable, heat resistant and clean.
- Make sure that there is air circulation between the appliance and the floor.
- Always keep the appliance vertical when being moved.
- The rear surface of the appliance must be put against the wall.
- When the appliance is in its permanent position, check that it is fully level with the aid of a spirit level. If it is not, adjust the feet accordingly.

3.2 Electrical connection



WARNING!

Risk of fire and electrical shock.

- Connect the mains plug to the mains socket only at the end of the installation. Make sure that there is access to the mains plug after the installation.
- The appliance must be earthed.
- Make sure that the parameters on the rating plate are compatible with the electrical ratings of the mains power supply.
- Always use a correctly installed shockproof socket.
- Do not use multi-plug adapters and extension cables.
- Do not pull the mains cable to disconnect the appliance. Always pull the mains plug.
- Do not touch the mains cable or the mains plug with wet hands.
- This appliance complies with the E.E.C. Directives.

3.3 Use



WARNING!

Risk of injury, electrical shock, fire, burns or damage to the appliance.

- Do not dry the damaged items which contain padding or fillings.
- Only dry fabrics which are applicable to dry in the tumble dryer. Follow the instructions on the fabric label.
- If you have washed your laundry with a stain remover start an extra rinse cycle before you start the dryer.
- Do not drink or prepare food with the condensed water/distilled water. It can cause health problems to people and pets.
- Do not sit or stand on the open door.
- Do not dry dripping wet clothes in the tumble dryer.
- Oil-affected items can ignite spontaneously, especially when exposed to heat sources such as in a tumble dryer. The items become warm, causing an oxidation reaction in the oil. Oxidation creates heat. If

the heat cannot escape, the items can become hot enough to catch fire. Piling, stacking or storing oil-affected items can prevent heat from escaping and create a fire hazard.

- If it is unavoidable that fabrics that contain vegetable or cooking oil or have been contaminated by hair care products be placed in a tumble dryer they should first be washed in hot water with extra detergent -this will reduce, but not eliminate, the hazard.

3.4 Internal light



WARNING!

Risk of injury.

- Visible LED radiation, do not look directly into the beam.
- The LED lamp is dedicated to drum lighting. This lamp cannot be reused for other lighting purposes.
- To replace the internal light, contact the Authorised Service Centre.

3.5 Care and cleaning



WARNING!

Risk of injury or damage to the appliance.

- Do not use water spray and steam to clean the appliance.
- Clean the appliance with a moist soft cloth. Only use neutral detergents. Do not use any abrasive products, abrasive cleaning pads, solvents or metal objects.
- To prevent damage to the cooling system be careful when you clean the appliance.

3.6 Compressor



WARNING!

Risk of damage to the appliance.

- The compressor and its system in the tumble dryer is filled with the special agent which is free from fluoro-chloro-hydrocarbons. This system must stay tight. The damage of the system can cause a leakage.

3.7 Disposal



WARNING!

Risk of injury or suffocation.

- Disconnect the appliance from the mains electrical and water supplies.
- Cut off the mains electrical cable close to the appliance and dispose of it.
- Remove the door catch to prevent children or pets from becoming trapped in the drum.
- Dispose of the appliance in accordance with local requirements for the disposal of Waste Electrical and Electronic Equipment (WEEE).

4. PRODUCT DESCRIPTION

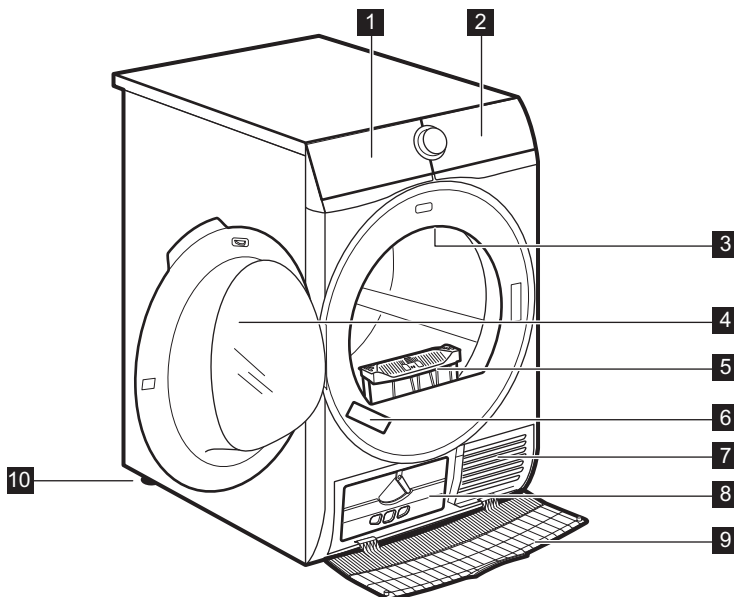

1 Water container

2 Control panel

3 Internal light

4 Appliance door

5 Filter

6 Rating plate

7 Airflow slots

8 Condenser lid

9 Condenser cover

10 Adjustable feet



For ease of loading laundry or ease of installation the door is reversible. (see separate leaflet).

5. CONTROL PANEL

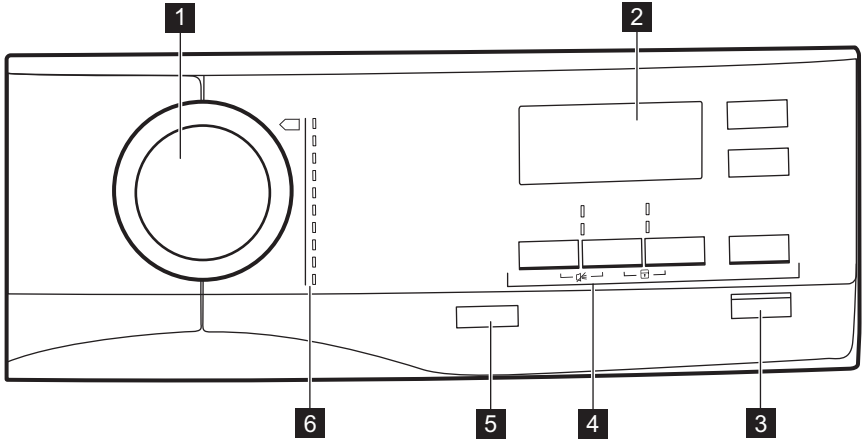





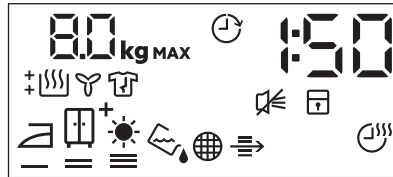





- 1** Program dial
- 2** Display
- 3** Start/Pause button
- 4** Options
- 5** On/Off button with *Auto Off* function
- 6** Programs



5.1 Display















Symbol on the display	Symbol description
80 kg MAX	laundry maximum load
	delay start option on
30' - 20h	delay start selection (30min-20h)
1 : 50	cycle time indication
	buzzer off

Symbol on the display	Symbol description
	child lock on
	laundry dryness: iron dry, cupboard dry, cupboard dry +, extra dry
	indicator: <i>drain the water container</i>
	indicator: <i>clean filter</i>
	indicator: <i>do the check of the heat exchanger</i>
	time dry option on
	time programme selection (10min-2h)
	indicator: <i>drying phase</i>
	indicator: <i>crease guard phase</i>
	indicator: <i>cooling phase</i>

6. PROGRAM

Program	Load ¹⁾	Properties / Fabric mark
Cottons ²⁾	8 kg	Cotton fabrics. / 
Synthetics	3,5 kg	Synthetic and mixed fabrics. / 
Mixed	3 kg	Cotton and synthetic fabrics. / 





Program	Load ¹⁾	Properties / Fabric mark
Wool  	1 kg	<p>Wool fabrics. Gentle drying for hand-washable woollens. Remove immediately the items when the program is completed.</p> <div data-bbox="572 261 949 504" style="border: 1px solid black; padding: 5px; text-align: center;">   <p>WOOL HAND WASH SAFE</p> </div> <p>The wool drying cycle of this machine has been approved by The Woolmark Company for the drying of wool garments labelled as "hand wash" provided that the garments are dried according to the instructions issued by the manufacturer of this machine. Follow the garment care label for other laundry instructions. M1525 In UK, Eire, Hong Kong and India the Woolmark trade mark is a Certification trade mark.</p>
Silk 	1 kg	Hand-washable silk gently. / 
Easy Iron	1 kg (or 5 shirts)	<p>Easy care fabrics for which a minimum of ironing is necessary. The drying results can be different from one type of fabric to another. Shake the items before putting them in the appliance. When the programme has ended, immediately remove the items and put them on a hanger.</p> <p>/ </p>
Bed Linen	3 kg	Bed linen such as single and double sheets, pillowcases, duvet cover. / 
Sports	2 kg	Sportswear, thin and light fabrics, microfiber, polyester. / 
Outdoor 	2 kg	<p>Outdoor clothing, technical, sports fabrics, waterproof and breathable jackets, shell jackets with a removable fleece or inner insulation. Suitable for drying in tumble dryer.</p> <p>/ </p>

Program	Load 1)	Properties / Fabric mark
Duvet	3 kg	Single or double duvets and pillows (with feather, down or synthetic fillings). 

1) The maximum weight refers to dry items.

2) For test institutes only: the Cottons program in combination with the extra dry  Dryness and ECO selection is the "Standard cotton program". It is suitable for drying normal wet cotton laundry and it is the most efficient program in terms of energy consumption for drying wet cotton laundry. Standard programme for tests are specified in the AS/NZS2442.2 document.

6.1 Programs and options selection

Programs 1)	Options				
	Dryness	Extra Silent	Anti-crease	Refresh	Time Dry
 Cottons	■	■	■	■	■
Synthetics	■	■	■	■	■
Mixed			■	■	■
Wool  					■ 2)
Silk 			■		
Easy Iron			■		
Bed Linen			■		
Sports			■		
Outdoor 					
Duvet					



1) Together with the program you can set 1 or more options.



2) See chapter OPTIONS: Time Dry on Wool programme



7. OPTIONS

7.1 Dryness

This option helps to achieve requested laundry dryness. Possible selections:

 =  =  - ready to iron - **iron dry** level.

 =  =  - ready to store - **cupboard dry** level - default selection which is related to the programme.

⁺ =  =  - ready to store - **cupboard dry** + level.

 - ready to store - **extra dry** level.

7.2 Extra Silent

The appliance operates with low noise without effect on the drying quality. The appliance operates slowly with longer cycle time.

7.3 ECO

This option is on by default with all programs.

The power consumption is at the minimum level.

7.4 Anticrease

Extends up to 120 minutes the anti-crease phase (30 minutes) at the end of the drying cycle. After drying phase drum rotates from time to time to prevent creases. Laundry can be removed during the anti-crease phase.

7.5 Refresh

To refresh clothes that were in storage. Maximal load cannot exceed 1 kg.

7.6 Time Dry

For cottons, synthetics and mixed. Lets the user to set drying time from minimum 10 min to maximum of 2 hours

(in 10 min steps). When this option is maximum, load indicator disappears.

7.7 Time Dry on Wool program

Option applicable to Wool program to adjust final dryness level to more dry or less dry.

7.8 Delay Start

 Lets to delay the start of a drying program from minimum of 30 minutes to maximum of 20 hours.

1. Set the drying program and options.
2. Touch Delay Start button again and again.

Time of delay is on the display (e.g.  h if the program has to start after 12 hours.)

3. To activate Delay Start option, touch the Start/Pause button.

Time to start decreases on the display.

7.9 Buzzer

The sound is heard at the:

- cycle end
- start and end of crease guard phase

The buzzer option is by default always on. You can use this option to activate or deactivate the sound.

8. BEFORE FIRST USE

 Rear drum packaging is removed automatically when dryer is activated for the first time. Possible to hear some noise.

Before you use the appliance for the first time:





- Clean the tumble dryer drum with a moist cloth.
- Start a short programme (e.g. 30 minutes) with moist laundry.

 At the beginning of the drying cycle (first 3-5 min) there could be a slightly higher sound level. This is due to the compressor starting up. This is normal for compressor powered appliances such as refrigerators and freezers.

9. DAILY USE

9.1 Preparing the laundry

- Close the zippers.
 - Close the fasteners of duvet covers.
 - Do not dry ties or ribbons loose (e.g. apron ribbons). Tie them before you start a programme.
 - Remove all items from pockets.
 - If an item has an internal layer made of cotton, turn it inside out. Make sure that the cotton layer is always facing outward.
 - We recommend that you set a correct programme suitable for the type of fabrics that are in the appliance.
 - Do not put dark colours together with light colours.
- Use a suitable programme for cotton, jersey and knitwear to prevent shrinkage.
 - Make sure that the load do not exceeds the maximum load stated in programs chapter or shown on the display.
 - Only dry laundry that is suitable for tumble drying. Refer to the fabric label on the items.
 - Do not dry large and small items together. Small items can be trapped inside the large items and remain wet.

Fabric label	Description
	Laundry is suitable for tumble drying.
	Laundry is suitable for tumble drying at higher temperatures.
	Laundry is suitable for tumble drying at low temperatures only.
	Laundry is not suitable for tumble drying.

9.2 Loading the laundry



CAUTION!

Ensure the laundry is not trapped between the appliance door and rubber seal.

1. Pull open the appliance door.
2. Load the laundry one item at a time.
3. Close the appliance door.

9.3 Turning on the appliance

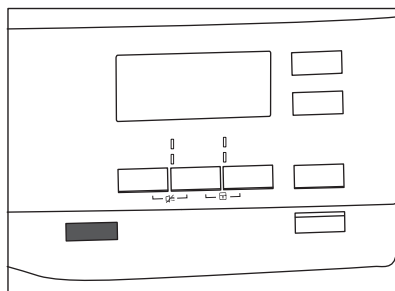

To turn on the appliance:

Push the On/Off button.

If the appliance is on, some indicators appear on the display.

9.4 Auto Off function

To decrease the energy consumption, the Auto Off function turns off the appliance automatically:

- if the Start/Pause touch button was not touched within 5 minutes.
- 5 minutes after cycle ends.

Push the On/Off button to turn on the appliance.

If the appliance is on, some indications come in to the view on the display.

9.5 Setting a program

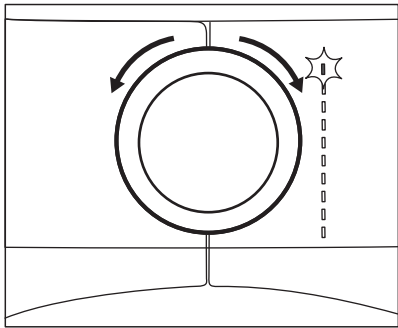

Use the program dial to set the program. The possible time to complete the program comes into the view on the display.



The drying time you see is related to the load of 5 kg for cotton program. For the other programs the drying time is related to the recommended loads. The drying time of the cotton program with the load more than 5 kg is longer.

9.6 Options

Together with the program you can set 1 or more special options.

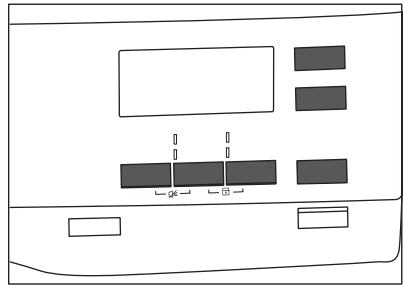

To activate or deactivate an option touch the relevant button or 2 buttons combination.

When the option is activated, the LED above the button or symbol illuminates on the display.

9.7 Child lock option

The child lock can be set to prevent children from playing with the appliance. The child lock option locks all touch buttons and the program dial (this option does not lock the **On/Off** button).

You can activate the child lock option:

- before you touch the **Start/Pause** button - the appliance cannot start
- after you touch the **Start/Pause** button - programs and option selection is unavailable.

Child lock option activation:

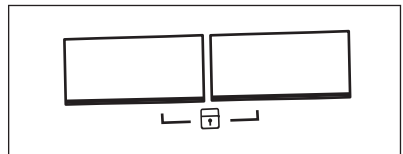

1. Turn the dryer on.
2. Select 1 of the available programs.
3. Touch and hold down 2 buttons at the same time.

The symbol  appears on the display.

4. To deactivate the child lock, touch the above buttons again until the symbol disappears.

9.8 Starting a program

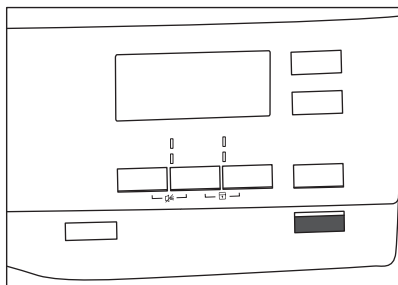

To start the program:

Touch the **Start/Pause** button. The appliance starts and the LED above the button stops flashing and stays on.

9.9 Program change

To change a program:

1. Push the On/Off button to turn the appliance off.
2. Push the On/Off button again to turn on the appliance.
3. Set a new program.

9.10 Program end



Clean the filter and drain the water container after each drying cycle. (See chapter CARE AND CLEANING.)

If the drying cycle is finished, the symbol  appears on the display. If the Buzzer option is activated, the acoustic signal sounds intermittently for 1 minute.



If you do not turn off the appliance, the anti-crease phase starts (not active with all programs). Flashing  symbol signals the execution of the anticrease phase. Laundry can be removed during this phase.

To remove the laundry:

1. Push the On/Off button for 2 seconds to turn the appliance off.
2. Open the appliance door.
3. Remove the laundry.
4. Close the appliance door.

10. HINTS AND TIPS

10.1 Ecological hints

- Spin the laundry well before drying.
- Do not exceed the load sizes which are specified in the programs chapter.
- Clean the filter after each drying cycle.
- Do not use fabric softener to wash and then dry. In the tumble dryer laundry becomes soft automatically.
- Use distilled water like that used for steam ironing. If it is necessary, clean the distilled water before (e.g. with a coffee filter) to remove any particles.
- Always keep the airflow slots at the bottom of the appliance clear.
- Make sure there is good airflow where the appliance is to be installed.

10.2 Adjustment of default dryness level

To change the default dryness level:

1. Turn the appliance on.
2. Select 1 of the available programs.
3. Touch and hold down the **Dryness** and **Anticrease** buttons at the same time.

One of the symbols appears on the display:

 - Maximum dryness

 - Extra dryness

 - Standard dryness

4. Touch the **Start/Pause** button repeatedly until you reach the desired dryness level.

Dryness level	Display symbol
Maximum dryness	☰☰☰☰ ☐0_
Extra dryness	+☰☰☰☰ ☐0=
Standard dryness	☰☰☰☰ ☐0E

5. To memorise the setting touch and hold down the **Dryness** and **Anticrease** buttons at the same time for approximately 2 seconds.

10.3 Deactivating the tank indicator





The water container indicator is activated by default. It illuminates at the end of the

drying cycle or during the cycle if the water reservoir is full. If the draining kit is installed the water container is drained automatically and the indicator can be deactivated.

To deactivate the indicator:

1. Turn the appliance on.
2. Select 1 of the available programs.
3. Touch and hold down **Anticrease** and **Time Dry** buttons at the same time.

One of 2 configurations is possible:

- the Tank indicator:  is on if the symbol  appears - the water container indicator is permanently **activated**
- the Tank indicator:  is off if the symbol  appears - the water container indicator is permanently **deactivated**

11. CARE AND CLEANING

11.1 Cleaning the filter

At the end of each cycle the  **Filter** symbol comes on the display and you must clean the filter.

-  The filter collects the fluff during the drying cycle.

1. Open the door. Pull the filter up.

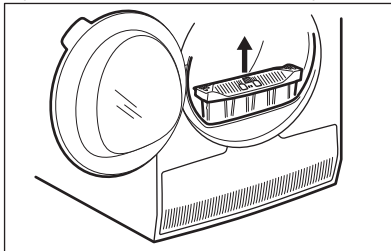

2. Push the hook to open the filter.

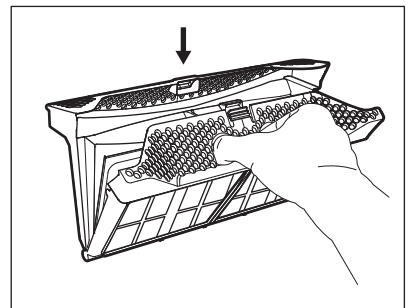

3. Use a moist hand to clean both parts of the filter.

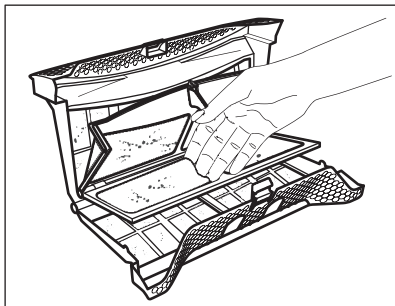

4. If necessary, clean the filter with a vacuum cleaner. Close the filter.
5. If necessary, remove fluff from the filter socket and gasket. You can use a vacuum cleaner. Place the filter back inside the filter socket.

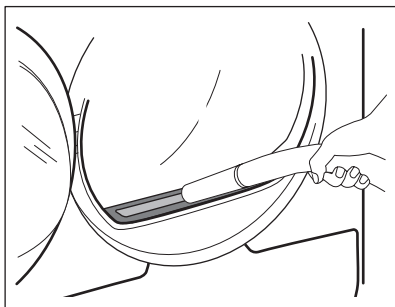

11.2 Emptying the water container

Empty the condensed water container after each drying cycle.

If the condensed water container is full, the programme stops automatically. The  Tank symbol comes on the display and you must empty the water container.

To empty the water container:

1. Pull the water container out keeping it in a horizontal position.

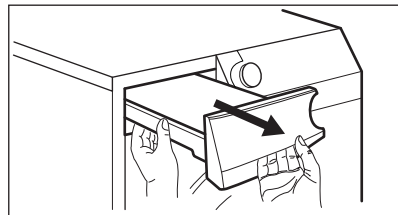

2. Pull the plastic connection out and drain the water into a basin or equivalent receptacle.

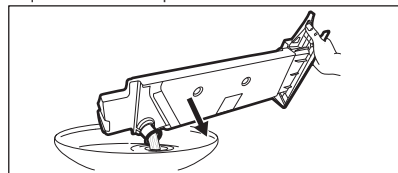

3. Push the plastic connection back in and place the water container back into position.
4. To continue the programme press the Start/Pause button.

11.3 Cleaning the condenser

If the symbol  Condenser flashes on the display, inspect the condenser and its compartment. If it is dirty, clean it. Do the check not less than once a 6 months.



WARNING!

Do not touch the metal surface with bare hands. Risk of injury. Wear protective gloves. Clean carefully to avoid damaging the metal surface.

To inspect:

1. Open the door. Pull the filter up.

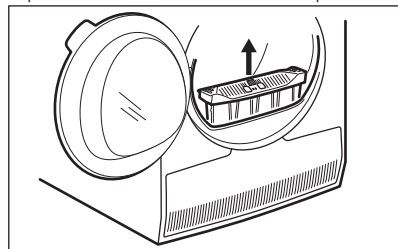

2. Open the condenser cover.

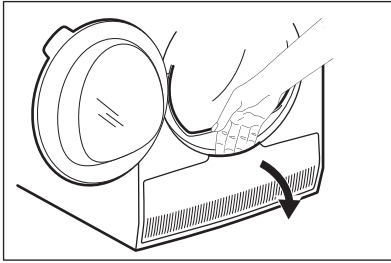

3. Turn the lever to unlock the condenser lid.

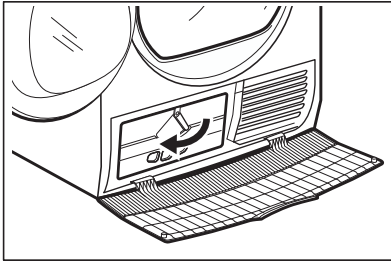

4. Lower the condenser lid.

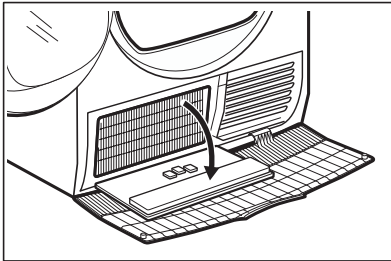

5. If necessary, remove the fluff from the condenser and its compartment. You can use a wet cloth and/or a vacuum cleaner with a brush attachment.

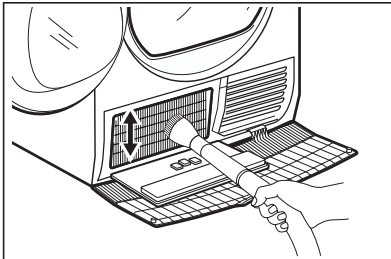

6. Close the condenser lid.
7. Turn the lever until it clicks into position.
8. Put the filter back.

11.4 Cleaning the drum



WARNING!

Disconnect the appliance before you clean it.

Use a standard neutral soap detergent to clean the inner surface of the drum and drum lifters. Dry the cleaned surfaces with a soft cloth.



CAUTION!

Do not use abrasive materials or steel wool to clean the drum.

11.5 Cleaning the control panel and housing

Use a standard neutral soap detergent to clean the control panel and housing.

Use a moist cloth to clean. Dry the cleaned surfaces with a soft cloth.



CAUTION!

Do not use furniture cleaning agents or cleaning agents which can cause corrosion to clean the appliance.

11.6 Cleaning the airflow slots

Use a vacuum cleaner to remove fluff from the airflow slots.

12. TROUBLESHOOTING

Problem 1)	Possible cause	Remedy
The tumble dryer does not operate.	The tumble dryer is not connected to the mains supply.	Connect to the mains socket.
	The door is open.	Close the door.
	The On/Off button was not pushed.	Push the On/Off button.
	The Start/Pause button was not touched.	Touch the Start/Pause button.
	The appliance is in standby mode.	Push the On/Off button.
Unsatisfactory drying result.	Incorrect program selection.	Select a suitable program. 2)
	The filter is clogged.	Clean the filter. 3)
	Dryness option was set to  iron dry. 4)	Change Dryness option to higher level.
	The load was too large.	Do not exceed the maximum load size.
	The airflow slots are clogged.	Clean the airflow slots at the bottom of the appliance.
	Dirt on the humidity sensor in the drum.	Clean the front surface of the drum.
	Dryness level not set to desired level.	Adjust the dryness level. 5)
The condenser is clogged.	Clean the condenser. 3)	
The loading door does not close	The filter is not locked into position.	Put the filter in the correct position.
	Laundry is trapped between the door and the seal.	Remove trapped items and close the door.
Not possible to change the program or option.	After cycle start it is not possible to change the program or option.	Turn the tumble dryer off and on. Change the program or option as required.
Not possible to select an option. Acoustic signal is emitted.	The option you tried to select is not available for the selected program.	Turn the tumble dryer off and on. Change the program or option as required.
No drum light	Defective drum lamp.	Contact the service centre to replace the drum lamp.

Problem 1)	Possible cause	Remedy
Unexpected duration time on the display.	The drying duration is calculated according to load size and dampness.	This is automated — the appliance is working correctly.
Program inactive.	The water container is full.	Drain the water container, push the Start/Pause button. ³⁾
Drying cycle too short or stops without drying the load.	Load size is small.	Select time program. The time value must be related to the load. To dry 1 item or a small amount of laundry we recommend short drying times.
	The laundry is too dry.	Select time program or higher dryness level (e.g.  <i>extra dry</i>)
Drying cycle too long ⁶⁾	The filter is clogged.	Clean the filter.
	The load is too large.	Do not exceed the maximum load size.
	The laundry was not spun sufficiently.	Spin the laundry well.
	Too low or too high room temperature - this is not the appliance malfunction.	Ensure a room temperature higher than +5°C and lower than +35°C. Optimal room temperature to achieve best drying results is between 19°-24°C.

1) If there is an error message on the display (e.g. **E51**): Turn the tumble dryer off and on. Select a new program. Push the Start/Pause button. If the appliance does not operate contact the service centre and provide the error code.

2) Follow the program description — see PROGRAMS chapter

3) See chapter CARE AND CLEANING

4) Only dryers with Dryness option

5) See HINTS AND TIPS chapter

6) Note: After a maximum of 5 hours the drying cycle ends automatically.

13. TECHNICAL DATA

Height x Width x Depth	850 x 600 x 630 mm (maximal 640 mm)
Max. depth with the appliance door open	1100 mm
Max. width with the appliance door open	950 mm
Adjustable height	850 mm (+ 15 mm - feet regulation)
Drum volume	118 l

Maximum load volume	8 kg
Voltage	230-240 V
Frequency	50 Hz
Total power	900 W
Left—on mode power absorption	0,13 W
Off mode power absorption	0,13 W
Type of use	Household
Permitted ambient temperature	+ 5°C to + 35°C
Level of protection against ingress of solid particles and moisture ensured by the protective cover, except where the low voltage equipment has no protection against moisture	IPX4
This product contains fluorinated greenhouse gases, hermetically sealed	
Gas designation	R134a
Weight	0,300 kg
Global-warming potential (GWP)	1430

14. ACCESSORIES

14.1 Stacking kit

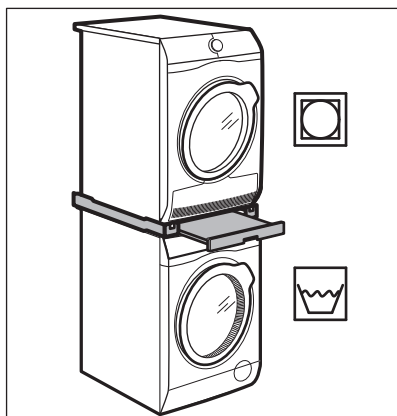

Accessory name: SKP11.

Available from your authorised vendor.

Stacking kit can be used only between washing machines and tumble dryers

specified in the leaflet. See the leaflet attached.

Read carefully the instructions supplied with the accessory.

14.2 Draining kit

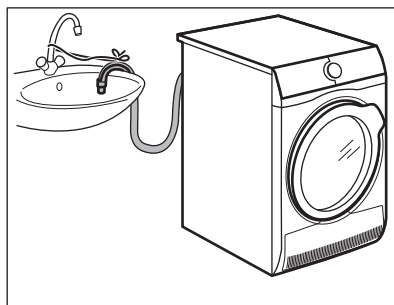

Accessory name: DK11.

Included with your AEG appliance.

For thorough draining of the condensed water into a basin, siphon, gully, etc.

After installation, the water container is drained automatically. The water container must stay in the appliance.

The installed hose must be minimum 50 cm to maximum 100 cm from floor level. The hose cannot be in a loop. Decrease the length of the hose if necessary.

Read carefully the instructions supplied with the accessory.

Available from your authorised vendor.

For increasing the height of the appliance in order to ease loading and unloading of laundry.

The drawer can be used for laundry storage e.g. towels, cleaning products etc.

Read carefully the instructions supplied with the accessory.

14.3 Pedestal with drawer

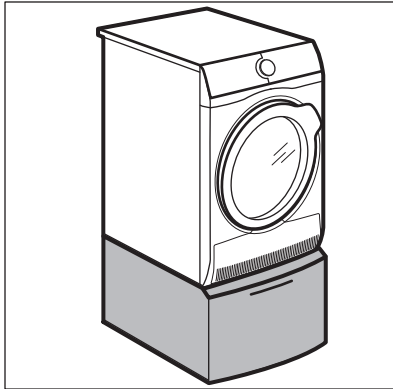

Accessory name: PDST60.

15. WARRANTY

FOR SALES IN AUSTRALIA AND NEW ZEALAND

ALL AEG BRANDED APPLIANCES

This document sets out the terms and conditions of the product warranties for AEG Appliances. It is an important document. Please keep it with your proof of purchase documents in a safe place for future reference should you require service for your Appliance.

1. In this warranty
 - a) 'acceptable quality' as referred to in clause 10 of this warranty has the same meaning referred to in the ACL;
 - b) 'ACL' means Schedule 2 to the Competition and Consumer Act 2010;
 - c) 'Appliance' means any AEG product purchased by you and accompanied by this document;
 - d) 'ASC' means AEG authorised service centres;
 - e) AEG is the brand controlled by Electrolux Home Products Pty Ltd of 163 O'Riordan Street, Mascot NSW 2020, ABN 51 004 762 341 in respect of Appliances purchased in Australia and Electrolux (NZ) Limited (collectively 'Electrolux') of 3-5 Niall Burgess Road, Mount Wellington, in respect of Appliances purchased in New Zealand;
 - f) 'major failure' as referred to in clause 10 of this warranty has the same meaning referred to in the ACL and includes a situation when an Appliance cannot be repaired or it is uneconomic for Electrolux, at its discretion, to repair an Appliance during the Warranty Period;

- g)** 'Warranty Period' means the Appliance is warranted against manufacturing defects in Australia and New Zealand for 60 months, following the date of original purchase of the Appliance;
- h)** 'you' means the purchaser of the Appliance not having purchased the Appliance for re-sale, and 'your' has a corresponding meaning.
2. This warranty only applies to Appliances purchased and used in Australia or New Zealand in normal domestic applications and is in addition to (and does not exclude, restrict, or modify in any way) any non-excludable statutory warranties in Australia or New Zealand.
 3. During the Warranty Period Electrolux or its ASC will, at no extra charge if your Appliance is readily accessible for service, without special equipment and subject to these terms and conditions, repair or replace any parts which it considers to be defective. Electrolux or its ASC may use remanufactured parts to repair your Appliance. You agree that any replaced Appliances or parts become the property of Electrolux. This warranty does not apply to light globes, batteries, filters or similar perishable parts.
 4. Parts and Appliances not supplied by Electrolux are not covered by this warranty.
 5. To the extent permitted by law, you will bear the cost of transportation, travel and delivery of the Appliance to and from Electrolux or its ASC. If you reside outside of the service area, you will bear the cost of:
 - a)** travel of an authorised representative;
 - b)** transportation and delivery of the Appliance to and from Electrolux or its ASC.

In all instances, unless the Appliance is transported by Electrolux or an AEG authorised representative, the Appliance is transported at the owner's cost and risk while in transit to and from Electrolux or its ASC.
 6. Proof of purchase is required before you can make a claim under this warranty.
 7. You may not make a claim under this warranty unless the defect claimed is due to faulty or defective parts or workmanship. Electrolux is not liable in the following situations (which are not exhaustive):
 - a)** the Appliance is damaged by:
 - accident
 - misuse or abuse, including failure to properly maintain or service
 - normal wear and tear
 - power surges, electrical storm damage or incorrect power supply
 - incomplete or improper installation
 - incorrect, improper or inappropriate operation
 - insect or vermin infestation
 - failure to comply with any additional instructions supplied with the Appliance;
 - b)** the Appliance is modified without authority from Electrolux in writing;
 - c)** the Appliance's serial number or warranty seal has been removed or defaced;
 - d)** the Appliance was serviced or repaired by anyone other than Electrolux, an authorised repairer or ASC.
 8. This warranty, the contract to which it relates and the relationship between you and Electrolux are governed by the law applicable where the Appliance was purchased. Where the Appliance was purchased in New Zealand for commercial purposes the Consumer Guarantee Act does not apply.
 9. To the extent permitted by law and subject to your non-excludable statutory rights and warranties, AEG excludes all warranties and liabilities (other than as contained in this document) including liability for any loss or damage whether direct or indirect arising from your purchase, use or non use of the Appliance.
 10. For AEG Appliances and services in Australia, the Appliances come with a

guarantee that cannot be excluded under the ACL. You are entitled to a replacement or refund for a major failure and for compensation for any other reasonably foreseeable loss or damage. You are also entitled to have the Appliance repaired or replaced if the Appliance fails to be of acceptable quality and the failure does not amount to a major failure. The benefits to you given by this warranty are in addition to your other rights and remedies under a law in relation to the Appliances or services to which the warranty relates.

11. At all times during the Warranty Period, Electrolux shall, at its discretion, determine whether repair, replacement or refund will apply if an Appliance has a valid warranty claim applicable to it.
12. For Appliances and services provided in New Zealand, the Appliances

come with a guarantee pursuant to the provisions of the Consumer Guarantees Act, the Sale of Goods Act and the Fair Trading Act.

13. To enquire about claiming under this warranty, please follow these steps:
 - a) carefully check the operating instructions, user manual and the terms of this warranty;
 - b) have the model and serial number of the Appliance available;
 - c) have the proof of purchase (e.g. an invoice) available;
 - d) telephone the numbers shown below.
14. You accept that if you make a warranty claim, Electrolux and its ASC may exchange information in relation to you to enable Electrolux to meet its obligations under this warranty.

Important Notice

Before calling for service, please ensure that the steps listed in clause 13 above have been followed.

AEG SERVICE AUSTRALIA

www.aeg.com/au

FOR SERVICE

or to find the address of your nearest state service centre in Australia

PLEASE CALL 1300 363 664

OR EMAIL customer care@aegaustralia.com.au

For the cost of a local call (Australia only)

FOR SPARE PARTS

or to find the address of your nearest state spare parts centre in Australia

PLEASE CALL 13 13 50

OR EMAIL customer care@aegaustralia.com.au

For the cost of a local call (Australia only)

AEG SERVICE NEW ZEALAND

www.aeg.co.nz

FOR SERVICE

or to find the address of your nearest authorised service centre in New Zealand

FREE CALL 0800 10 66 10

OR EMAIL customer care@electrolux.co.nz

(New Zealand only)

FOR SPARE PARTS

or to find the address of your nearest state spare parts centre in New Zealand

FREE CALL 0800 10 66 20

OR EMAIL customercare@electrolux.co.nz

(New Zealand only)

16. ENVIRONMENTAL CONCERNS

Recycle the materials with the symbol . Put the packaging in applicable containers to recycle it. Help protect the environment and human health and to recycle waste of electrical and electronic appliances. Do not dispose appliances

marked with the symbol  with the household waste. Return the product to your local recycling facility or contact your municipal office.

This document sets out the terms and conditions of the product warranties for AEG Appliances. It is an important document. Please keep it with your proof of purchase documents in a safe place for future reference should there be a manufacturing defect in your Appliance. This warranty is in addition to other rights you may have under the Australian Consumer Law.

1. In this warranty:

- (a) 'ACL' or 'Australian Consumer Law' means Schedule 2 to the Competition and Consumer Act 2010;
- (b) 'Appliance' means any Electrolux product purchased by you and accompanied by this document;
- (c) 'ASC' means Electrolux's authorised serviced centres;
- (d) 'AEG' is the brand controlled by Electrolux Home Products Pty Ltd of 163 O'Riordan Street, Mascot NSW 2020, ABN 51 004 762 341 in respect of Appliances purchased in Australia and Electrolux (NZ) Limited (collectively "Electrolux") of 3-5 Niall Burgess Road, Mount Wellington, in respect of Appliances purchased in New Zealand;
- (e) 'Warranty Period' means the period specified in clause 3 of this warranty;
- (f) 'you' means the purchaser of the Appliance not having purchased the Appliance for re-sale, and 'your' has a corresponding meaning.

2. Application: This warranty only applies to new Appliances, purchased and used in Australia or New Zealand and is in addition to (and does not exclude, restrict, or modify in any way) other rights and remedies under a law to which the Appliances or services relate, including any non-excludable statutory guarantees in Australia and New Zealand.

3. Warranty Period: Subject to these terms and conditions, this warranty continues for in Australia for a period of 60 months and in New Zealand for a period of 60 months, following the date of original purchase of the Appliance.

4. Repair or replace warranty: During the Warranty Period, Electrolux or its ASC will, at no extra charge if your Appliance is readily accessible for service, without special equipment and subject to these terms and conditions, repair or replace any parts which it considers to be defective. Electrolux may, in its absolute discretion, choose whether the remedy offered for a valid warranty claim is repair or replacement. Electrolux or its ASC may use refurbished parts to repair your Appliance. You agree that any replaced Appliances or parts become the property of Electrolux.

5. Travel and transportation costs: Subject to clause 7, Electrolux will bear the reasonable cost of transportation, travel and delivery of the Appliance to and from Electrolux or its ASC. Travel and transportation will be arranged by Electrolux as part of any valid warranty claim.

6. Proof of purchase is required before you can make a claim under this warranty.

7. Exclusions: You may not make a claim under this warranty unless the defect claimed is due to faulty or defective parts or workmanship. This warranty does not cover:

- (a) light globes, batteries, filters or similar perishable parts;
- (b) parts and Appliances not supplied by Electrolux;

- (c) cosmetic damage which does not affect the operation of the Appliance;
- (d) damage to the Appliance caused by:
 - (i) negligence or accident;
 - (ii) misuse or abuse, including failure to properly maintain or service;
 - (iii) improper, negligent or faulty servicing or repair works done by anyone other than an Electrolux authorised repairer or ASC;
 - (iv) normal wear and tear;
 - (v) power surges, electrical storm damage or incorrect power supply;
 - (vi) incomplete or improper installation;
 - (vii) incorrect, improper or inappropriate operation;
 - (viii) insect or vermin infestation;
 - (ix) failure to comply with any additional instructions supplied with the Appliance;

In addition, Electrolux is not liable under this warranty if:

- (a) the Appliance has been, or Electrolux reasonably believes that the Appliance has been, used for purposes other than those for which the Appliance was intended, including where the Appliance has been used for any non-domestic purpose;
- (b) the Appliance is modified without authority from Electrolux in writing;
- (c) the Appliance's serial number or warranty seal has been removed or defaced.

8. How to claim under this warranty: To enquire about claiming under this warranty, please follow these steps:

- (a) carefully check the operating instructions, user manual and the terms of this warranty;
- (b) have the model and serial number of the Appliance available;
- (c) have the proof of purchase (e.g. an invoice) available;
- (d) telephone the numbers shown below.

9. Australia: For Appliances and services provided by Electrolux in Australia: Electrolux goods come with guarantees that cannot be excluded under the Australian Consumer Law. You are entitled to a replacement or refund for a major failure and for compensation for any other reasonably foreseeable loss or damage. You are also entitled to have the Appliance repaired or replaced if the Appliance fails to be of acceptable quality and the failure does not amount to a major failure. 'Acceptable quality' and 'major failure' have the same meaning as referred to in the ACL.

10. New Zealand: For Appliances and services provided by Electrolux in New Zealand, the Appliances come with a guarantee by Electrolux pursuant to the provisions of the Consumer Guarantees Act, the Sale of Goods Act and the Fair Trading Act. Where the Appliance was purchased in New Zealand for commercial purposes the Consumer Guarantee Act does not apply.

11. Confidentiality: You accept that if you make a warranty claim, Electrolux and its agents including ASC may exchange information in relation to you to enable Electrolux to meet its obligations under this warranty.

Important Notice

Before calling for service, please ensure that the steps listed in clause 8 above have been followed.

<p>FOR SERVICE or to find the address of your nearest authorised service centre in Australia PLEASE CALL 1300 363 664 OR EMAIL customercare@aegaustralia.com.au For the cost of a local call (Australia only)</p>	<p>SERVICE AUSTRALIA  aeg.com/au</p>	<p>FOR SPARE PARTS or to find the address of your nearest spare parts centre in Australia PLEASE 13 13 50 OR EMAIL customercare@aegaustralia.com.au For the cost of a local call (Australia only)</p>
<p>FOR SERVICE or to find the address of your nearest authorised service centre in New Zealand PLEASE CALL 0800 234 234 OR EMAIL customercare@electrolux.co.nz (New Zealand only)</p>	<p>SERVICE NEW ZEALAND  aegnewzealand.co.nz</p>	<p>FOR SPARE PARTS or to find the address of your nearest spare parts centre in New Zealand PLEASE 0800 10 66 20 OR EMAIL customercare@electrolux.co.nz (New Zealand only)</p>

www.aeg.com/au

136946980-B-122017



AEG