



LF9516O8QS

EN User Manual | **Washing Machine**



Welcome to AEG! Thank you for choosing our appliance.



In our drive to be sustainable, we are reducing paper assets and provide full user manuals online. Access your full user manual at aeg.com/manuals



Get usage advice, brochures, troubleshooting, service and repair information at aeg.com/support



Buy accessories, consumables, and original spare parts for your appliance at aeg.com/shop

Subject to change without notice.

CONTENTS

1. SAFETY INFORMATION.....	2
2. SAFETY INSTRUCTIONS.....	4
3. PRODUCT DESCRIPTION.....	6
4. TECHNICAL DATA.....	7
5. INSTALLATION.....	7
6. CONTROL PANEL.....	13
7. DIAL AND BUTTONS.....	16
8. SETTINGS.....	19
9. BEFORE FIRST USE.....	20
10. THE AUTODOSE TECHNOLOGY (AUTODOSING).....	21
11. PROGRAMS	28
12.  WI-FI - CONNECTIVITY SETUP.....	33
13. DAILY USE.....	36
14. CARE AND CLEANING.....	40
15. TROUBLESHOOTING.....	48
16. QUICK GUIDE.....	52
17. ENVIRONMENTAL CONCERNS.....	56

1. SAFETY INFORMATION



Before beginning the installation and use of this appliance, carefully read the supplied instructions. The manufacturer is not responsible for any injuries or damage that are the result of incorrect installation or usage. Always keep the instructions in a safe and accessible location for future reference.

1.1 Children and vulnerable people safety

- Children should be supervised to ensure that they do not play with the appliance.

- Keep all packaging away from children and dispose of it appropriately.
- Keep detergents away from children.
- Keep children and pets away from the appliance when the door is open.
- If the appliance has a child safety device, it should be activated.
- Children shall not carry out cleaning and user maintenance of the appliance without supervision.

1.2 General Safety

- This appliance is for washing domestic-type, machine-washable laundry only.
- This appliance is designed for single household domestic use in an indoor environment.
- This appliance may be used in offices, hotel guest rooms, bed & breakfast guest rooms, farm guest houses and other similar accommodation where such use does not exceed (average) domestic usage levels.
- Do not change the specification of this appliance.
- The appliance maximum load is 10.0 kg. Do not exceed the maximum load of each programme (refer to the “Programmes” chapter).
- The operating water pressure at the water entry point from the outlet connection must be between 0.5 bar (0.05 MPa) and 10 bar (1.0 MPa).
- The ventilation opening in the base must not be covered by a carpet, mat, or any floor covering.
- The appliance must be connected to the water mains using the new supplied hose sets, or other new hose sets supplied by the Authorised Service Centre.
- Old hose sets must not be reused.
- If the mains power supply cable is damaged, it must be replaced by the manufacturer, its Authorised Service Centre or similarly qualified persons to avoid an electrical hazard.

- Before any maintenance operation, deactivate the appliance and disconnect the mains plug from the socket.
- Do not use high pressure water sprays and/or steam to clean the appliance.
- Clean the appliance with a moist cloth. Use only neutral detergents. Do not use abrasive products, abrasive cleaning pads, solvents or metal objects.

2. SAFETY INSTRUCTIONS

2.1 Installation



The installation must comply with relevant national regulations.

- Remove all the packaging and the transit bolts.
- Keep the transit bolts in a safe place. If the appliance is to be moved in the future they must be reattached to lock the drum to prevent an internal damage.
- Always take care when moving the appliance as it is heavy. Always use safety gloves and enclosed footwear.
- Follow the installation instructions supplied with the appliance.
- Do not install or use a damaged appliance.
- Do not install or use the appliance where the temperature can be less than 0°C or where it is exposed to the weather.
- The floor area on which the appliance is to be installed must be flat, stable, heat resistant and clean.
- Make sure that there is air circulation between the appliance and the floor.
- Do not install the appliance directly above a floor drain.
- Adjust the feet to have the necessary space between the appliance and the flooring.
- Do not install the appliance where the appliance door cannot be fully opened.
- Do not put a container to collect possible water leakage under the appliance. Contact the Authorised Service Centre to ensure which accessories can be used.

2.2 Electrical connection



WARNING!

Risk of fire and electric shock.

- **WARNING:** This appliance is designed to be installed / connected to a grounding connection in the building.
- Always use a correctly installed shockproof socket.
- Make sure that the parameters on the rating plate are compatible with the electrical ratings of the mains power supply.
- Do not use multi-plug adapters and extension cables.
- Make sure not to cause damage to the mains plug and to the mains cable. Should the mains cable need to be replaced, this must be carried out by our Authorised Service Centre.
- Connect the mains plug to the mains socket only at the end of the installation. Make sure that there is access to the mains plug after the installation.
- Do not touch the mains cable or the mains plug with wet hands.
- Do not pull the mains cable to disconnect the appliance. Always pull the mains plug.

2.3 Water connection

- The inlet water shall not exceed 25 °C.
- Do not cause damage to the water hoses.
- Before connection to new pipes, pipes not used for a long time, where repair work has been carried out or new devices fitted (water meters, etc.), let the water flow until it is clean and clear.

- Ensure that there are no visible water leaks during and after the first use of the appliance.
- Do not use an extension hose if the inlet hose is too short. Contact the Authorised Service Centre for the replacement of the inlet hose.
- When unpacking the appliance, It is possible to see water flowing from the drain hose. This is due to the testing of the appliance with the use of water in the factory.
- You can extend the drain hose to maximum 400 cm. Contact the Authorised Service Centre for the other drain hose and the extension.
- Make sure that there is access to the tap after the installation.

2.4 Use

WARNING!

Risk of injury, electric shock, fire, burns or damage to the appliance.

- Follow the safety instructions on the detergent packaging.
- Do not put flammable products or items that are wet with flammable products in, near or on the appliance.
- Do not wash fabrics which are heavily soiled with oil, grease or other greasy substances. It can damage rubber parts of the appliance. Prewash such fabrics by hand before loading them into the appliance.
- Do not use laundry fragrances to avoid the risk of damaging plastic and rubber parts of the appliance.
- Do not touch the glass door while a programme operates. The glass can get hot.
- Make sure that all metal objects are removed from the laundry.

2.5 Internal lighting

WARNING!

Risk of injury.

- Visible LED radiation, do not look directly into the beam.
- To replace the internal lighting, contact the Authorised Service Centre.

2.6 Service

- To repair the appliance contact the Authorised Service Centre. Use original spare parts only.
- Please note that self-repair or non-professional repair can have safety consequences and might void the guarantee.
- Concerning the lamp(s) inside this product and spare part lamps sold separately: These lamps are intended to withstand extreme physical conditions in household appliances, such as temperature, vibration, humidity, or are intended to signal information about the operational status of the appliance. They are not intended to be used in other applications and are not suitable for household room illumination.

2.7 Disposal

WARNING!

Risk of injury or suffocation.

- Disconnect the appliance from the mains electrical and water supplies.
- Cut off the mains electrical cable close to the appliance and dispose of it.
- Remove the door catch to prevent children or pets from becoming trapped in the drum.
- Dispose of the appliance in accordance with local requirements for the disposal of Waste Electrical and Electronic Equipment (WEEE).

3. PRODUCT DESCRIPTION

3.1 Special features

Your new washing machine meets all modern requirements for an effective treatment of laundry with low water, energy and detergent consumption and proper care of fabric.

- The **Wi-Fi connection** and **Remote Start** enable you to start a cycle, to interact with your washing machine and to check the washing cycle status in remote control.
- The **PowerCare technology** has been designed to protect the fabric fibres thanks to different pre-mixing phases that dissolves first the detergent and then fabric softener in the water before they are distributed in the laundry. So every fibre is reached and cared for.
- The **ProSense technology** detects the laundry load size defining the program duration in 30 seconds. The washing program is tailored to the laundry load and the type of fabric without consuming more time, energy and water than necessary.

- The steam has a quick and easy way to refresh the clothes. The gentle steam programs remove odours and reduce creases in dry fabrics so they need little ironing. The **Plus Steam option**, finishes every cycle with gentle steam that relaxes the fibres and reduces fabric creasing. Ironing will be easier!
- The **Stains option** pre-treats stubborn stains optimizing the effectiveness of the stain remover.
- The **AutoDose technology** automatically dispenses the right amount of detergent according to the load; the drawer has two integrated tanks (detergent + softener or second detergent type) and two additional chambers for detergent and additives manual load. It gives the highest use flexibility.

3.2 Appliance overview

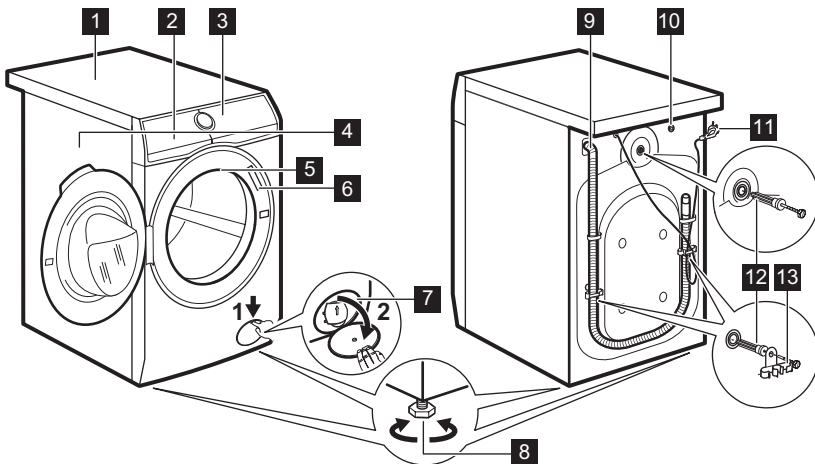

- 1 Worktop
- 2 Detergent dispenser with AutoDose tanks and manual compartments

- 3 Control panel
- 4 Door handle
- 5 Internal light

- 6 Rating plate
- 7 Drain pump filter
- 8 Feet for levelling the appliance
- 9 Drain hose
- 10 Inlet hose connection

- 11 Mains cable
- 12 Transit bolts
- 13 Hose support

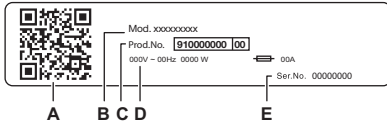

The rating plate reports:

- A. QR code
- B. Model name
- C. Product number
- D. Electrical ratings
- E. Serial number

Scan the **QR code** with the camera to download our App from the app store on your smart device and follow the required steps. Register your product and get the most out of it.

- Access your appliance details, documentation and articles on how to use the best features (User Manual also available at aeg.com/manuals)
- Get usage advice, troubleshooting, service and repair information (also available at aeg.com/support)
- Buy accessories, Consumable and Original Spare parts for your appliance (also available at aeg.com/shop)

4. TECHNICAL DATA

Dimension	Width/ Height/ Total depth	59.7 cm /84.7 cm /66.0 cm
Electrical connection	Voltage Overall power Fuse Frequency	220 - 240 V 2100 W 10 A 50 Hz
Level of protection against ingress of solid particles and moisture ensured by the protective cover, except where the low voltage equipment has no protection against moisture		IPX4
Water supply pressure	Minimum Maximum	0.5 bar (0.05 MPa) 10 bar (1.0 MPa)
Water supply ¹⁾		Cold water
Maximum Load	Cotton	10.0 kg

1) Connect the water inlet hose to a water tap with a 3/4" thread.

5. INSTALLATION

WARNING!

Refer to Safety chapters.

5.1 Unpacking

⚠ WARNING!

Remove all the packaging and the transit bolts before installing the appliance.

⚠ WARNING!

Use the gloves.

1. Remove the external film. If necessary, use a cutter.

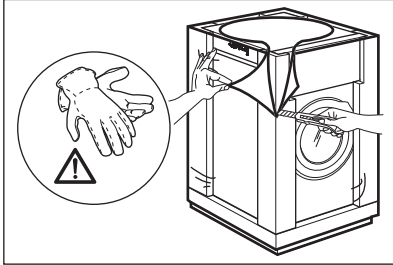

2. Remove the cardboard top and the other packaging materials.

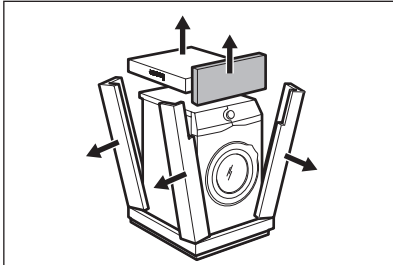

3. Remove the internal film.

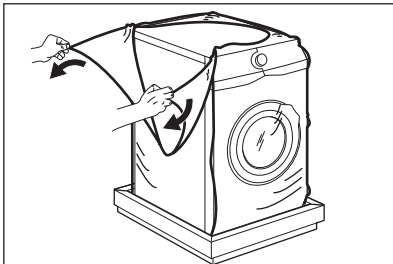

4. Open the door, remove the piece from the door seal and all the items from the drum.

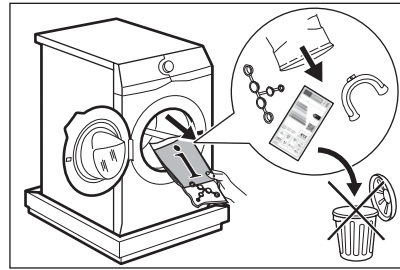

5. Carefully put the appliance down on its rear side.
6. Put the front packaging element on the floor under the appliance.

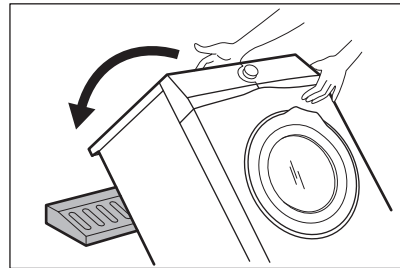

Make sure not to damage the hoses.

7. Remove the protection from the bottom.

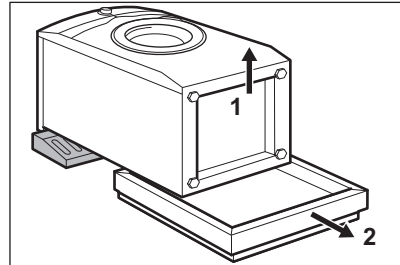

8. Fully clean and dry the bottom of the appliance.

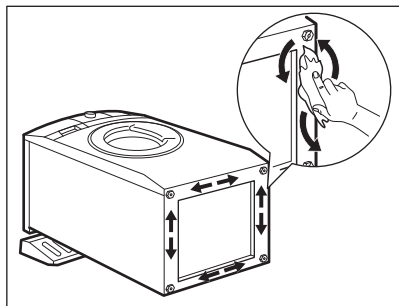

⚠ CAUTION!

Do not use alcohol, solvents or chemical products.

9. Make sure to identify the different sizes and the positions of the sound barriers. Refer to the illustration:

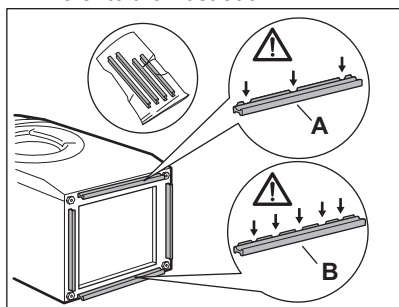

- **A (FRONT)** = Front of the appliance
- **B (BACK)** = Rear of the appliance

10. Remove the adhesive strip from the silent barriers.
11. Attach the four barriers to bottom of the appliance.
12. Refer to the illustration. Make sure that the barriers are securely attached.

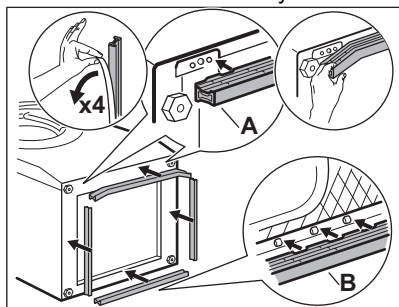

i

Attach the sound barriers at a room temperature.

13. Pull up the appliance in vertical position.

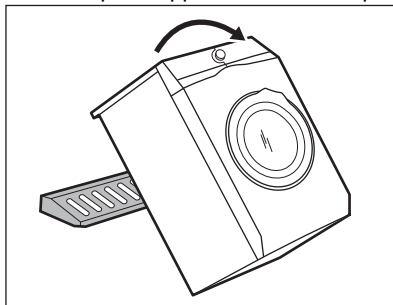

14. Remove the power supply cable and the drain hose from the hose holders.

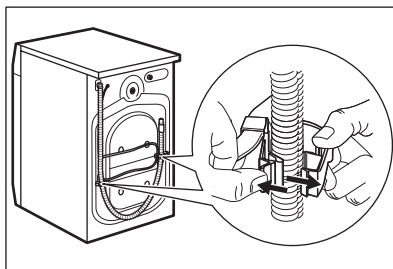

i

It is possible to see water flowing from the drain hose. This is due to the testing with water of the appliance in factory.

15. Remove the three bolts by using the spanner supplied with the appliance.

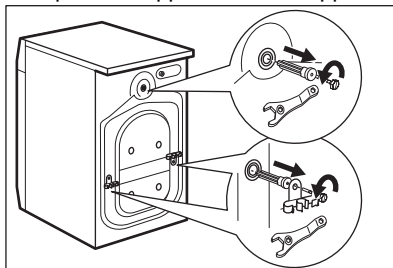

16. Pull out the plastic spacers.
17. Put the plastic caps, that you find in the user manual bag, in the holes.

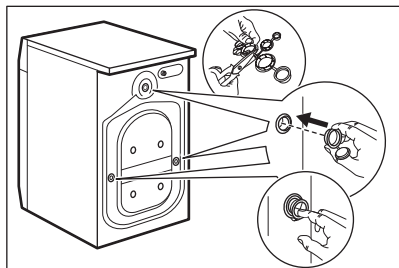

We recommend that you keep the packaging and the transit bolts for any movement of the appliance.

5.2 Positioning and levelling

1. Install the appliance on a flat hard floor.



Make sure that the appliance does not touch the wall or other units.

2. Loosen or tighten the feet to adjust the level.

⚠ WARNING!

Do not put cardboard, wood or equivalent materials below the appliance feet to adjust the level.

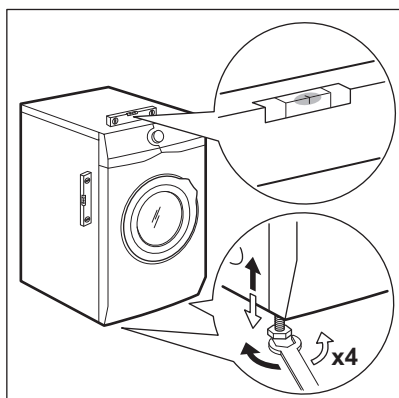

The appliance must be level and stable.



A correct adjustment of the appliance level prevents the vibration, noise and the movement of the appliance when in operation.



When the appliance is installed on a plinth or a tumble dryer is stacked on the washing machine, use the accessories described in chapter 'Accessories'. Read carefully the instructions supplied with the appliance and with the accessory.

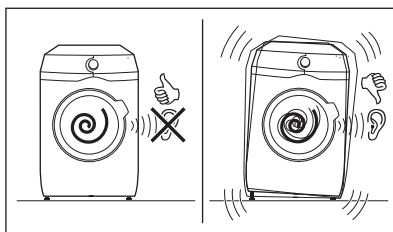

5.3 The inlet hose

1. Connect the water inlet hose to the back of the appliance.
2. Position it toward left or right depending on the position of the water tap.

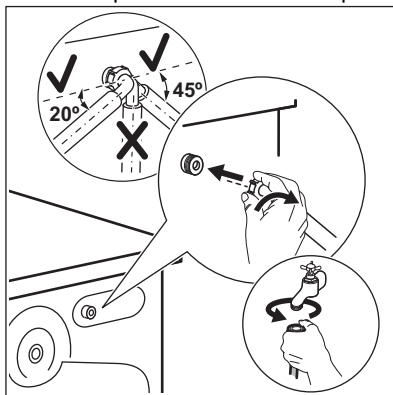

Make sure that the inlet hose is not in vertical position.

3. If necessary, loose the ring nut to set it in the correct position.

4. Connect the water inlet hose to the cold water tap with 3/4" thread.

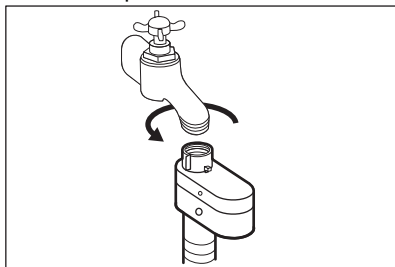

⚠ WARNING!

The inlet water shall not exceed 25 °C.

⚠ CAUTION!

Make sure that there are no leaks from the couplings.



Do not use an extension hose if the inlet hose is too short. Contact the service centre for information on inlet hose replacement.

5.4 Water-stop device

The inlet hose has a water stop device. This device prevents water leaks in the hose because of its natural ageing.

The red sector in the window «A» shows this fault.

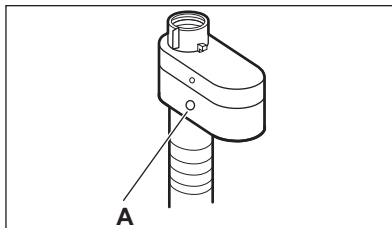

If this occurs, close the water tap and contact the authorized service centre to replace the hose.

5.5 Water drainage

The drain hose should be positioned at a height of not less than 60 cm and not more than 100 cm from the floor.



You can extend the drain hose to maximum 400 cm. Contact the authorized service centre to buy the other drain hose and the extension.

It is possible to connect the drain hose in different ways:

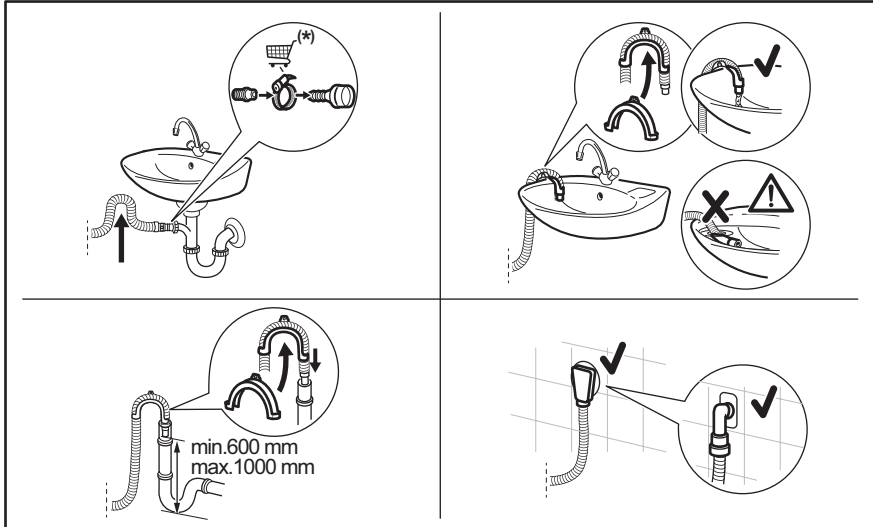

(*) Subject to change without notice.

- Connect the drain hose to the spigot and tighten it with a clamp.
- Position the hose directly to a built-in drain pipe in the room wall and tighten it with a clamp.
- Without the plastic hose guide, to a sink spigot - remove the plastic membrane from the sink trap spigot.
- To a stand pipe with vent hole - insert the drain hose directly into a drain pipe or stand pipe.
- The drain hose can be bent into U shape and put around the plastic guide. On the edge of a sink - fasten the guide to the water tap or to the wall.



Make sure that the drain hose makes a loop to prevent particles going into the appliance from the sink.



Make sure that the plastic guide cannot move when the appliance drains and the drain hose end is not immersed in the water. There may be a return of dirty water into the appliance.



The end of the drain hose must always be ventilated, i.e. the inner diameter of the drain pipe (min. 38 mm - min. 1.5") must be larger than the external diameter of the drain hose.

5.6 Electrical connection

At the end of installation you can connect the mains plug to the mains socket.

The rating plate and the 'Technical Data' chapter indicate the necessary electrical ratings. Make sure that they are compatible with the mains power supply.

Check that your domestic electrical installation can take the maximum load required, also taking into account any other appliances in use.

Connect the appliance to an earthed socket.

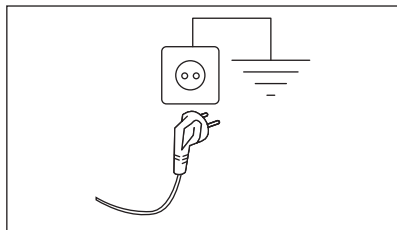

The power supply cable must be easily accessible after installing the appliance.

For any electrical work required to install this appliance, contact our Authorised Service Centre.

The manufacturer does not accept any responsibility for damage or injury through failure to comply with the above safety precaution.

6. CONTROL PANEL

6.1 Control panel description

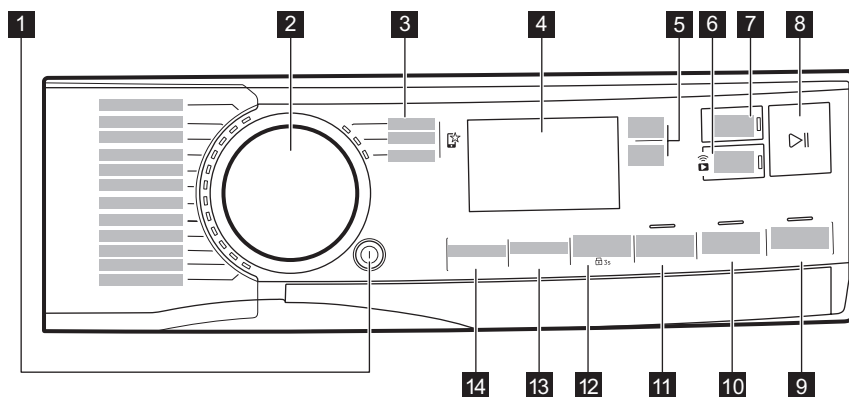

The options are not selectable with all washing programs. Check the compatibility between options and washing programs in the "Options compatibility with programs" paragraph in the "Programs" chapter. An option can exclude another one, in this case the appliance doesn't allow you to set the incompatible options together.

Make sure the screen and touch buttons are always clean and dry.

- 1 On/Off push button
- 2 Program dial
- 3 Favourite programs
- 4 Display
- 5 AutoDose Liquid Detergent and Fabric Softener touch buttons
- 6 Wi-fi connection and Remote Start touch button
- 7 Finish In touch button
- 8 Start/Pause touch button
- 9 Confirm Start touch button
- 10 Extra Rinse touch button
- 11 Time Save touch button and Plus Steam option

12 Stains/Prewash touch button and permanent Child Lock option 3s

13 Spin touch button

14 Temperature touch button

6.2 Display

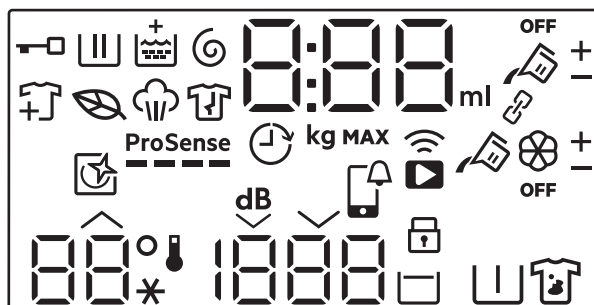

	Door locked indicator.
	Washing phase indicator. It flashes during pre-wash and wash phase.
	Rinsing phase indicator. It flashes during rinse phase.
	Spinning and draining phase indicator. It flashes during spin and drain phase.
	Steam phase indicator.
	Anti-crease phase indicator.
	Leaf Icon turns on to indicate when the cycles and options selected have a low energy consumption profile.
	Add garments indicator: it lights on when the programme starts and the user can still pause the appliance and add more laundry.
	Extra Rinse indicator.
ProSense 	ProSense indicator.
	Finish In indicator.

0:00

The digital indicator can show:

- Programme duration (e. g. 2:40).



The time shown when the programme is set could not correspond to effective duration and change after ProSense phase.

- Maximum load.
- Finish in time (e. g. 30' or 2h).
- Cycle end (□).
- Warning code (e.g. E20).
- Liquid detergents and softener quantity indicator: 88^{ml}. Refer to "The AutoDose technology (Autodosing)" chapter.
- Indication of total operating hours of the appliance. Refer to the 'Operating hours counter' section in the 'Settings' paragraph for more details.
- When working with the APP: APP AP (access point), UPd (update). Please refer to the chapter 'Wi-Fi - Connectivity setup'.

888

Maximum load indicator. The value is shown for three seconds after programme selection, alternated with cycle duration.

MAX

Maximum laundry indicator. It blinks if the laundry amount exceeds the declared load.



AutoDose liquid detergent tank indicator. When it lights, appliance automatically doses the detergent.



These indicators will appear next to and when increasing or decreasing the automatic detergent or softener dosage.

OFF

AutoDose status indicator. It lights when AutoDose function for additives is disable.



These indicators appears when setting the automatic detergent or softener dosage. (refer to "The AutoDose technology (Autodosing)" chapter)



This indicator reminds to run a cleaning cycle.



APP notification to check.



Remote connection indicator.
Wi-Fi connection indicator.



Child safety lock indicator.

88°
--*

The Temperature area:
Temperature indicator
Cold water indicator

1888

The spin area:
Spin speed indicator
No Spin indicator. Spin phase is off.









--



Extra Silent indicator.



Rinse hold indicator.

	Pre-wash indicator.
	Stain indicator.
Indicators for options downloadable via App only	
	Linked mode indicator. It lights when both AutoDose tanks are linked and filled with the same detergent. AutoDose function for softener is disable: the indicator  disappears and the display shows two liquid detergent tank indicators  . Access the app to activate this mode.
	These indicators will appear next to  and  when increasing or decreasing the automatic detergent or softener dosage. Access the app to activate this mode.

7. DIAL AND BUTTONS

7.1 On/Off

Pressing this button for a few seconds allows to activate or deactivate the appliance. Two different tunes sound while switching the appliance on or off.

As the Stand-by function automatically deactivates the appliance to decrease the energy consumption in a few cases, you may need to activate the appliance again.

For more details, refer to Stand-by paragraph in Daily Use chapter.

7.2 Program dial

By rotating the program dial it is possible to select the desired program.

7.3 Favourite programs

These selector positions are available after the appliance have been connected to Wi-Fi.

The favourite programs can be set and saved via App only choosing from the available ones which are divided into the three categories indicated on the control panel.

Once the favourite programs have been set, you can select one of them via App or by turning the program dial to relevant position: the relevant led comes on and the information on the display are updated accordingly.



The favourite programs can be cancelled through the related App command or pressing the Factory Default key combination.



7.4 Introduction



The options/functions are not selectable with all washing programs. Check the compatibility between options/functions and washing programs in the "Program Chart". An option/function can exclude another one, in this case the appliance doesn't allow you to set the incompatible options/functions together. Make sure the screen and touch buttons are always clean and dry.

7.5 AutoDose Liquid Detergent and Fabric Softener

By means of this buttons you can:

- : activate and deactivate the automatic detergent loading.
- : activate and deactivate the automatic fabric softener loading.



Refer to "The AutoDose Technology (Autodosing)" chapter for more details.

7.6 Remote start

To activate the Remote Start function, press the button. Confirm LED starts blinking until **Confirm Start** button is pressed.

Remote Start function allows you to start, pause and stop the appliance remotely.

The related led comes on and the related icon appears on display.



If you set a program via App and it does not match with the knob position, **APP** text appears alternating with program duration.

Press and hold this button for longer time to provide two other functions:

- hold it down for 3 seconds as long as a click sounds: the Wi-Fi is turned on and off.
- hold it down for 10 seconds as long as a double beep sounds and **---** appears on the display: to reset the Network Credentials.

7.7 Finish In



Set this option as last after program and other options selection, otherwise it can be cancelled if you change some setting.

This option allows choosing the time within which a program should terminate. The program end can be postponed by one 1 hour every button touch until 24 hours maximum.

The display shows the normal program duration alternatively with the set program end time (expressed in hours 0h). The minimum selectable time corresponds to rounded up hour of the maximum duration of a program (e.g. if the cycle duration lasts 3:15 hours, the minimum selectable time will be 4h).

After program start, the door is locked and the appliance starts the ProSense phase. When load estimation ends, on the display the icon of running phase blinks and the time

digit counts down in steps of one hour and in steps of 1 minute during the last hour.

7.8 Confirm Start

Confirm Start is a two-step activation feature for the appliance. It ensures that the user intentionally starts the program.

This helps prevent accidental starts and ensures the selected setting are correct before the appliance begins program.



If the Confirm Start touch button is not pressed within 10 seconds time period, the appliance will automatically exit the activation state.



This two-step start mechanism is a part of the AS/NZS 60335.2.7 safety standard. Always supervise children around appliances.

7.9 Start/Pause

Touch the Start/Pause  button to start, pause the appliance or interrupt a running program.



When the Start/Pause button is pressed, Confirm LED starts blinking until **Confirm Start** button is pressed.

7.10 Extra Rinse

With this option you can add a few rinses to the selected washing programs and optimise the fabric softener distribution and improve the fabric softness.

It is suggested when you use the fabric softener.

Useful for people allergic to detergents and in areas where the water is soft.

This option increases the program duration.

The button indicator comes on.

7.11 Time Save

With this option you can decrease the program duration.

- If your laundry is normally or lightly soiled, it may be advisable to shorten the washing program. Touch this button **once** to decrease the duration.
- In case of smaller load, touch this button **twice** to set an extra quick program. In this case, the temperature 95°C is not selectable.

The led of the button is on and the display shows the set program duration.





This option can also be used to shorten the steam program duration.

7.12 Stains/Prewash

Press this button repeatedly to activate one of the two options or both.

The relevant indicator comes on in the display.

Stains

By setting this option, the indicator  appears close to detergent symbol , and the appliance will automatically dose an extra amount of detergent when automatic detergent tank is enabled. If automatic detergent tank is Off, it is possible to run this option as in traditional appliance by filling detergent or additive in the manual compartment.



If you press detergent tank button while Stains option is active, AutoDose function is switched off, but Stains option still remains active in manual mode.

Prewash

Use this option to add a pre-wash phase at 30 °C before the washing phase. This option is recommended for heavily soiled laundry, especially if containing sand, dust, mud and other solid particles.



When selecting a pre-wash phase and AutoDose is active, the appliance will automatically dose the detergent. When AutoDose is switched off, put the detergent/additive in a dosing ball inside the drum.



The options can increase the program duration.

7.13 Spin



When you set a program, the appliance automatically selects the default spin speed.

Touch this button repeatedly to:

- **Change the spin speed.**



The display shows only the spin speeds available for the set program.

- **Activate the Rinse Hold option .**
The water of the last rinse is not drained out to prevent the fabrics from creasing. The washing program ends with water in the drum and the final spin phase is not performed.
The display shows the indicator .
The drum turns regularly to reduce creasing.
The door stays locked. The drum turns regularly to reduce creasing. You must drain the water to unlock the door.
Touch Start/Pause button : the appliance performs the spinning phase and drains the water.
- **Activate the Extra silent option.**
All spinning phases (intermediate spin and final spin) are suppressed and the program ends with water in the drum. This helps to reduce creasing.
As the program is very quiet, it is suitable for use at night time when cheaper electricity tariffs are available. In some programs the rinses are performed with more water.
The display shows the indicator .
The door stays locked. The drum turns regularly to reduce creasing. You must drain the water to unlock the door.

Touch the Start/Pause button: the appliance performs only the draining phase.

- **No Spin** — — —. Set this option to deactivate all spin phases. The display shows the indicator — — —. The appliance performs the only draining phase of the selected washing program. Set this option for very delicate fabrics. The rinses phase uses more water for some washing programs



The appliance empties the water out automatically after approximately 18 hours.

7.14 Temperature

When you select a washing program, the appliance automatically proposes a default temperature.

Touch this button repeatedly until the desired temperature value appears on the display.

When the display shows the indicators ✱ and — —, the appliance does not heat the water.

8. SETTINGS

8.1 Introduction



When pressing a key combination, **do not tilt** your fingers downwards. The sensors of the underneath buttons are sensitive and may interfere with your choice.

8.2 Acoustic signals

This appliance is provided with different acoustic signals, that operate when:

- You activate the appliance (special short tune).
- You deactivate the appliance (special short tune).
- You touch the buttons (click sound).
- You make a wrong selection (3 short sounds).
- The program is completed (sequence of sounds for about 2 minutes).
- The appliance has a malfunction (sequence of short sounds for about 5 minutes).
- When a laundry overload is detected during ProSense phase (a double sound played one).

To **activate/deactivate** this option, hold down the Extra Rinse button until a beep or a double beep sounds.



If you deactivate this function, the acoustic signals stops playing at the end of the program only.

8.3 Child Lock

With this option you can prevent children from playing with the control panel.

To **activate/deactivate** this option, hold down the Stains/Prewash button until **☐ comes on/goes off** on the display.

The appliance will default to this option after you switch it off.

8.4 Plus Steam

By pressing the Time Save button for 3 seconds, enables the Plus Steam option

This option adds a steam phase followed by a short anti-crease phase at the end of the washing program.

The steam phase reduces fabric creasing and facilitates the fabric ironing.

The Plus Steam option achieves good results with a small load because steam better penetrates the laundry if there is more space. For this reason, the program maximum load



combined with this option is 2 kg (approximately 8 - 10 shirts).



When setting the Plus Steam option, the maximum load drops to 2 kg in the display and program time is adjusted accordingly.

The indicator  blinks in the display during steam phase.



This option can affect the program duration.

When the program stops the display shows a zero , the indicator  is steady on.

The anti-crease phase starts, the indicator  is blinking, and the  led remains lit. The drum performs smooth movements for about 30 minutes to keep the steam benefit.

To interrupt the anti-crease phase, you can:

- Press the On/Off  button for a few seconds to activate or deactivate the appliance.
- Turning the program dial in another position.

When the anti-crease movements stop and the door unlocks, the appliance proposes again the previous set program.





A small laundry load helps to reach better results.

8.5 Operating Hours Counter

It is possible to visualise the total operating time of the appliance in hours, starting from

the first switching on. This value will count operating time of the cycles (does not include pauses, delayed start time). To visualise this value, proceed as follows:

1. Switch the appliance on by pressing the On/Off  button.
2. Press and hold the Extra Rinse and Plus Steam buttons for some seconds.
3. After 3 seconds the total hours operated by the appliance are shown in the display: e.g. 1276 hours, the display shows the text Hr for 2 seconds, 12 (thousands and hundreds) for 2 seconds and 76 (tens and units).
4. To exit this mode, press any button or switch the appliance off by means of the On/Off  button.



If the procedure does not work (due to timeout or wrong keys combination), switch the appliance off and repeat sequence from the beginning.

8.6 Factory Defaults



This function allows to restore the factory default options. To **activate** this option follow steps below:

1. Switch the appliance on by pressing On/Off  button.
2. Press and hold the Stains/Prewash and Time Save buttons for some seconds.
3. The display will show -- -- for about 5 seconds.

9. BEFORE FIRST USE



During installation or before first use you may observe some water in the appliance. This is a residual water left in the appliance after a full functional test in the factory to ensure the appliance is delivered to customers in perfect working order and is no cause for concern.

1. Make sure that all transit bolts have been removed from the appliance.
2. Make sure that the electrical power is available and the water tap is open.
3. Make sure to fill the AutoDose tanks with liquid detergent  and fabric softener . Refer to "AutoDose basic setting" paragraph in "The AutoDose technology" chapter.

4. Pour 2 litres of water inside the drum.
This action activates the drain system.

5. Set and start a program for cotton at the highest temperature without any detergent and laundry in the drum.

10. THE AUTODOSE TECHNOLOGY (AUTODOSING)



Read this chapter carefully.

10.1 Introduction

Right detergent and fabric softener dosage takes better care of the laundry and ensuring good wash performances.

Too much detergent damages your clothes and too little doesn't ensure good wash performances.

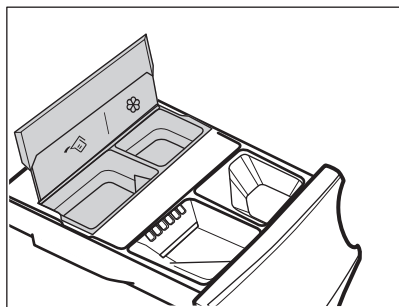

This appliance is equipped with an auto dosing system able to automatically provide the right detergent and fabric softener dosage to preserve the fabric integrity and colour brightness.





 AutoDose liquid detergent tank.

 AutoDose fabric softener tank.

The appliance is pre-set by the factory to suit most users habits.

Once started the program, the appliance will automatically release the right amount of detergent and softener according to the real fabric load, if AutoDose is activated and the indicators  and/or  are visible on the display.



In some programs, AutoDose is deactivated (the indicators  and/or  are not displayed and the display shows **OFF**) because there are garments requiring special detergents or treatments. If this is the case, pour the detergent and other treatments in the proper manual filling compartment. Please refer to "AutoDose and options compatibility with programs" in "Programs" chapter.



Further explanations on AutoDose and activation of advanced settings are available downloading the APP.

10.2 Detergent dispenser with AutoDose tanks and manual compartments



When using detergent and any other treatments, always follow the instructions that you find on the packaging of the detergent products. We recommend not to exceed the maximum indicated level in each compartment (**MAX**).

If both AutoDose tanks are enabled in the set program , liquid detergent and fabric softener are automatically loaded.

If one of the AutoDose tank or both are disabled (OFF) in the set program , proceed by manually filling in the proper manual compartment.

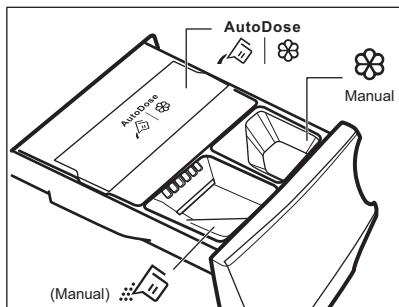

- AutoDose tanks for **liquid detergent**, and **fabric softener** .

WARNING!

Do not put powder detergent in the AutoDose compartment.

- Manual compartment for washing phase: **powder or liquid detergent**.

i

When using liquid detergent, make sure that the **special container for liquid detergent** is inserted. Refer to the "Manual filling the detergent and additives" paragraph in this chapter. The liquid detergent container is supplied inside the drum.

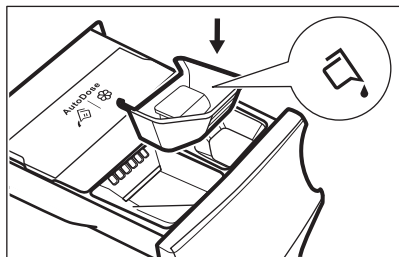

- Manual compartment for **liquid additives** (fabric softener, fabric conditioner, starch).
- **MAX** Maximum level for detergent/additives quantity.

10.3 AutoDose basic setting

The factory pre-set doses for a large load are 90 ml for detergent tank and 25 ml for fabric softener tank: the optimal configuration to meet majority of use condition. The appliance will use these settings to calculate the precise dosage for each wash based on load size.

However, under extreme conditions (very soft or very hard water) and particular type of detergent (such as super compact), we recommend to adjust the pre-set dosage by following the indication given on detergent and fabric softener container: e.g when using super compact detergent you may need to reduce the pre-set dosage considerably.

If the washing results are not satisfying or there is too much foam during washing, you may need to change the factory setting. Read in the paragraph 'AutoDose configuration mode' how to change the basic setting, but before:

1. Identify the water hardness level.

Check the water hardness level in your area. The levels are generally indicated as: soft, medium and hard.

If necessary, please contact your local water authority to check the water hardness in your area.

2. Identify the customized detergent dosage.

Check the label in the detergent/fabric softener container and identify the quantity to use. For the detergent the suggested quantity of detergent is the combination of three different factors:

- Water hardness level (see the following table);
- Normal soil level;
- Rated capacity of the appliance (e.g. maximum load capacity 10.0 kg). If the rated capacity on the detergent container label refers to lower capacity appliances, the customized dosage should be increased by 20% referring to the proposed dosage.



As example for a machine with rated capacity 8 kg, medium water, normal soil level the dosage is recognised by the crossing in the detergent label dosages.

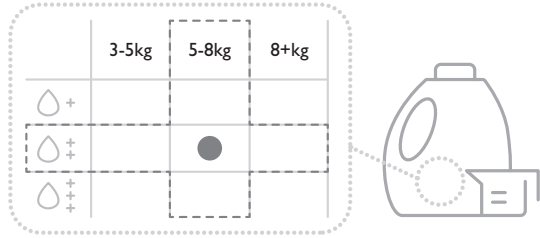

Water hardness levels

Levels	Water hardness range				
	°f ¹⁾	°d ²⁾	°e ³⁾	mmol/l	ppm
Soft	<15	<8	<10	<1.4	<140
Medium ⁴⁾	15 - 25	8 - 14	0 - 17	1.5 - 2.5	150 - 250
Hard	>25	>14	>17	>2.5	>250

- 1) French degrees
- 2) German degrees
- 3) English degrees
- 4) Factory setting, able to satisfy most of the use conditions.

10.4 How to set the water hardness level

Depending on the country, the water hardness is expressed in equivalent scales: e.g. French degrees (°f), German degrees (°d), English degrees (°e), mmol/l and ppm.

If necessary, please contact your local water authority to check the water hardness in your area.

Check in the "Water hardness levels" table which is the proper level.

To set the water hardness level:

1. Press the On/Off button for a few seconds to activate the appliance.
2. Wait about 10 seconds for appliance internal check.
3. Touch the Temperature and the Spin buttons simultaneously for some seconds until the display shows the default level **C02**.



4. Touch repeatedly the Temperature or Spin button until the desired level appears (from **C01** to **C03**).
5. Touch the Start/Pause button to confirm your choice and exit the menu.

10.5 AutoDose configuration mode



Enter the AutoDose configuration mode before proceeding with any program setting. The configuration mode may cancel temporary settings .

1. Press the On/Off¹⁾ button for a few seconds to activate the appliance.
2. Wait about 10 seconds for appliance internal check.
3. To enter in configuration mode, hold pressed the Temperature and the Spin buttons simultaneously for a few seconds

until **SEE** and the blinking detergent tank  and softener tank  indicators appear in the display. After 10 seconds without interacting with control panel the appliance exits the configuration mode.

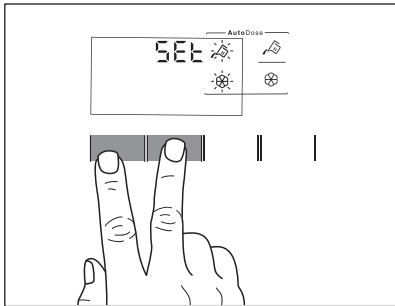

4. Touch related tank buttons to toggle function off and on. The display shows OFF when a tank is disabled or shows tank indicator when it is enabled.

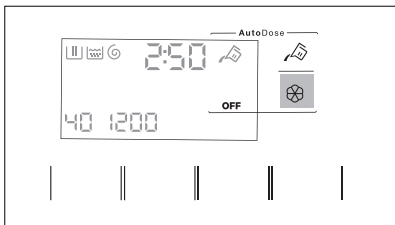

5. To set basic dosage touch related tank buttons until default dosage laundry product and two arrows on bottom of display appear. Touch the Temperature button repeatedly to decrease the dosage and the Spin button to increase it: minimum step is 1 ml (each single step) or 10 ml (when button is hold pressed).

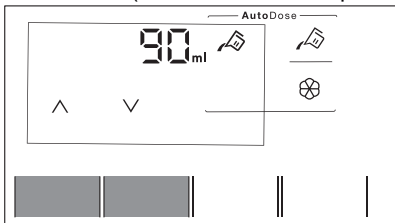

6. After about 10 seconds the display returns to the program information screen or hold pressed the Temperature and the Spin buttons again to exit immediately.

10.6 Filling the detergent and additives on AutoDose system



Please read "Detergents and other treatments" in "Hints and tips" chapter.



We recommend that you do not exceed the maximum indicated level (**MAX**).



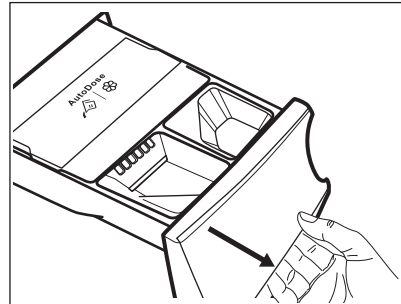

Please read "Detergents type and quantity of detergent" in "Hints and tips" chapter.

1. Open the detergent dispenser.

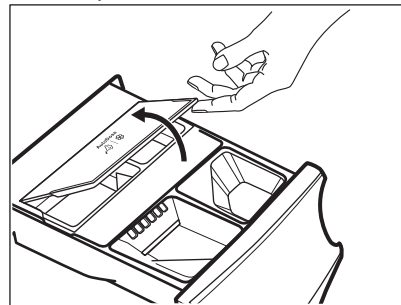

2. Lift up the AutoDose cover lid.



3. Gently pour only liquid detergent in the AutoDose detergent tank . Fill up to the maximum indicated level **MAX**.

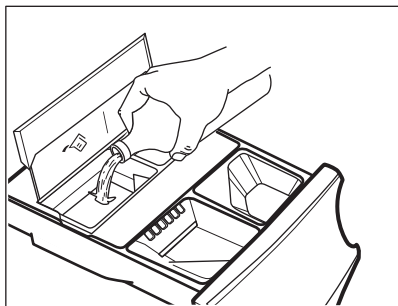

4. Gently pour only liquid softener in the AutoDose fabric softener tank . Fill up to the maximum indicated level **MAX**.

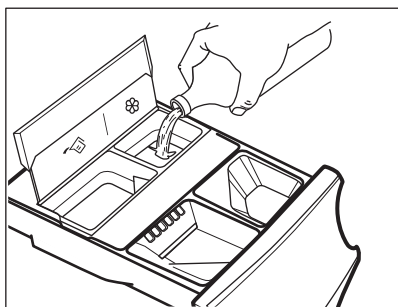

5. Lower down the AutoDose cover lid.

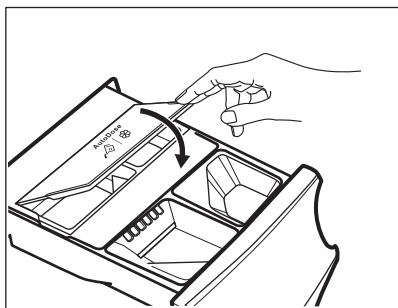

6. Gently close the detergent dispenser, till click engagement.

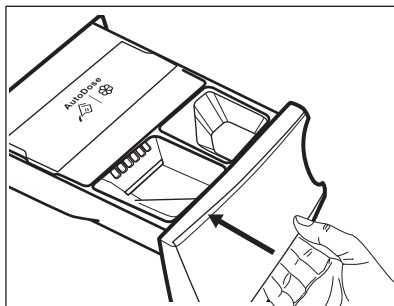

10.7 AutoDose low level indication



Do not refill the AutoDose tanks unless appliances indicates that one or both tanks are empty.

When the activated tank reaches a low level of detergent, related indicator blinks slowly and continuously on the display.

It will stop blinking when the compartment is refilled.

If tank is not refilled, once a program has started, the indicator will stop blinking and stay steadily lit. Once the programme is finished, it will start blinking again.

Unless AutoDose is turned OFF, if a compartment has reached low level, the set dosage for that compartment will be shown by the display for a few seconds each time the drawer is opened, to remind refill is needed.

If in both tanks detergent level is low, both indicators blink, but only the set dosage for detergent will be displayed.



If the tanks are filled before the appliance is powered on for the first time, the AutoDose indicator will not blink.

CAUTION!

The tanks refill must be carried out with the same brand and type of detergent/fabric softener/additive used before, otherwise clean the tanks before refilling.

10.8 Switching from AutoDose to manual dosing

It is possible to disable AutoDose function for one or both tanks by pressing related button symbol.

Example:

- To switch Fabric Softener tank off, press the softener  button until the display shows **OFF**.

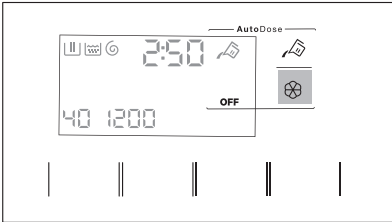

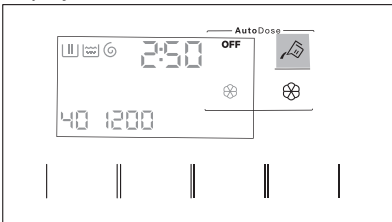

- If you need to use different detergent than ones present in AutoDose tanks, you could switch Detergent tank off by pressing the detergent  button until the display shows **OFF**.



10.9 Deactivating the AutoDose

If you want to use the machine ONLY manually, you can deactivate the Autodose functionality. Once you have entered the AutoDose configuration mode by a long press of Temperature and the Spin buttons:

1. Tap on the detergent  button or the softener  button until display shows **OFF**: the AutoDose is excluded completely for related tank or both.

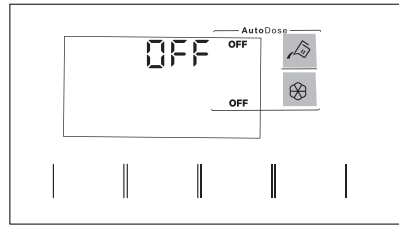

2. After about 10 seconds the display returns to the program information screen.

10.10 Manual filling the detergent and additives

You may need to use a different detergent or fabric softener than the ones used in the AutoDose tanks. First, make sure that the AutoDose tanks are disabled and then pour the detergent and/or other treatments in the manual compartments.





Do not exceed the maximum indicated level (**MAX**).

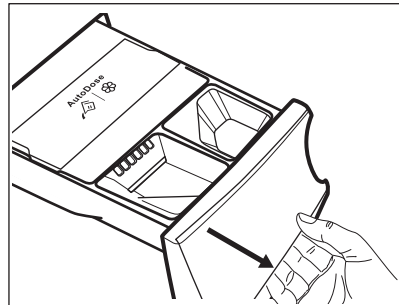

Please read "Detergents type and quantity of detergent" in "Hints and tips" chapter.

1. Open the detergent dispenser.



2. Put the powder detergent in the compartment . When using liquid detergent, refer to "Manual filling the liquid detergent".

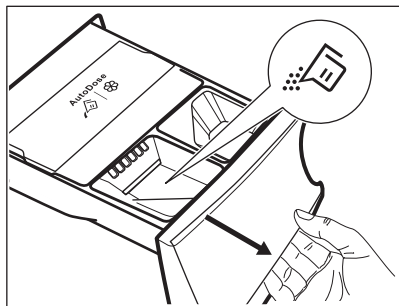

3. If desired, pour the fabric softener in the compartment  Manual .

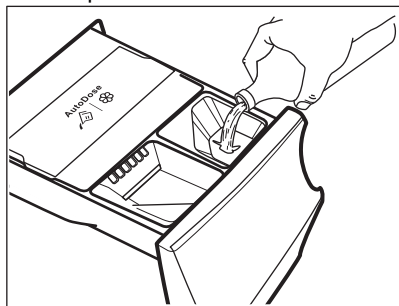

4. Gently close the detergent dispenser, till click engagement.

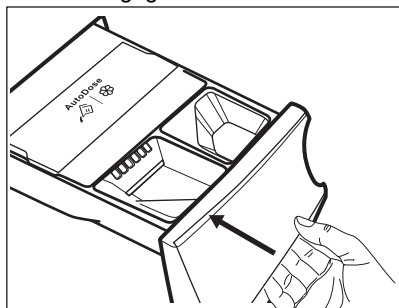

Manual filling the liquid detergent
1. Insert the container for liquid detergent.

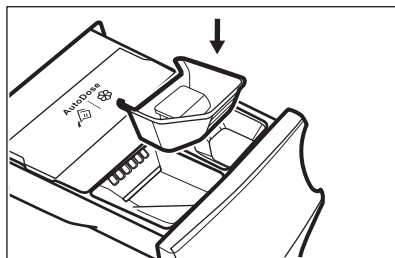

2. Pour the liquid detergent in the compartment .

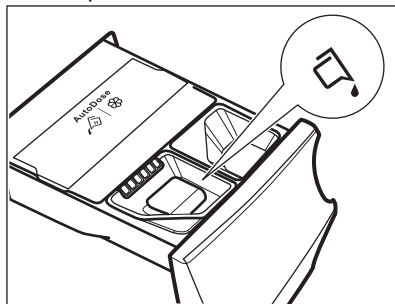

3. Gently close the detergent dispenser, till click engagement.

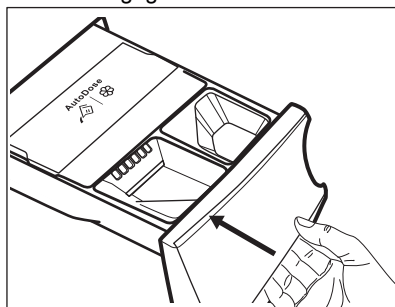

If the machine has not been used for more than 4 weeks with filled tanks, detergent/softener can become viscous or dry out. It is needed to clean the drawer as indicated in 'Care and Cleaning' chapter.

10.11 Drawer open indication

When a program is running, the detergent drawer must always be closed.

A sensor in the drawer detects if the drawer is open (or not properly closed) while the program is running. In such case, the appliance will immediately be paused.

If you press the Start/Pause  button, an error sound is generated and everything in

the display will turn off except the AutoDose indicators remain lit for a few seconds. Then the display returns to the previous paused state.

This will happen even if the user turned AutoDose off.

To restart the program, ensure the drawer is properly closed and press Start/Pause  button.

11. PROGRAMS

11.1 AEG App app and additional hidden programs

AEG App app provides you with a **wide choice of additional hidden programs**. Connect the appliance to AEG App and you will be able to choose the program that suits your needs most.

You can also memorize any of the hidden cycles in the favourite program  positions. To select the program from the appliance directly refer to the "Favourite programs" paragraph in "Dial and buttons" chapter.



Program names are subject to change depending on market requirements without notice. In the App you can find a complete description of each program.

Sportswear	Bed Linen	Denim	Machine Clean
Daily Training	Curtains	Silk	1 Item Fast
Down Jackets	Pillow	Baby	Anti-Allergy Vapour
Soccer/Rugby	Towels	Linen	Easy Iron
Skiing Gear	Duvet	Business Shirts	
Running Shoes	Pet Hair	Steam Cashmere	
Outdoor			



11.2 Program Chart



The programmes are described in this chart following the order of the selector dial from the top to the bottom.

Washing programs

Programme	Programme description
PowerClean 59min	Cotton and mixed synthetic fabrics. Ideal to wash your daily load in a short time, for a better clothes care and good cleaning already at 30°C.
Cottons Eco	White cotton and coloured cotton. Normally, heavily and lightly soiled items. The Cottons Eco program at 40 °C is recommended for a normally soiled full load of cotton and is the water and energy rating label program in accordance with AS/NZS2040 and AS/NZS6400.



Programme	Programme description
Cottons	White and coloured cotton fabrics. Ideal for normal and heavy soil.
Synthetics	Synthetic items or mixed fabric items. Normal soil.
Delicates	Delicate fabrics such as acrylics, viscose and mixed fabrics requiring gentler washing. Normal soil.
 Wool	Machine washable wool, hand washable wool and other fabrics with «hand washing» care symbol ¹⁾ .
20min 3kg	Cotton and synthetic items lightly soiled or worn only once.
 Steam	Cotton, synthetic and mixed items. Special steam cycle without washing that can be used to prepare your dried laundry for ironing or refreshing garments worn once. This programme reduces creases, odours and relaxes the fibres. Do not use any detergent. When the programme is completed, quickly remove the laundry from the drum ²⁾ . If necessary, remove stains by washing or using localized stain removal. Steam programmes do not perform any hygienic cycle. Do not set a Steam programme with these types of items: <ul style="list-style-type: none"> • Items that are not suitable for tumble drying. • Items with label "Dry clean only".
Bedlinen XL	Specific cycle developed for bed linen items (up to three bedlinen sets, one of which can be double size). Temperature settings and washing cycle duration are selected to obtain good washing performance in your daily cycles.
 Hygiene	White cotton items. This high-performance wash programme combined with steam vapour, removes more than 99,99% of bacteria and viruses ³⁾ keeping the temperature above 60°C throughout the washing phase; with an additional action on the fibers thanks to a vapour phase, an enhanced rinsing phase ensures a proper removal of detergent and micro-organism residues. This programme ensures also a proper reduction of pollens/allergenic items.
Rinse	All fabrics, except woollens and very delicate fabrics. Programme for rinsing and spinning the laundry. The default spin speed is the one used for cotton programmes. Reduce the spin speed accordingly to the type of laundry. If necessary, set the Extra Rinse option to add rinses. With a low spin speed the appliance performs delicate rinses and a short spin.
Spin/Drain	To spin the laundry and to drain the water in the drum. All fabrics, except woollens and delicate fabrics.

1) During this cycle the drum rotates slowly to ensure a gentle wash. It can seem that the drum doesn't rotate or doesn't rotate properly, but this is normal for this programme.

2) If you set a Steam programme with dried laundry, at the end of the cycle the laundry can be humid. Line dry the items for about 10 minutes. This programme does not remove particularly intense odour.

3) Tested for Staphylococcus aureus, Enterococcus faecium, Candida albicans, Pseudomonas aeruginosa and MS2 Bacteriophage in external test performed by Swisstat Testmaterialien AG in 2021 (Test Report No. 202120117).

Program temperature, maximum spin speed and maximum load

Programme	Default temperature Temperature range	Reference spin speed Spin speed range	Maximum load
PowerClean 59min	30 °C 60 °C - 30 °C	1600 rpm 1600 rpm - 400 rpm	5.0 kg
Cotton Eco 1)	40 °C 60 °C - 40 °C	1600 rpm 1600 rpm - 400 rpm	10.0 kg
Cottons	40 °C 95 °C - Cold	1600 rpm 1600 rpm - 400 rpm	10.0 kg
Synthetics	40 °C 60 °C - Cold	1200 rpm 1200 rpm - 400 rpm	4.0 kg
Delicates	30 °C 40 °C - Cold	800 rpm 1200 rpm - 400 rpm	2.0 kg
 Wool	40 °C 40 °C - Cold	1200 rpm 1200 rpm - 400 rpm	2.0 kg
20min 3kg	30 °C 40 °C - 30 °C	1200 rpm 1600 rpm - 400 rpm	3.0 kg
 Steam	-	-	1.0 kg
Bedlinin XL	30 °C 60 °C - Cold	1200 rpm 1200 rpm - 400 rpm	4.5 kg
 Hygiene	60 °C	1600 rpm 1600 rpm - 400 rpm	10.0 kg
Rinse	-	1600 rpm 1600 rpm - 400 rpm	10.0 kg
Spin/Drain	-	1600 rpm 1600 rpm - 400 rpm	10.0 kg

1) The cotton programme at 40 °C with the **ECO** option is recommended for a full load of normally soiled cotton and is the water and energy rating label programme in accordance with AS/NZS2040.2 and AS/NZS6400.

11.3 Steam programs

The Steam programs can be used for reducing wrinkles and odours on garments (such as cottons, synthetics, mixed fabrics, including delicates) that just need to be refreshed, in a short time, avoiding washing.

The fabric fibres are relaxed and afterwards ironing becomes effortless. When the cycle is completed, quickly remove the laundry from the drum.

The cycle duration can be reduced till 15 minutes by means of the Time Save option.

DO NOT set this mode with the following type of items:

- Items that are not suitable for tumble drying.
- Items with label "Dry clean only".



Do not use any detergent!
 The Steam programs do not remove particularly intense odour and do not perform any hygienic cycle.
 After the steam treatment the laundry can be humid. Hang items out for a few minutes.

11.4 Woolmark Wool Care - Green







The wool wash cycle of this machine has been approved by The Woolmark Company for the washing of wool garments labelled as «hand wash» provided that the products are washed according to the instructions on the garment label and those issued by the manufacturer of this washing machine. M1361
 The Woolmark symbol is a Certification mark in many countries.

11.5 Options compatibility with programs



Additional programs and settings are available downloading the APP.

	PowerClean 59min	Cotton Eco	Cottons	Synthetics	Delicates	Wool	20min 3kg	Steam	Bedlinen XL	Hygiene	Rinse	Spin/Drain
AutoDose												
AutoDose Detergent	■	■	■	■	■		■		■	■		
AutoDose Fabric Softener	■	■	■	■	■	■	■		■	■		■
Others												

	PowerClean 59min	Cotton Eco	Cottons	Synthetics	Delicates	Wool	20min 3kg	Steam	Bedlinen XL	Hygiene	Rinse	Spin/Drain
Spin	■	■	■	■	■	■	■		■	■	■	
 Rinse Hold	■	■	■	■	■	■				■	■	
 Extra Silent		■	■	■	■							
--- No Spin												■ ¹⁾
 Stains ²⁾		■	■	■						■		
 Prewash		■	■	■								
Time Save ³⁾		■	■	■				■	■			
Extra Rinse	■	■	■	■	■				■	■	■	
Plus Steam ²⁾	■	■	■	■					■	■		
Finish In	■	■	■	■	■	■	■	■	■	■	■	■

¹⁾ If you set the No Spin option, the appliance performs draining only.

²⁾ This option is not available with temperature lower than 40 °C.

³⁾ If you set the shortest duration, we recommend that you decrease the load size. It is possible to fully load the appliance, however the washing results can be less satisfactory.

Suitable detergents for washing programs

Programme	Universal powder ¹⁾	Liquid Universal	Liquid for coloureds	Delicates woollens	Special
PowerClean 59min	--	▲	▲	--	--
Cottons Eco	▲	▲	▲	--	--
Cottons	▲	▲	▲	--	--
Synthetics	▲	▲	▲	--	--
Delicates	--	--	--	▲	▲

Programme	Universal powder ¹⁾	Liquid Universal	Liquid for coloureds	Delicates woollens	Special
Wool	--	--	--	▲	▲
20min 3kg	--	▲	▲	--	--
Bedlinen XL	--	--	--	▲	▲
Hygiene	▲	▲	--	--	▲

1) At temperature higher than 60 °C the use of powder detergent is recommended.

▲ = Recommended

-- = Not recommended

12. 📶 WI-FI - CONNECTIVITY SETUP

This chapter describes how to connect the smart appliance to the Wi-Fi network and to link it to mobile devices.

By this functionality you can receive notifications, control and monitor your appliance from your mobile devices.

The Wi-Fi functionality is off as factory default setting.

To connect the appliance to enjoy the full range of features and services you need:

- Wireless network at home with internet connection enabled.
- Mobile device connected to wireless network.

Frequency	2.4 GHz according to local country regulation
Protocol	IEEE 802.11b/g/n
Max power	According to local country regulation
Encryption	WPA, WPA2, WPA3



Minimum requirements: Operating system compatibility iOS 15/Android 7.1 and above. Install the AEG App, create an account and accept the Terms and Conditions and AEG Privacy Policy to use the connected features. Stable Internet and good Wi-Fi connection with 2.4GHz wireless frequency is required. Minimum requirements, apps and services are subject to change without notice.

12.1 QR code on rating plate

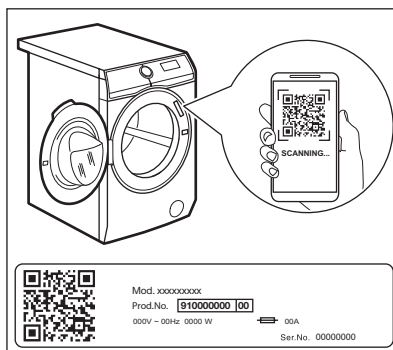

QR code can be used in two ways:

- Scan the QR code with the built-in camera app to register your product.
- Pairing your smart device with appliance to simplify the process. Scan the QR code

with QR code scanner built-in AEG App application.

12.2 Installing and configuring AEG App



AEG App allows you to control your laundry through a mobile device. It contains a large number of programs, useful features and product information tailored perfectly to the appliance. Through the app you can select the programs already available from the appliance control panel, plus unlock additional programs available only from a mobile device. Additional programs can change over the time along with new versions of the app. It's personalized laundry care - all from your mobile device.



When connecting the appliance to the application, stand near it with your mobile device.

Make sure that your mobile device is connected to the wireless network.

1. Go to the App Store on your smart device or scan QR code (see 'QR code on rating plate' paragraph).
2. Download and install the AEG App App.
3. Make sure you started a Wi-Fi connection in the appliance. If not, read the next paragraph 'Configuring the appliance wireless connection'.
4. Start the application. Select the country and language and login with Your email and password. If you do not have an account, create a new one following the instructions in AEG App.
5. Follow the instructions on the App for the appliance registration and configuration.

12.3 Configuring the appliance wireless connection

1. Press the On/Off  button for a few seconds to activate the appliance. Wait about 10 seconds before proceeding with wireless configuration.
2. Select a program by turning the program dial.

3. Press and hold the Remote Start  button for a few seconds until a 'click' sounds. Release the button. **On** appears on the display for 5 seconds and the indicator  starts blinking.

The wireless module begins starting up.



Make sure that you APP is ready for connection.

4. After about 10 seconds, **AP** (**Access Point**) appears on the display.



The access point will be open for about 3 minutes.

5. Configure the AEG App app on your smart device and follow the instructions to connect the appliance to your Wi-Fi network.
6. If the connectivity is configured, when the program information screen returns, the indicator  is on the display.





Every time you switch the appliance on, the appliance takes about 10 seconds to connect to the network automatically. When the indicator  stops blinking the connection is ready.

To switch the wireless connection off,

press and hold the Remote Start  button for a few seconds until the first acoustic signal.

Release the button. *OFF* appears on the display for 5 seconds.



If you switch the appliance off and on again, the wireless connection is automatically off.

To remove the wireless credentials, press and hold the Remote Start  button for a few seconds until the second acoustic signal:

--- appears on the display for a few seconds.



12.4 Remote Start

The Remote Start enables you to start a cycle in remote control.





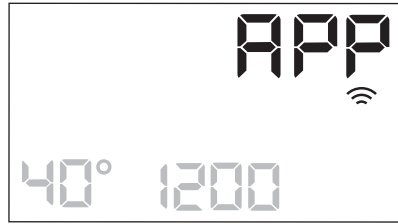

The Remote Control activates automatically when you press the Start/Pause  button to start the program, but it is also possible to start a washing program remotely. This function is deactivated when door is open.

When the App is installed and the wireless connection is complete, you can activate the Remote Start:



1. Touch the Remote Start  button and the indicator  blinks on the display for a few seconds.





2. Touch the Start/Pause  button to activate the Remote Start before the indicator  stops blinking.

The indicators  and  appear on the program summary screen and the door is locked. Now it is possible to start the program remotely.



When touching the Start/Pause  button after the indicator  stops blinking, the Remote Start is not activated, but the set program starts.

To remove the Remote Start, tap on the Remote Start  button and confirm by pressing the Start/Pause  button.

12.5 Over-the-air update

The App may propose an update for your appliance.

The update is accepted via App only.

If a program is running, the App notifies that the update will start at the end of the program.

During the update, the appliance shows  in the display.

Do not switch off or unplug the appliance during update.

The appliance will be usable again at the end of the update, without any notification about successful update.

If an error occurs, the appliance shows  in the display: just press any buttons or turn the knob to return to normal use.

12.6 Wi-Fi Always On

The Wi-Fi Always On function is available in the App.

This function keeps the appliance connected to the network even when the appliance is turned off.

The indicator  goes on and off intermittently (1 second on , 5 seconds off).

It is possible to turn the appliance on by pressing the On/Off  button or through the App.



The Wi-Fi Always On function may affect your energy consumption.

13. DAILY USE

WARNING!

Refer to Safety chapters.

13.1 Activating the appliance

1. Connect the mains plug to the mains socket.
2. Open the water tap.
3. Press the On/Off  button for a few seconds to activate the appliance.

A short tune sounds. The appliance automatically proposes a default program. The relevant indicator illuminates.

The display shows the cycle duration, the maximum load (for a few seconds), the default temperature, the default spin speed and the indicators of the phases making up the program.

13.2 Loading the laundry

1. Open the appliance door.
2. Shake the items before you put them in the appliance.
3. Put the laundry in the drum, one item at a time.

Make sure not to put too much laundry in the drum.

4. Close the door firmly.

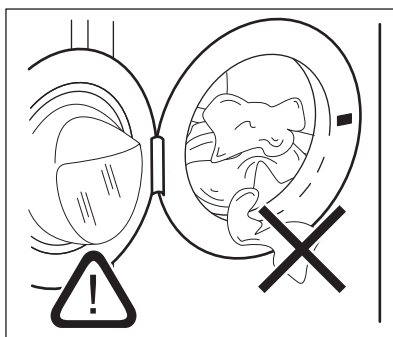

CAUTION!

Make sure that no laundry stays between the seal and the door. There is a risk of water leakage or damage to the laundry.

CAUTION!

Washing heavily oiled, greasy stains could cause damage rubber parts of the washing machine.

13.3 Using detergent and other treatments

If both AutoDose tanks are enabled in the set programme, detergent and fabric softener are automatically loaded.

If one of the AutoDose tank or both are disabled (OFF) in the set programme, proceed by manually filling the product in the proper compartment.

13.4 Setting a program



If you wish to change the automatic detergent or fabric softener dosage, enter the AutoDose configuration mode before proceeding with any program setting. The configuration mode may cancel temporary settings. Please refer to "AutoDose configuration mode" paragraph in "The AutoDose Technology (Autodosing)" chapter.

1. Turn the program dial to select the desired washing program. The related program indicator comes on.

The indicator of the Start/Pause  button flashes.

The display shows an indicative program duration, the maximum declared load for the set program (only for a few seconds), the default temperature, the default spin speed and the washing phase indicators (when available).

2. To change the temperature and/or the spin speed, touch the related buttons.
3. If desired, set one or more options by touching the related buttons. The related indicators come on in the display and the given information changes accordingly.



In case a selection is **not possible**, no indicator comes on and an acoustic signal sounds.

13.5 Starting a program



Make sure that the detergent dispenser is firmly closed, otherwise program won't start.

1. Touch the Start/Pause  button. This triggers the **Confirm LED** indicator to begin flashing, signifying that the appliance is in standby confirmation state.
2. Touch the **Confirm Start** button within 10 seconds to complete the activation sequence.

The programme starts, the door is locked.

The display shows the indicator .





The drain pump can operate shortly before the appliance fills water.



WARNING!
If the Confirm Start touch button is not pressed within 10 seconds time period, the appliance will automatically exit the activation state.

13.6 Starting a program with the Finish In option

1. Touch Finish In button repeatedly until the display shows the desired time within the program should end. The indicator  comes on.

2. Touch the Start/Pause  button. This triggers the **Confirm LED** indicator to begin flashing, signifying that the appliance is in standby confirmation state.

3. Touch the **Confirm Start** button within 10 seconds to complete the activation sequence. If the Confirm Start touch button is not pressed within 10 seconds time period, the appliance will automatically exit the activation state.

The drum starts rotating to perform the ProSense estimation, if foreseen in the selected program.

4. The appliance starts the countdown to the end of the program and the program will start at the right moment for ending at the time set through this option.

To change or cancel this option:

1. Switch the appliance off by means of the On/Off  button.
2. Switch the appliance on again.
3. Set the program again.

13.7 The ProSense load detection

ProSense





The program duration in the display is referred to a **medium/high load**.

After setting a washing program, the **ProSense** icon lights up on the display if the program supports it.

After touching the Start/Pause button, the ProSense starts the laundry load detection:

i
When the Start/Pause button is pressed, Confirm LED starts blinking until **Confirm Start** button is pressed.

1. The appliance detects the load in the first 30 seconds: the indicator  flashes, the bars under the **ProSense** icon move back and forth and the drum rotates shortly.
2. When the drum stops rotating, the display shows the new program duration, that could increase or decrease, adjusted accordingly the load detected, the number of bars indicates the load in quarter (from 1 to 4, 4 bars in case of overload), the maximum declared load indicator comes on again. After further 30 seconds, the water filling starts.

i
In case of **drum overload**, the maximum declared load indicator comes on again with the **MAX** indicator blinking. In this case, during these 30 seconds, it is possible to pause the appliance and remove the exceeding garments. Once removed the exceeding garments, touch the Start/Pause button and **Confirm Start** button to start the program again. The ProSense phase can be repeated up to three times (see point 1).

⚠ WARNING!
If the Confirm Start touch button is not pressed within 10 seconds time period, the appliance will automatically exit the activation state.

Important! If the laundry amount will not be reduced, the washing programme starts anyway, despite the overload. In this case, it

will be not possible to guarantee the best washing results.

i
About 20 minutes after the program start, the programme duration could be adjusted again depending on the capacity of water absorption of the fabrics.

i
The ProSense detection is carried out with complete washing programs only (no skipping phase selected).

i
The ProSense is not available with some programs, such as Wool, programmes with short cycles and without washing phase.

i
In certain programs the duration of cycle could be the same for different load size, but water and energy consumption are anyway tailored made to achieve best results.

13.8 Programme phase indicators

When the programme starts the indicator of the running phase flashes and the other phase indicators are steady on.

E.g. the washing or pre wash phase is

running: 

When the phase ends the relevant indicator stops flashing and is steady on. The next phase indicator starts flashing.

E.g. the rinse phase is running: 

If you select the Plus Steam the steam phase indicators come on.

The steam phase is running: 

The anti-crease phase is running: 

13.9 Interrupting a program and changing the options

When the program is running, you can change **only some** options:

1. Touch the Start/Pause▶|| button. The related indicator flashes.
2. Change the options. The given information in the display changes accordingly.
3. Touch the Start/Pause▶|| button again. This triggers the **Confirm LED** indicator to begin flashing, signifying that the appliance is in standby confirmation state.
4. Touch the **Confirm Start** button within 10 seconds to complete the activation sequence.

The washing program continues.

WARNING!

If the Confirm Start touch button is not pressed within 10 seconds time period, the appliance will automatically exit the activation state.

13.10 Cancelling a running program

1. Press the On/Off⓪ button to cancel the program and to deactivate the appliance.
2. Press the On/Off⓪ button again to activate the appliance.

Now, you can set a new washing program.



If the ProSense phase is already carried out and the water filling is already started, the new program starts **without repeating the ProSense phase**. The water and the detergent are not drained out in order to avoid waste. The display shows the maximum duration of the program, updating it about 20 minutes after the starting of the new program.

13.11 Opening the door - Adding garments

While a programme or the delay start operates, the appliance door is locked.



If the temperature and level of the water in the drum are too high and/or the drum still rotates you cannot open the door.

You can easily open the door for adding or removing some items when the icon  is lighted on.

1. Touch the Start/Pause▶|| button. In the display the related door lock indicator goes off.
2. Open the appliance door. If necessary, add or remove the items.
3. Close the door and touch the Start/Pause▶|| button.

The program or the delay start continues.

When the icon  goes off, the door can be opened when the program is complete. You may also set a spinning or draining program/option and then press Start/Pause▶|| button. If the spin and drain programs are not available in the program dial, they can be set via App.

13.12 End of the program

When the program has finished, the appliance stops automatically. The acoustic signals operate (if they are active).

In the display all washing phase indicators become steady and the time area shows .

The indicator of the Start/Pause▶|| button goes off.

The door unlocks and the indicator  goes off.

1. Press the On/Off⓪ button to deactivate the appliance.

After five minutes from the end of the program, the energy saving function automatically deactivates the appliance.







When you activate the appliance again, the display show the end of the last selected program. Turn the program dial to set a new cycle.



2. Remove the laundry from the appliance.



3. Make sure that the drum is empty.
4. Keep the door and the detergent dispenser slightly ajar to prevent mildew and odours.
5. Close the water tap.



13.13 Draining water out after end of cycle

If you have chosen a program or an option that does not empty out the water of the last rinse, the program is completed, but:

- The display shows the indicator , the option indicator  or **dB** and the door locked indicator . The indicator of the running phase  flashes.
- The drum still turns at regular intervals to prevent the creases in the laundry.
- The door stays locked.
- You must drain the water to open the door:

1. If necessary, touch the Spin button to decrease the spin speed proposed by the appliance.
2. Touch the Start/Pause  button:
 - If you have set , the appliance drains the water and spins.
 - If you have set **dB**, the appliance only drains the water.

The option indicator  or **dB** goes off, while the indicator  flashes and then goes off.

3. When the program is completed and the door locked indicator  goes off, you can open the door.
4. Press the On/Off  button a few seconds to deactivate the appliance.



In any case, the appliance empties the water out automatically after approximately 18 hours.

13.14 Stand-by option

The Stand-by function automatically deactivates the appliance to decrease the energy consumption when:

- You do not use the appliance for 5 minutes before you touch the Start/Pause  button.

Press the On/Off  button to activate the appliance again.

- After 5 minutes from the end of the washing program

Press the On/Off  button to activate the appliance again.

The display shows the end of the last set program.

Turn the program dial to set a new cycle.



If you set a program or an option that ends with water in the drum, the Stand-by function **doesn't deactivate** the appliance to remind you to drain the water.



If the Wi-Fi Always On function is active, only the indicator  goes on and off intermittently.

14. CARE AND CLEANING

WARNING!

Refer to Safety chapters.

14.1 Periodic cleaning schedule

Periodic cleaning helps to extend the life of your appliance.

After each cycle, keep the door and the detergent dispenser slightly ajar to get air circulation and dry the humidity inside the appliance: this will prevent mildew and odours.

If the appliance is not used for a long time: close the water tap and unplug the appliance.

Indicative periodic cleaning schedule:

Descaling	Twice a year
Maintenance wash	Once a month
Clean door seal	Every two months
Clean drum	Every two months
Clean detergent dispenser and AutoDose tanks	Twice a year
Clean drain pump filter	Twice a year
Clean the inlet hose and the valve filter	Twice a year

The following paragraphs explain how you should clean each part.

14.2 Removing foreign objects



Make sure that pockets are empty and all loose elements are tied up before running your cycle. Refer to "The laundry load" in "Hints and tips".

Remove any foreign objects (such as metal clip, buttons, coins, etc) that you may find in the door seal, the filters and the drum. Refer to "Door seal with double lip trap", "Cleaning the drum", "Cleaning the drain pump" and "Cleaning the inlet hose and the valve filter" paragraphs. If necessary, please contact the Authorised Service Centre.

14.3 External cleaning

Clean the appliance with mild soap and warm water only. Fully dry all the surfaces.

Do not use a scouring pads or any scratching material.

CAUTION!

Do not use alcohol, solvents or chemical products.

CAUTION!

Do not clean the metal surfaces with chlorine-based detergent.

14.4 Descaling



If the water hardness in your area is high or moderate, we recommend that you use a water descaling product for washing machines.

Regularly examine the drum to check for limescale.

The regular detergents already contain water softening agents, but we recommend to run a cycle with empty drum and a descaling product occasionally.



Always follow the instructions that you find on the packaging of the product.

14.5 Maintenance wash

The repeated and prolonged use of low temperature and short programs can cause detergent deposits, fluff residues, bacterial growth and biofilm formation inside the drum and the tub. This could generate bad odours and mildew.

To eliminate these deposits and hygienize the inner part of the appliance, run a maintenance wash at least once a month:

1. Remove all laundry from the drum.
2. Deactivate AutoDose function for detergent and softener.
3. Run a cotton program with the highest temperature without detergent.

14.6 Door seal

This appliance is designed with a **self cleaning draining system**, allowing light fluff fibers that fall off the clothes to be drained out with the water. Regularly examine the seal. Coins, buttons, other small items can be recovered at the end of the cycle.

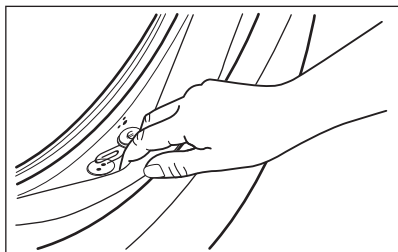

Clean it when needed, using ammonia cream cleanser agent without scratching the seal surface.



Always obey the instructions that you find on the packaging of the product.

14.7 Cleaning the drum

Regularly examine the drum to prevent unwanted deposits.

Rust deposits in the drum may occur due to rusting foreign body in the washing or tap water containing iron

Clean the drum with special products for stainless steel.



Always follow the instructions that you find on the packaging of the product. Do not clean the drum with acidic descaling products, scouring products containing chlorine or iron or steel wool.

For a thorough clean:

1. Clean the drum with special products for stainless steel.



Always follow the instructions that you find on the packaging of the product.

2. Remove all laundry from the drum.



Do not use any detergent.

3. Deactivate AutoDose function for detergent and softener.
4. Run a cotton program with the highest temperature without detergent. If your appliance can be connected to Wi-Fi, the

special program Machine Clean is also downloadable through the APP.

14.8 Cleaning the detergent dispenser and the AutoDose tanks

⚠ CAUTION!

Do not change brand or type of detergent, fabric softener or additives inside the tanks without cleaning both tanks before.



Before cleaning, make sure that the all compartments are empty.

To prevent possible deposits of dried detergent, clotted fabric softener, formation of mould in the detergent dispenser and/or clotted liquid additives in the AutoDose tanks, **once in a while carry out the following cleaning procedure:**

1. Open the detergent dispenser. Press the catch as indicated in the picture and pull the detergent dispenser out.

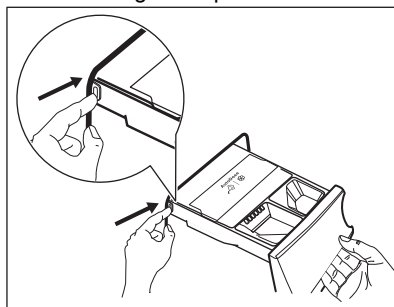

2. Remove the insert for the softener and, if inserted, the container for liquid detergent.

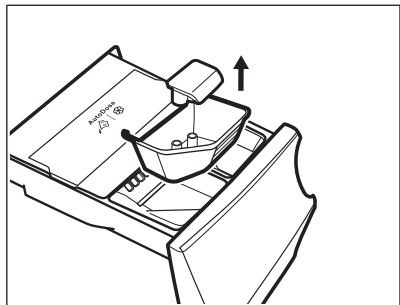
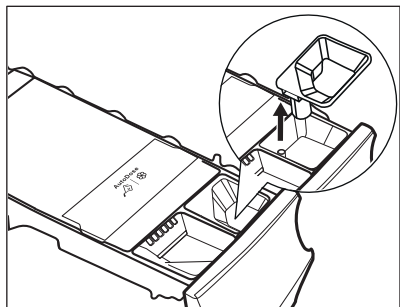

3. Press the catch on the back as indicated in the picture and lift up the top cover to remove it.

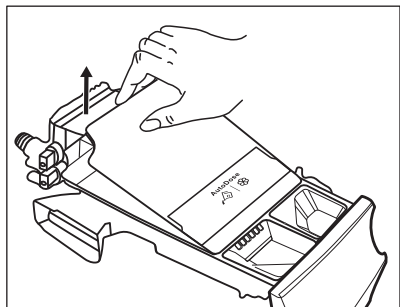
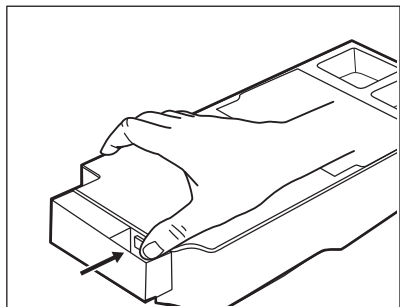

4. To remove any detergent residue or if you place a wrong additives in the tanks, empty the drawer in a basin or in suitable containers to collect the liquid.

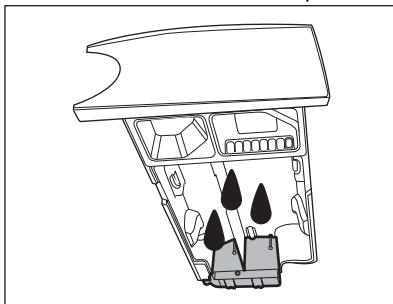

5. Wash the drawer and all inserts under running water or clean it with a damp cloth.

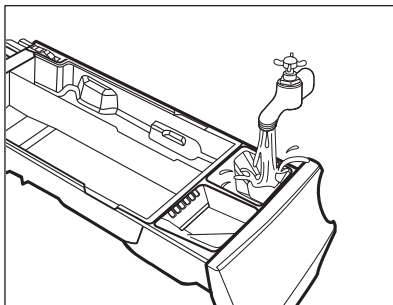

⚠ CAUTION!

Do not use sharp or metal brushes and sponges. Do not wash drawer in a dish washer.

6. Turn the dispenser up side down and open the bottom cover as indicated in the picture.

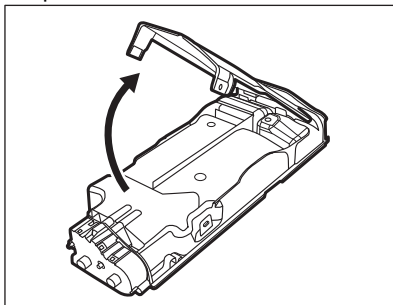

7. Make sure that all detergent residue is removed from the conveyor. Use only soft damp clothes.
8. Put bottom cover back to its position by aligning its holes on drawer hooks as indicated in the picture. Close it till "click" sound.

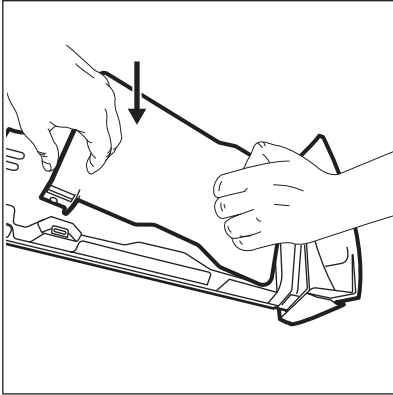

⚠ CAUTION!

Press the bottom cover as indicated in the picture. Make sure that it is closed properly.

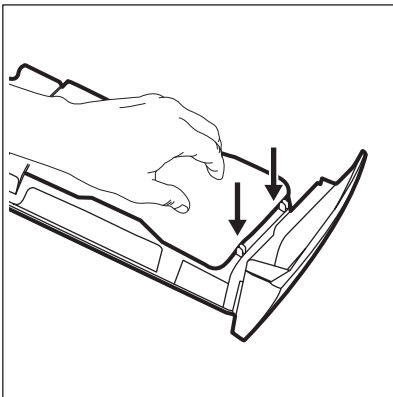

⚠ WARNING!

Do not clean with any sharp and metal brushes or any tools, pumps or sensors allocated on the back of the detergent drawer. If necessary, use only soft damp clothes.

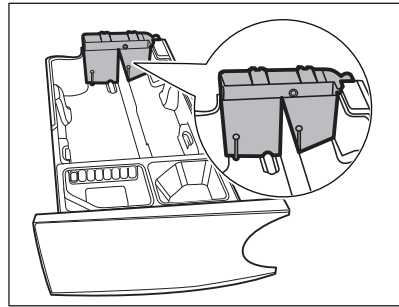

⚠ WARNING!

If some residues remain on the back area of tanks, soak detergent drawer in a warm water. Do not use tools to clean it. Before soaking, remove the handle by pressing red button and slide the handle as indicated in the picture.

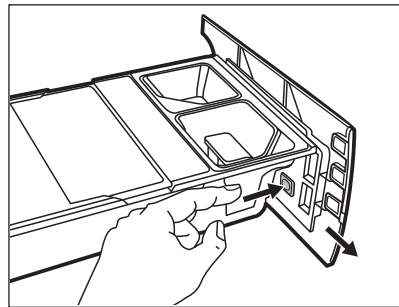

9. Make sure that all detergent residue is removed from the upper and lower part of the recess. Use a small brush to clean the recess.

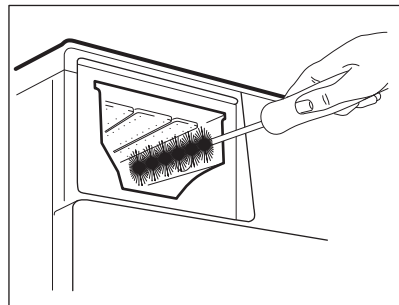

10. Reassembly the drawer as follows:
 - a. Place the handle if was disassembled.

- b. Place the bottom cover and press till "click" sound.
- c. Place the top cover on the tanks compartment and press till "click" sound.
- d. Replace components on manual compartment.

11. Insert the detergent dispenser into the guide rails and gently close it till "click" sound. Run the rinsing programme without any clothes in the drum.

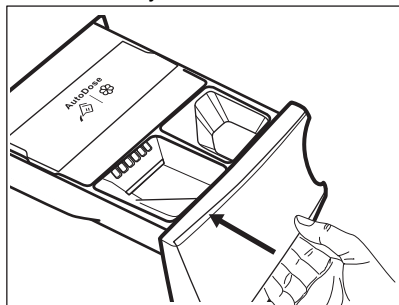

To restore the functionality, refill tanks with detergent and softener.

14.9 Cleaning the drain pump filter

WARNING!

Disconnect the mains plug from the mains socket.



Regularly check the drain pump filter and make sure that it is clean.

Clean the drain pump filter if:

- The appliance does not drain the water.
- The drum does not turn.
- The appliance makes an unusual noise because of the blockage of the drain pump.
- The display shows the alarm code **E2 1**.

WARNING!

- Do not remove the filter while the appliance operates.
- Do not clean the pump if the water in the appliance is hot. Wait until the water cools down

Proceed as described in following diagrams to clean the pump filter:

Always keep a rag nearby to dry up any water spillages when removing the filter.

1. Open the pump cover.

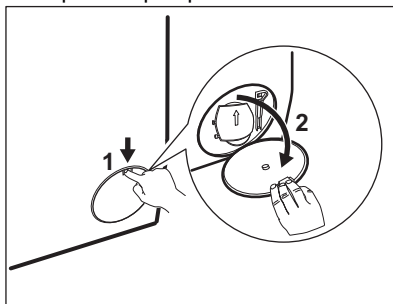

2. Place a suitable bowl below the drain pump access to collect the water that flows out.

3. Open the chute downwards. Always keep a rag nearby to dry up any water spillages when removing the filter.

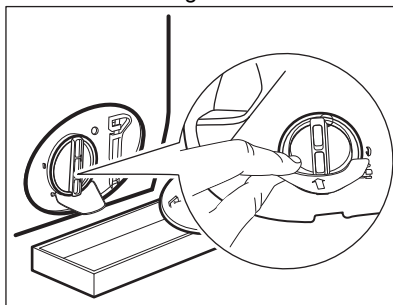

4. Turn the filter 180 degrees in anti-clockwise direction to open it, without removing. Let the water flow out.

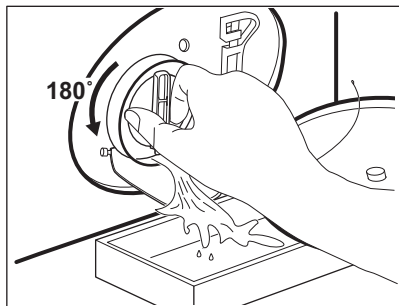

5. When the bowl is full of water, turn the filter back and empty the container.
6. Repeat the steps 4 and 5 until the water stops to flow out.
7. Turn the filter anti-clockwise to remove it.

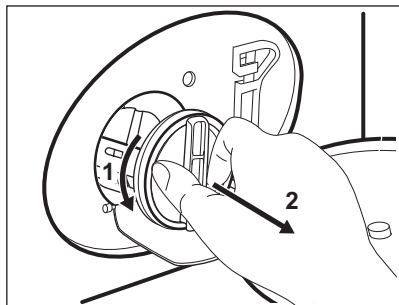

8. If it is necessary, remove fluff and objects from the filter recess.
9. Make sure that the impeller of the pump can rotate. If it does not rotate, contact the Authorised Service Centre.

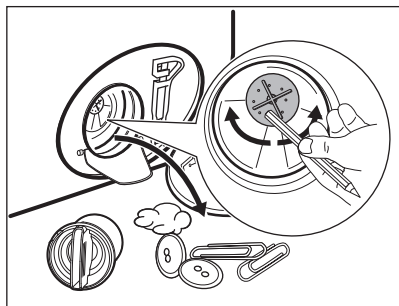

10. Clean the filter under the water tap.

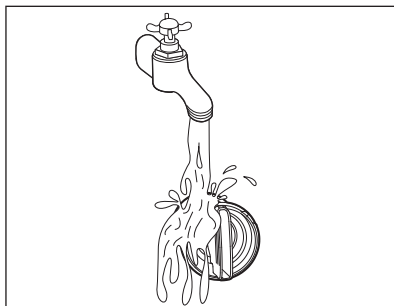

11. Put the filter back into the special guides by turning it clockwise. Make sure that you tighten the filter correctly to prevent leakages.

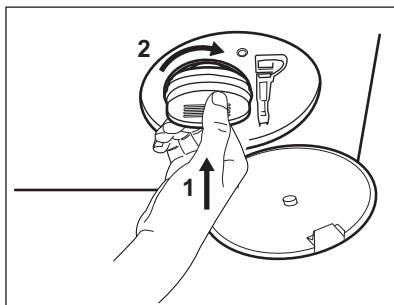

12. Close the pump cover.

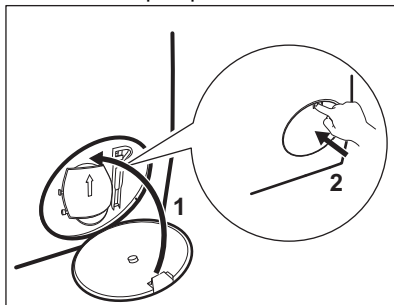

When you drain the water with the emergency drain procedure, you must activate the drain system again:

- a. Put 2 litres of water in the main wash compartment of the detergent dispenser.
- b. Start the program to drain the water.

14.10 Cleaning the inlet hose and the valve filter

It is recommended to clean both the filters of the inlet hose and valve occasionally to remove any deposit, collected over the time:

1. Remove the inlet hose from the tap and clean the filter.

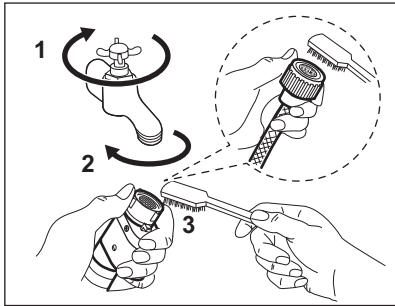

2. Remove the inlet hose from the appliance by loosening the ring nut.

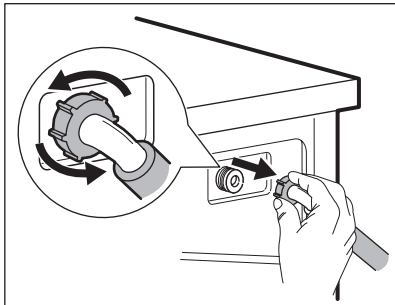

3. Clean the valve filter on the back of the appliance with a toothbrush.

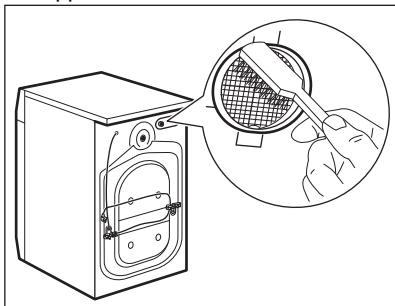

4. When you reconnect the hose to the back of the appliance, turn it left or right (not in vertical position) depending on the position of your water tap.

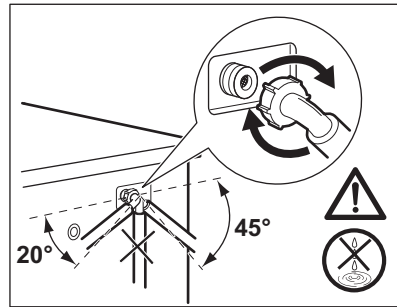

14.11 Emergency drain

If the appliance cannot drain the water, carry out the same procedure, described in 'Cleaning the drain pump' paragraph. If necessary, clean the pump.

When you drain the water with the emergency drain procedure, you must activate the drain system again:

1. Put 2 litres of water in the main wash compartment of the detergent dispenser.
2. Start the program to drain the water.

14.12 Frost precautions

If the appliance is installed in an area where the temperature can reach the values around 0° C or drop below, remove the remaining water from the inlet hose and the drain pump.

1. Disconnect the mains plug from the mains socket.
2. Close the water tap.
3. Put the two ends of the inlet hose in a container and let the water flow out of the hose.
4. Empty the drain pump. Refer to the emergency drain procedure.
5. When the drain pump is empty, install the inlet hose again.

! WARNING!

Make sure that the temperature is higher than 0 °C before you use the appliance again.

The manufacturer is not responsible for damages caused by low temperatures.

15. TROUBLESHOOTING

WARNING!

Refer to Safety chapters.

15.1 Alarm Codes and Possible failures

The appliance does not start or it stops during operation. First try to find a solution to the problem (refer to the tables).

WARNING!

Deactivate the appliance before carrying out any check.

With some problems, the display shows an alarm code and the Start/Pause  button may flash continuously:



If the appliance is overloaded, remove some items from the drum and/or keep pressed the door while touching the Start/Pause button until the indicator  stops flashing (see the picture below).

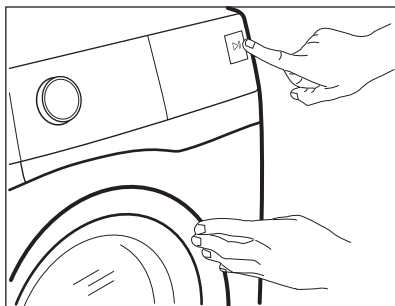

Problem	Possible solution
E11 The appliance does not fill with water properly.	<ul style="list-style-type: none">• Make sure that the water tap is open.• Make sure that the pressure of the water supply is not too low. For this information, contact your local water authority.• Make sure that the water tap is not clogged.• Make sure that the inlet hose has no kinks, damages or bends.• Make sure that the connection of the water inlet hose is correct.• Make sure that the filter of the inlet hose and the filter of the valve are not clogged. Refer to 'Care and cleaning'.

E21

The appliance does not drain the water.

- Make sure that the sink spigot is not clogged.
- Make sure that the drain hose has no kinks or bends.
- Make sure that the drain filter is not clogged. Clean the filter, if necessary. Refer to "Care and cleaning".
- Make sure that the connection of the drain hose is correct.
- Set the drain programme if you set a programme without drain phase. If the drain programme is not available in the programme dial, it can be set via App.
- Set the drain programme if you set an option which ends with water in the tub.

E41

The appliance door is open or not closed correctly.

- Make sure that the door is properly closed.

E91

Internal fail. No communication between electronic elements of the appliance.

- The programme was not finished properly or the appliance stopped too early. Switch the appliance off and on again.
- If the alarm code appears again, contact the Authorised Service Centre.

EH1

Frequency of power supply is out of range.

EH2

Supply voltage is too high.

EH3

Supply voltage is too low.

EF3



The anti-flood device is on.

- Disconnect the appliance and close the water tap. Contact the Authorised Service Centre.

If the display shows other alarm codes, deactivate and activate the appliance. If the problem continues, contact the Authorised Service Centre.

In case of different problem with the appliance check the table below for possible solutions.

Problem	Possible solution
The programme does not start.	<ul style="list-style-type: none">• Make sure that the mains plug is connected to the mains socket.• Make sure that the appliance door is closed.• Make sure that there is no damaged fuse in the fuse box.• Make sure that the Start/Pause  has been touched.• If the delay start is set, cancel the setting or wait for the end of countdown.• Make sure that the detergent dispenser is firmly closed.• Deactivate the Child Lock function if it is on.• Check the position of the knob on the selected programme.• Press the "Confirm Start" touch button within 10 seconds.
The appliance fills with water and drains immediately.	<ul style="list-style-type: none">• Make sure that the drain hose is in the correct position. The hose may be positioned too low. Refer to "Installation instruction".
The spin phase does not operate or the washing cycle lasts longer than usual.	<ul style="list-style-type: none">• Set the spin programme. If the drain programme is not available in the programme dial, it can be set via App'.• Make sure that the drain filter is not clogged. Clean the filter, if necessary. Refer to "Care and cleaning".• Adjust manually the items in the tub and start the spin phase again. This problem may be caused by balance problems.

Problem	Possible solution
There is water on the floor.	<ul style="list-style-type: none"> • Make sure that the couplings of the water hoses are tight and there is not water leakages. • Make sure that the water inlet hose and the drain hose have no damages. • Make sure you use the correct detergent and the correct quantity of it. • Too much detergent or unsuitable detergent creates too much foam. Reduce detergent quantity and/or use a suitable detergent.
You cannot open the appliance door.	<ul style="list-style-type: none"> • Make sure that a washing programme that ends with water in tub, has not been selected. • Make sure that the washing programme is finished. • Set the drain or the spin programme if there is water in the drum. If the spin and drain programmes are not available in the programme dial, they can be set via App. • Make sure that the appliance receives electrical power. • This problem may be caused by a failure of the appliance. Contact the Authorised Service Centre. If you need to open the door, please read carefully "Emergency door opening". • Make sure that the Remote Start Mode is not activated. Deactivate it.
The display does not show the wireless indicator  .	<ul style="list-style-type: none"> • Check the wireless signal. • Make sure that the wireless connection is on. Refer to paragraph "Configuring the washing machine wireless connection" in "Wi-Fi - Connectivity setup" chapter. • Check your home network and router. • Restart the router. • Contact your wireless service provider if there are further problems with the wireless network.
The App cannot connect to the appliance.	<ul style="list-style-type: none"> • Check the wireless signal. • Check if your smart device is connected to the wireless network. • Check your home network and router. • Restart the router. • Contact your wireless service provider if there are problems with the wireless network. • The appliance, the smart device, or both, need to be configured again because a new router has been installed or the router configuration has been changed.
The App cannot frequently connect to the appliance.	<ul style="list-style-type: none"> • Make sure that the wireless signal reaches the appliance. Try to move the home router as near the appliance as possible or consider purchasing a wireless range extender. • Make sure the wireless signal is not disrupted by microwave. Turn the microwave off. Avoid using the microwave and the remote control at the same time.
The display shows  . All buttons are inactive, except the the On/Off  .	<ul style="list-style-type: none"> • The appliance is downloading any available updates. Wait until the update process is complete. If you deactivate the appliance during update, it resumes when you activate the appliance again.

Problem	Possible solution
The appliance makes an unusual noise and vibrates.	<ul style="list-style-type: none"> • Make sure the levelling of the appliance is correct. Refer to "Installation instruction". • Make sure that the packaging and/or the transit bolts are removed. Refer to "Installation instruction". • Add more laundry in the drum. The load may be too small.
The programme duration increases or decreases during programme execution.	<ul style="list-style-type: none"> • The ProSense Technology is able to adjust the programme duration according to the type and the laundry load size. Refer to "The ProSense Technology load detection" in "Daily Use" chapter.
The washing results are not satisfactory.	<ul style="list-style-type: none"> • Increase the detergent quantity or use a different detergent. • Use special products to remove the stubborn stains before you wash the laundry. • Make sure that you set the correct temperature. • Decrease the laundry load. • When using AutoDose tanks, make sure that they are not empty. • When using AutoDose tanks, verify the pre-set detergent/fabric softener dosage. Refer to "Basic setting" paragraph in "The AutoDose Technology" chapter. • Make sure that you have cleaned the AutoDose tanks before using different brand and type of detergent, fabric softener or other additives.
Too much foam in the drum during the washing cycle.	<ul style="list-style-type: none"> • Reduce the quantity of detergent or the number of tablets or single-dose detergents. • When using AutoDose tanks, verify the pre-set detergent/fabric softener dosage. Refer to "Basic setting" paragraph in "The AutoDose Technology" chapter. • Too much detergent or unsuitable detergent has been used. Reduce detergent quantity and/or use a correct detergent.
The detergent/fabric softener level does not decrease in the AutoDose tanks after washing.	<ul style="list-style-type: none"> • This is normal: tanks are quite large and detergent consumption may be not so evident.
The drum light does not go on.	<ul style="list-style-type: none"> • Make sure that the LED lamp is not burned. To replace it, contact the Authorised Service Centre.

After the check, activate the appliance. The programme continues from the point of interruption.

If the problem occurs again, contact the Authorised Service Centre. The necessary data for the service centre are on the rating plate.

15.2 Emergency door opening

In case of power failure or functioning failure the appliance door remains locked. The washing program continues when the power is restored. If the door remains locked in case of failure, it is possible to open it using the emergency unlock function.

Before opening the door:



CAUTION!

Risk of burns! Make sure that the water temperature is not too high and the laundry is not hot. If necessary, wait until they cool down.

⚠ CAUTION!

Risk of injury! Make sure that the drum is not rotating. If necessary, wait until the drum stops rotating.



Make sure that the water level inside the drum is not too high. If necessary, proceed with an emergency drain (refer to «Emergency drain» in «Care and cleaning» chapter).

To open the door, proceed as follows:

1. Press the On/Off button to switch the appliance off.
2. Disconnect the mains plug from the mains socket.
3. Open the filter flap.

4. Pull the emergency unlock trigger downward once. Pull it downward once again, keep it tensed and, in the meanwhile, open the appliance door.

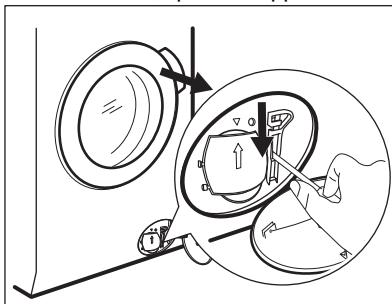

5. Take out the laundry and then close the appliance door.
6. Close the filter flap.

16. QUICK GUIDE

16.1 Daily use

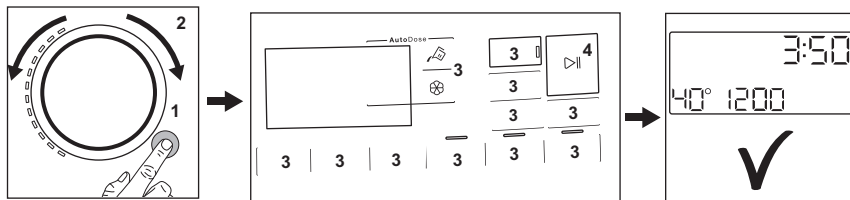

- Connect the mains plug to the mains socket.
- Open the water tap.
- Push the **On/Off** button to turn the appliance on (1).
- Turn the program dial to set the desired program (2).
- Set the desired options by means of the corresponding touch buttons (3).
- Put the laundry in the drum, one item a time without exceeding the maximum suggested load. Close the door and make sure that no laundry stays between the seal and the door.
- **When using AutoDose tanks**, the detergent and fabric softener are uploaded

automatically. Make sure that tanks are not empty.

When using manual compartments, pour the detergent and other treatments in the proper compartment.

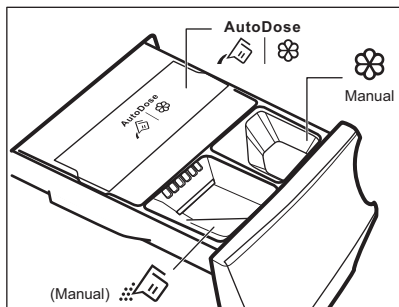

i
When using a liquid detergent in manual compartment, insert the container for liquid detergent.

- To start the program, touch the **Start/Pause** button (4), Confirm LED starts blinking until Confirm Start button is pressed.
- The appliance starts.
- At the end of the program, remove the laundry.
- Push the **On/Off** button to turn the appliance off.

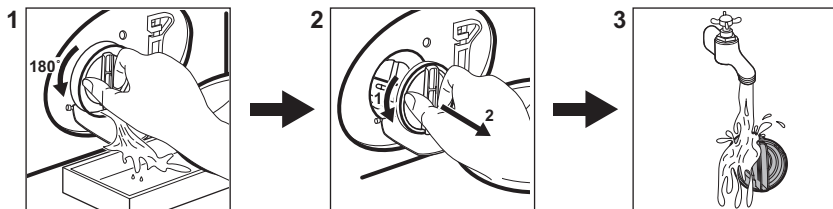

16.2 Cleaning the drain pump filter



Clean the filter regularly and, especially, if the alarm code **E2** appears on the display.

16.3 Programs

Programmes	Load	Product description
PowerClean 59min	5.0 kg	Cotton and synthetic items. This programme ensures a good washing performance in a short time.
Cottons Eco	10.0 kg	White cotton and coloured cotton. Normally, heavily and lightly soiled items. The Cottons Eco program at 40 °C is recommended for a normally soiled full load of cotton and is the water and energy rating label program in accordance with AS/NZS2040 and AS/NZS6400.
Cottons	10.0 kg	White and coloured cotton fabrics. Ideal for normal and heavy soil.
Synthetics	4.0 kg	Synthetic items or mixed fabric items.

Programmes	Load	Product description
Delicates	2.0 kg	Delicate fabrics such as acrylics, viscose, polyester items.
 Wool	2.0 kg	Machine washable wool, hand washable wool and delicates.
20min 3kg	3.0 kg	Cotton and synthetic lightly soiled items or once worn items.
 Steam	1.0 kg	Cotton and synthetic items that need to de-wrinkle.
Bedlinen XL	2.0 kg ¹⁾ 1.0 kg ²⁾	Washing cycle for three bedlinen sets, one of which can be double size.
 Hygiene	10.0 kg	White cotton items. This programme removes more than 99,99% of bacteria and viruses ³⁾ . It also ensure a proper reduction of allergens.
Rinse	10.0 kg	All fabrics, except woollens and very delicate fabrics. Programme for rinsing and spinning.
Spin/Drain	10.0 kg	To spin the laundry and to drain the water in the drum. All fabrics, except woollens and delicate fabrics.

1) Washing program.

2) Washing program and waterproofing phase.

3) Tested for Staphylococcus aureus, Enterococcus faecium, Candida albicans, Pseudomonas aeruginosa and MS2 Bacteriophage in external test performed by Swissstest Testmaterialien AG in 2021 (Test Report No. 202120117).

16.4 Detergent type and quantity.

- Use only detergents and other treatments specially made for washing machines. First, follow these generic rules:
 - powder detergents (also tablets and single-dose detergents) for all types of fabric, excluding delicate. Prefer powder detergents containing bleach for whites and laundry sanitization,
 - liquid detergents (also single-dose detergents), preferably for low temperature wash programmes (60 °C max) for all types of fabric, or special ones for woollens only.
- Do not mix different types of detergents.
- Use less detergent if:
 - you are washing a small load,
 - the laundry is lightly soiled,
 - there is large amounts of foam during washing.

- When using detergent tabs or pods, always put them inside the drum, not in the detergent dispenser and follow the manufacturer's recommendations.

Insufficient detergent may cause:

- unsatisfactory washing results,
- the wash load to turn grey,
- greasy clothes,
- mould in the appliance.

Excessive detergent may cause:

- sudsing,
- reduced washing effect,
- inadequate rinsing,
- a greater impact for the environment.

16.5 Periodic cleaning schedule

Periodic cleaning helps to extend the life of your appliance.

After each cycle, keep the door and the detergent dispenser slightly open to get air

circulation and dry the humidity inside the appliance.

If the appliance is not used for a long time: close the water tap and unplug the appliance.

Indicative periodic cleaning schedule:

Descaling	Twice a year
Maintenance wash	Once a month
Clean door seal	Every two months
Clean drum	Every two months
Clean detergent dispenser and AutoDose tanks	Twice a year
Clean drain pump filter	Twice a year
Clean the inlet hose and the valve filter	Twice a year

Regularly examine the drum to check for limescale. We recommend to run a cycle with empty drum and a descaling product occasionally.

Removing foreign objects



Make sure that pockets are empty and all loose elements are tied up before running your cycle.

Remove any foreign objects (such as metal clip, buttons, coins, etc) that you may find in the door seal, the filters and the drum. If necessary, please contact the Authorised Service Centre.

Door seal

This appliance is designed with a **self cleaning draining system**, allowing light fluff fibers that fall off the clothes to be drained out with the water. Regularly examine the seal and if necessary clean as described in the following diagram. Coins, buttons, other small items can be recovered at the end of the cycle.

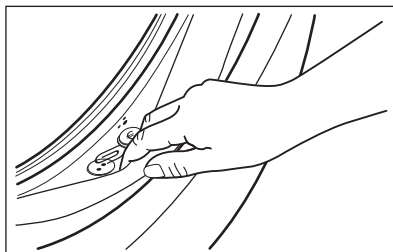

Clean it when needed, using ammonia cream cleanser agent without scratching the seal surface.

If it is necessary, remove fluff and objects from the filter recess.

16.6 Wi-Fi - Connectivity setup

This chapter describes how to connect the smart appliance to the Wi-Fi network and to link it to mobile devices.

By this functionality you can receive notifications, control and monitor your appliance from your mobile devices.

The Wi-Fi functionality is off as factory default setting.

To connect the appliance to enjoy the full range of features and services you need:

- Wireless network at home with internet connection enabled.
- Mobile device connected to wireless network.

Frequency	2.4 GHz according to local country regulation
Protocol	IEEE 802.11b/g/n
Max power	According to local country regulation
Encryption	WPA, WPA2, WPA3



Minimum requirements: Operating system compatibility iOS 15/Android 7.1 and above. Install the AEG App, create an account and accept the Terms and Conditions and AEG Privacy Policy to use the connected features. Stable Internet and good Wi-Fi connection with 2.4GHz wireless frequency is required. Minimum requirements, apps and services are subject to change without notice.

Configuring the appliance wireless connection

1. Press the On/Off button for a few seconds to activate the appliance. Wait about 10 seconds before proceeding with wireless configuration.
2. Select a programme by turning the programme dial.
3. Press and hold the Remote Start button for a few seconds until a 'click' sounds. Release the button. *On* appears on the display for 5 seconds and the indicator starts blinking. The wireless module begins starting up.



Make sure that you APP is ready for connection.

4. After about 10 seconds, (**Access Point**) appears on the display.

The access point will be open for about 5 minutes.

5. Configure the AEG App on your smart device and follow the instructions to connect the appliance to your Wi-Fi network.
6. If the connectivity is configured, when the programme information screen returns, the indicator is on the display.



Every time you switch the appliance on, the appliance takes about 10 seconds to connect to the network automatically. When the indicator stops blinking the connection is ready.

To switch the wireless connection off, press and hold the Remote Start button for a few seconds until the first acoustic signal. Release the button. *OFF* appears on the display for 5 seconds.



If you switch the appliance off and on again, the wireless connection is automatically off.

To remove the wireless credentials, press and hold the Remote Start button for a few seconds until the second acoustic signal sounds. Symbol appears on the display for a few seconds.

17. ENVIRONMENTAL CONCERNS

Recycle materials with the symbol . Put the packaging in relevant containers to recycle it. Help protect the environment and human health by recycling waste of electrical and electronic appliances. Do not dispose of

appliances marked with the symbol with the household waste. Return the product to your local recycling facility or contact your municipal office.







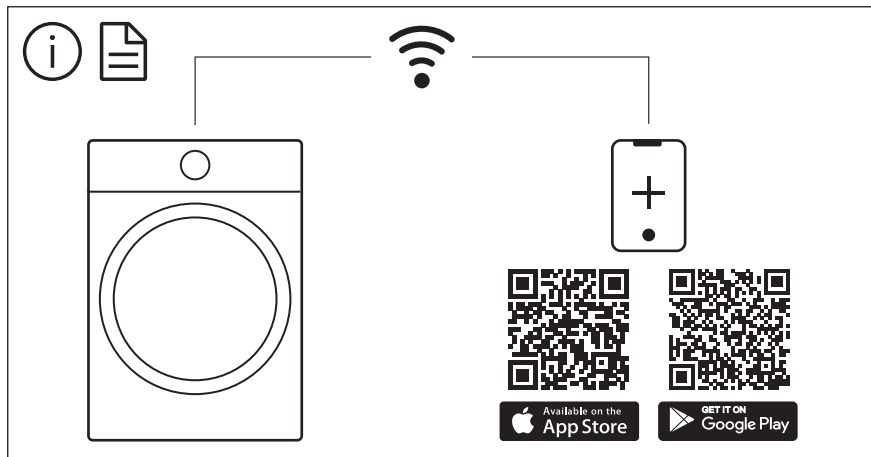

The software in this product contains components that are based on free and open source software. AEG gratefully acknowledges the contributions of the open software and robotics communities to the development project.

To access the source code of these free and open source software components whose license conditions require publishing, and to see their full copyright information and applicable license terms, please visit:
<http://aeg.opensoftwarerepository.com> (folder NIUS)