

RANGE COOKERS

MAJESTIC - PANORAMAGIC - NOSTALGIE - PRO LINE
PROFESSIONAL PLUS 06 - 07 - 09 - 30 - 10 - 12 - 15

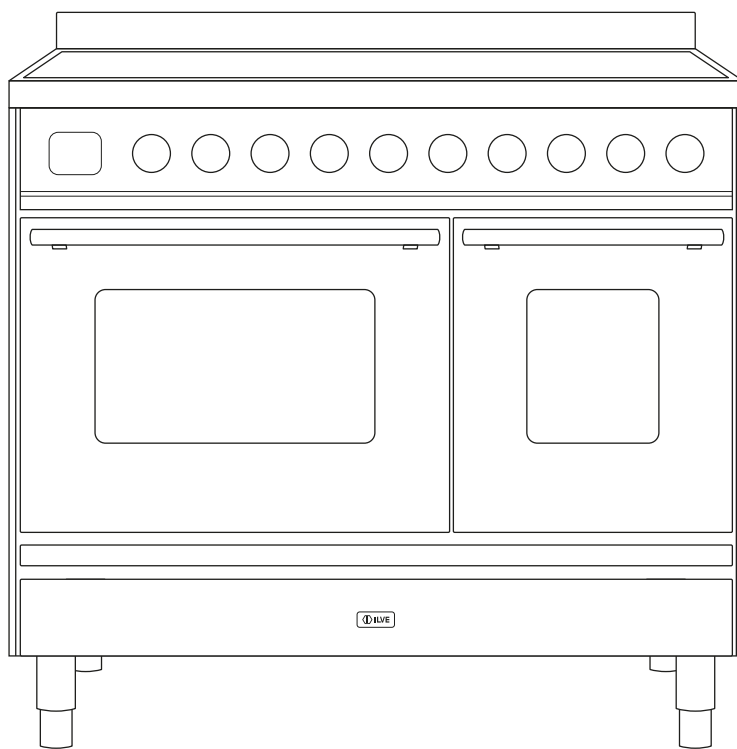

EN | User manual

IMPORTANT SAFETY WARNINGS



Appliances' data

The label with the technical characteristics, in addition to being printed on the cover, is applied to the door frame of the oven and is visible when the door is open.

WARNING! These warnings apply to different types of appliances. Be sure to correctly identify the type you own (see the technical label). These warnings are valid for the countries listed on the label.

1. Before using the appliance, carefully read the instruction manual, which contains, among other things, very important information regarding safety during installation, use, and maintenance. Keep the instruction manual safe for future reference and for identifying the serial number.
2. The electrical safety of this appliance is guaranteed only if the correct grounding connection is made as required by current regulations. It is essential to ensure that these regulations have been followed; if in doubt, contact a qualified person to thoroughly check the electrical system. The manufacturer assumes no responsibility for damage caused by a faulty grounding system.
3. Before connecting the appliance, ensure that the technical characteristics on the label match those of the electrical system. Installation/adjustment must be carried out by qualified personnel.
4. Ensure that there is enough air circulation around the appliance. This appliance is not connected to a combustion product evacuation system, so special attention must be paid to the ventilation of the room, in accordance with the applicable installation standards.
5. Using a gas cooking appliance generates heat and humidity in the room where it is installed. Ensure proper ventilation in the kitchen: keep natural ventilation openings open or install a mechanical ventilation device (such as an extractor hood). Intense and prolonged use of the appliance may require additional ventilation, such as opening a window or increasing the power of the mechanical extractor if available.
6. The power cord does not come with a plug. For connections, see the "Electrical Connection" section. It is recommended not to use adapters, multiple outlets, or extensions.
7. For direct connection to the network, a device must be provided that ensures disconnection from the network, with contact opening distances allowing complete disconnection under overvoltage category III conditions, in compliance with installation rules.
8. The appliance should not be installed on a pedestal.
9. When the appliance is unused for an extended period, disconnect the power supply, turn off the main switch, and close the gas supply.
10. Do not obstruct the air vents or heat dissipation openings.
11. If the power cord is damaged, it must be replaced by the manufacturer, its authorized service center, or by a qualified person with similar qualifications, in order to prevent any risks.
12. The damaged power cable of the appliance must only be replaced by an authorized service provider from the manufacturer.
13. The appliance should only be used for its intended purpose (cooking). Any other use (e.g., heating a room) is improper and thus dangerous. The manufacturer disclaims any responsibility for damages caused by such improper uses.
14. The appliance is not intended to be operated via an external timer or a separate remote control system.
15. Using any electrical appliance requires adherence to some basic rules:
 - Never touch the appliance with wet or damp hands or feet.
 - Never use the appliance barefoot.
 - Avoid using extension cords and, if necessary, take all possible precautions.
 - Never pull the power cord to unplug it.
 - Do not expose the appliance to weather conditions (rain, sun, etc.).
 - Attention: Accessible parts may become very hot during use. Keep children under 8 years old away from the appliance unless constantly supervised. This appliance can be used by children aged 8 and older and by people with reduced physical, sensory, or mental capabilities or lack of experience and knowledge, provided they are under adequate supervision or have been instructed on the safe use of the appliance and understand the associated dangers. Children must not play with the appliance. Cleaning and maintenance must not be carried out by children without supervision.
16. Warning: Some accessible parts of the facade, grill, and griddle may become very hot during use: keep children away.
17. During use, the appliance heats up considerably. Never touch the internal elements of the oven.
18. Before cleaning the appliance or performing maintenance, disconnect the appliance by unplugging it or turning off the electricity via the appropriate switch.
19. In case of malfunction or poor performance, turn off the appliance, close the gas valve, and do not attempt any repairs. Repairs must be carried out exclusively by an authorized service center. Always insist on using original replacement parts. Failure to follow these instructions may compromise the appliance's safety.
20. Do not place unstable or deformed pots on the burners or electric plates as they may accidentally tip over.
21. Ensure that when the appliance is not in use, the knobs are exactly in the "●"/"○" position.
22. Do not leave the cooking plate on without pots, as it will quickly reach the maximum temperature, potentially damaging the appliance or surrounding furniture.
23. Some parts of the appliance, particularly electric plates, remain hot for a long time after use. Be careful not to touch them.
24. Do not use flammable liquids (alcohol, gasoline, etc.) near the appliance when it is in operation.

IMPORTANT SAFETY WARNINGS

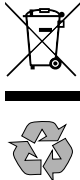

25. If small appliances are used near the cooking surface, be careful to avoid the electrical cord touching the hot parts of the appliance.
 26. Gas appliances must be installed in well-ventilated rooms. Therefore, ensure that the installation complies with the instructions in the "Installation" section.
 27. The materials used to construct this appliance are environmentally friendly and recyclable. Packaging waste should not be left within reach of children but should be disposed of using appropriate recycling channels. For the disposal of your appliance, use the disposal options provided by your retailer and/or local municipality; remember to make the appliance unusable before disposal.
- 
28. In case the rotation of the gas taps is stiff or faulty, do not attempt any operation on the tap. Close the gas supply and contact the authorized service center.
 29. Do not use steam cleaners for the internal cleaning of the oven.
 30. Do not use abrasive cleaners or sharp metal tools to clean the oven door glass, as they may damage the surface and cause it to break.
 31. Do not modify or alter the appliance.
 32. To prevent overheating, do not install the appliance behind decorative doors.
 33. Use only the recommended meat thermometer for this oven.
 34. Warning: Leaving the appliance unattended with objects, fats, and oils can be dangerous and may cause a fire.
 35. The appliance must be used by responsible personnel.
 36. Warning: The use of inappropriate or non-compliant protections may cause fires and/or damage.
 37. Warning: Automatic cooking with fats or oils may be dangerous and can cause fires.
 38. Warning: Fire hazard: Do not store objects on the cooking surfaces.
 39. Warning: In case of fire, never attempt to extinguish a flame/ fire with water. Instead, turn off the appliance and cover the flame with a lid or a fireproof blanket.
 40. Warning: Metal objects such as knives, forks, spoons, or lids should not be placed on top of the appliance as they may heat up.
 41. Warning: Do not use the gas burners if the flame is unstable.
 42. Ensure that the flame spreader crowns are correctly positioned in their seats with their respective caps.
 43. Do not leave the appliance unattended during cooking processes that may release fats or oils.
 44. Do not touch the heating elements of the appliance when in operation. Allow them to cool before attempting any cleaning.

45. Cooking food in plastic or aluminum containers on hot cooking zones is prohibited, as is placing plastic or aluminum foil objects on the cooking surface.
46. Do not apply aluminum foil sheets to cover the burners or cooking surface.
47. Do not use the appliance surface as a worktop; sharp objects may scratch it.
48. Cookware or grills must be placed within the perimeter of the cooking zone.
49. Warning: Do not use frying pans, pots, grills, or grilling stones that exceed the maximum size indicated for each individual burner; they should not cover multiple burners simultaneously. Heat accumulation could damage the appliance.
50. In the case of spillage or overflow, remove the excess liquid from the cooking surface.
51. Do not place empty pots on the cooking zones.
52. The cooking zones must not operate without cookware.
53. The oven door hinges can be damaged if too much weight is placed on them. Do not put heavy items on the open oven door, and avoid leaning on it while cleaning the inside of the oven. Never stand on the open oven door, and do not let children sit on it.

ATTENTION: Do not use the pyrolysis function before removing excess estimated residues during previous cooking.

DO NOT USE OR STORE FLAMMABLE MATERIALS IN THE APPLIANCE STORAGE DRAWER OR NEAR THIS APPLIANCE.

DO NOT SPRAY AEROSOLS IN THE VICINITY OF THIS APPLIANCE WHILE IT IS IN OPERATION.

DO NOT USE THIS APPLIANCE AS A SPACE HEATER.

DO NOT PLACE ARTICLES ON OR AGAINST THIS APPLIANCE.

DO NOT MODIFY THIS APPLIANCE.

THESE APPLIANCES ARE NOT SUITABLE FOR AFTERMARKET LIDS OR COVERS.

First use of the oven

- Warning: The surfaces of the heated drawer may become hot during operation. When using the oven for the first time, operate it empty for approximately 1 hour at 230°C, preferably keeping the kitchen windows open.
- When using the oven for the first time, operate it empty for approximately 1 hour at 230°C, leaving the kitchen windows open if possible. The oven may emit unpleasant odors due to production residues such as fats, oils, or resins. Once the oven has cooled, clean it following the instructions in the "Cleaning and Care of the Oven" section.
- After the indicated time has passed, the oven is ready for the first cooking use.

IMPORTANT SAFETY WARNINGS



- Do not cover the inside of the oven with aluminum foil to ease cleaning. This will affect the appliance's performance and may damage the enamel.
- All accessories that come into direct contact with food should be thoroughly cleaned before use using appropriate cleaning products.
- The appliance must be installed by authorized personnel. The installer is not responsible for any damage caused by errors in electrical connection.
- Metal objects such as knives, spoons, forks, or lids should not be placed on the hob surface as they may heat up.
- If the surface is cracked, turn off the appliance to prevent the risk of electric shock.
- Warning: The appliance is not designed to operate with an external timer or remote control system.
- Warning: Do not use steam cleaners to clean the hob.

Models with induction hob

Precautions before use

- The appliance must only be used for cooking food and not for any other domestic or industrial purposes.
- Remove any stickers from the glass of the hob.
- Do not modify or alter the appliance.
- Do not use the hob as a work surface.
- The appliance must be connected and installed in accordance with local regulations.
- Do not use extension cords for the connection.
- The appliance cannot be used with cookware that is not suitable for induction cooking.
- This appliance can be used by children aged 8 and above, and by persons with reduced physical, sensory, or mental capabilities, or by those without experience or knowledge, provided they are under adequate supervision or have been instructed in the safe use of the appliance and are aware of the associated dangers.
- Warning: This appliance and its accessible parts become very hot during use. Keep children under 8 years old away unless they are continuously supervised.

Use of the appliance

- After use, turn off the cooking zone using its control device and do not rely on the pan detection system.
- Warning: Leaving the appliance unattended with objects, fats, and oils can be dangerous and may cause a fire.
- Warning: In case of fire, never attempt to extinguish a flame/fire with water. Instead, turn off the appliance and cover the flame, for example, with a lid or a fireproof blanket.
- Cleaning and maintenance operations should not be carried out by children without supervision.
- Ensure that the power cable does not come into contact with the glass or the pot.
- Magnetic objects such as credit cards, floppy disks, calculators should not be placed near the appliance while in use.
- Do not use any metallic objects except cookware suitable for induction.
- Do not cover the cooking zone with flammable materials.
- The appliance must be used by responsible personnel.

Precautions to avoid damaging the appliance

- Inappropriate cookware may damage the surface of the hob.
- Do not use abrasive materials for cleaning.
- Avoid dropping heavy objects on the hob surface.
- Place pots gently on the hob.
- Ensure that the ventilation of the appliance complies with the instruction manual.
- Do not place empty pots on the hob.
- Sugar, synthetic materials, or aluminum materials should not come into contact with the cooking zones.
- Avoid placing hot containers on the display.

In case of malfunction

- In the event of a malfunction, turn off and disconnect the appliance.
- If the glass has cracks or breaks, disconnect the appliance and contact the authorized service center.
- Any repairs should be performed by authorized personnel.

Precautions

- Ensure that the pot is placed in the center of the cooking zone. Ideally, the bottom of the pot should cover the entire cooking zone.
- The magnetic field generated by the induction hob may affect the proper functioning of pacemakers. It is recommended to seek detailed information from a healthcare professional.
- Avoid contact with the cooking zones of synthetic materials or aluminum.

To keep the appliance efficient and safe, maintenance should be entrusted to specialized technicians or authorized service personnel. Choose cookware with lids based on the amount of food to be cooked.

INSTRUCTIONS FOR USE

Gas hob

Correct use of burners

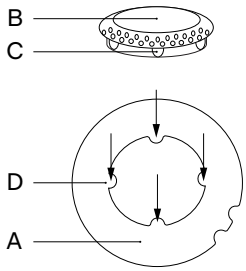

Correctly position the flame spreader "B". To do so, align the 4 teeth "C" of the flame spreader with the recess "D" of the aluminum cup "A"

Ignition of the burners

The index above the knobs will help you locate the corresponding burner. Press the knob while rotating it counterclockwise, preferably to the ignition position. At this point, the spark will ignite the burner; keep the knob pressed for about 5 seconds to ensure that the flame stays lit when released (if ignition fails, repeat the procedure).

Symbols	Function	Knob	DUAL (Only for certain models)
● ○ ○ ○ ○ ○	Index		
○	Off		
●	Maximum		
●	Minimum		
○ ● ○ ○ ○ ○	Index		
●	Off		
●	Maximum		
●	Minimum		

Ignition of the DUAL Burner (Only for certain models)

Identify the knob using the index near the knobs themselves. Press and rotate the knob to the (maximum) symbol for 5 seconds. Once the burner is lit, continue rotating the knob counterclockwise until you reach the first stop, which corresponds to the medium setting. By applying slight force, you can surpass the first stop, causing the outer flame ring to turn off, leaving only the small central burner, called the AUXILIARY burner, lit. To adjust the auxiliary burner to its minimum, rotate the knob counterclockwise until it reaches the end of its travel. At this point, to reignite the entire burner, rotate the knob clockwise to the desired setting.

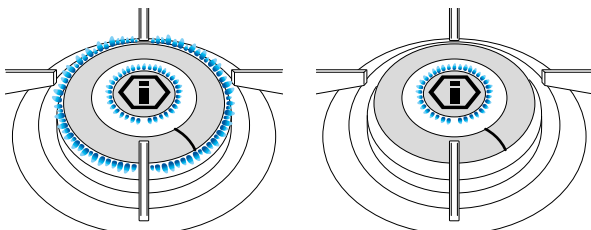

Cookware to use according to burner size

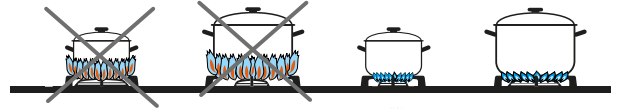

Burners	ID	Diametro fondo pentola Ø (cm)
Medium	SR	10 ÷ 20
Large	R	20 ÷ 24
Fish burner	P	Oval pans (380 x 185)
Ring	TC/DCC	22 ÷ 28
Dual ring	DUAL	24 ÷ 30

Burner Placement

⚠ Always check that the burners are correctly positioned, ensuring a uniform and quiet flame.

Burner	Right	Wrong
Semi-Rapid (Medium) Rapid (Large)		
Dual ring		
Fish burner Check that the screws under the burner are always properly tightened.		

INSTRUCTIONS FOR USE

Gas hob

Use of the griddle

If you wish to use a griddle, please keep the following precautions in mind:

- The griddle can be preheated at the maximum burner power for no more than 10 minutes.
- It is recommended to set the cooking power to a lower setting for food preparation.
- Ensure that the flames from the burner do not extend beyond the edge of the griddle.
- Maintain a minimum distance of 150 mm from the side wall to the edge of the griddle.
- Do not place the griddle on multiple burners simultaneously.

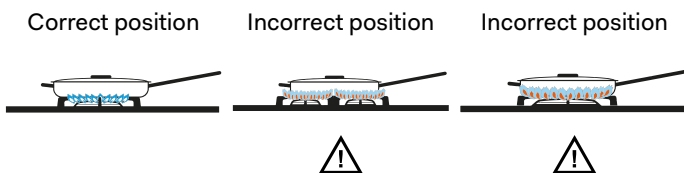

Use of the "coup de feu"

Functioning of the appliance

The large "Coup de Feu" cast iron plate with concentric rings allows you to place the container (or multiple containers) directly on the surface (fig. B, C). The heating is provided by a gas burner (fig. A). The plate is designed to provide heat that is not too intense and is evenly distributed across the surface. This allows for slow cooking, particularly suitable for sauces and gravies, browning and grilling, or for heating and keeping food warm. Switch on the burner 15/20 minutes before use to allow the cast iron plate to accumulate heat. The plate can then be used for another 10/15 minutes even with the burner turned off. The center of the plate is where the highest temperatures are reached, while the peripheral areas are cooler. By simply moving the container from the center to the outer areas, you can achieve varying cooking intensities without adjusting the flame. If the size of the containers allows, you can cook several dishes simultaneously (fig. C). When needed, it can also be used as a practical and spacious countertop.

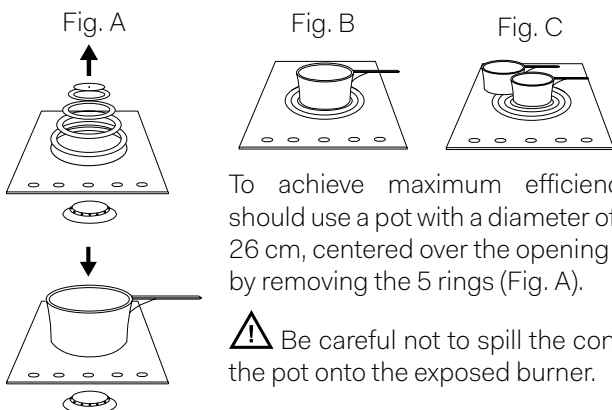

To achieve maximum efficiency, you should use a pot with a diameter of at least 26 cm, centered over the opening created by removing the 5 rings (Fig. A).

⚠ Be careful not to spill the contents of the pot onto the exposed burner.

Cleaning and maintenance

Cleaning should be done when the plate is warm, using common kitchen products for metal surfaces. Scrub with a steel wool pad, following the grain of the satin finish. Dry thoroughly and immediately. If you wish to improve the aesthetic appearance of the plate, after cleaning, apply a layer of Supercromo paste. If the plate will not be used for long periods, after the usual cleaning, apply a thin layer of liquid paraffin (vaseline oil) with a cotton ball. This treatment is necessary to prevent the formation of surface oxidation. Upon the next use of the plate, you may notice a slight evaporation of the paraffin oil, which will disappear within a few seconds. The plate may sometimes show signs of surface oxidation due to moisture or, more likely, because it has not been used for some time. It is recommended to use the plate regularly to prevent any oxidation. Never leave the plate wet. If surface oxidation occurs, use a slightly abrasive paper to remove it, being careful to scrub gently and always following the grain of the plate's satin finish.

Do not cook food directly on the surface of the plate.

Always use appropriate cookware.

Use of the gas fry-top

A = cooking zone

B = cooking fat collector

C = fry-top handles

D = spatula

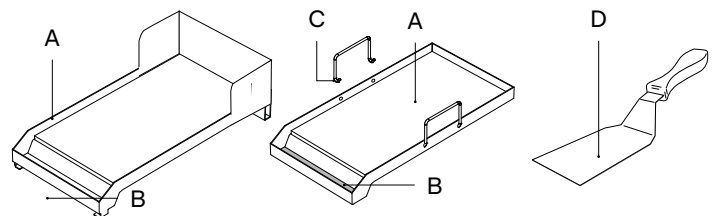

The fry-top consists of a stainless steel plate, suitable for contact with food [57] providing uniform temperature across the cooking surface with minimal heat loss. To use the appliance, ignite the flame underneath the plate by turning the corresponding knobs (see "Ignition of Burners") and ensure the flame is present. Set the knob to the maximum position for about 10 minutes and wait for the plate to heat up. After this period, the plate is ready to begin cooking. By adjusting the flame, you will have no limits to your culinary creativity. The lowest knob setting allows for slow or dietetic cooking, while faster cooking is ideal for meats, fish, and vegetables. The fry-top plate is also suitable for oriental dishes when used with an optional lid, which is necessary for this type of cooking. In some models, a spatula (D) is provided, which will help you both with cooking and cleaning the plate.

INSTRUCTIONS FOR USE

Gas hob

Cleaning and maintenance

It is recommended to perform a thorough cleaning at the end of each cooking session. With the plate still warm and the flame set to low, remove the cooking residues using the included spatula (D). Pour a small amount of water onto the plate and continue cleaning with the spatula. Once the water has completely evaporated, repeat the process several times until the desired result is achieved. It is extremely important to carry out the cleaning with the plate still hot.

Knob

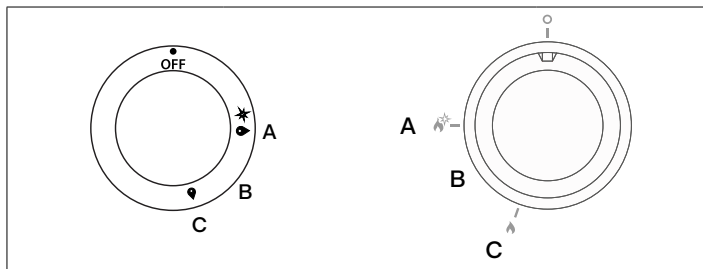
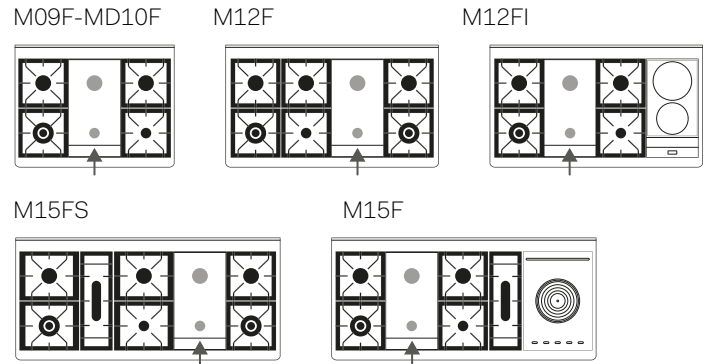

Plate	Knob position (A max - B med - C min)	Time min.
Egg	B	2
Eggplant sliced (thickness 0.5 cm)	B	5 - 9
Potatoes sliced	B	5 - 7
Zucchini sliced	B	5 - 9
Fish (sea bream, approx. 200 g)	B	15
Hamburger	B	9
Beef steak	B	2-3
Florentine steak (thickness 2 cm)	A	5

Correct positioning of the fry-top

Majestic



Panoramagic

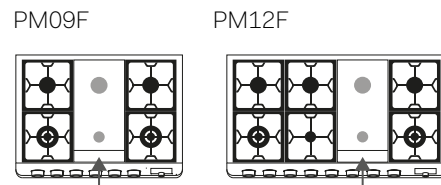

Professional Plus \ Nostalgie

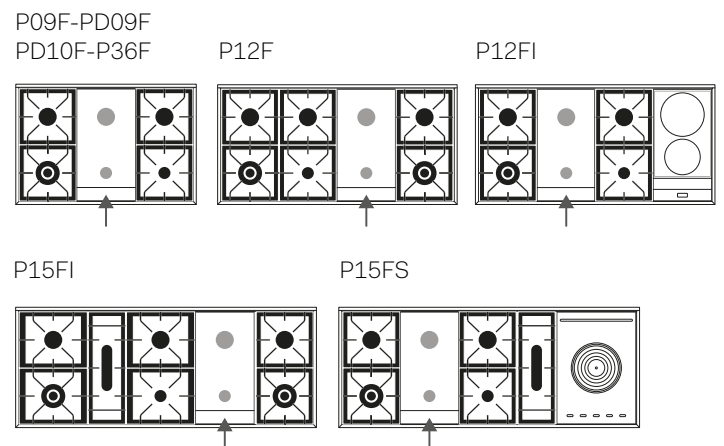

Pro Line

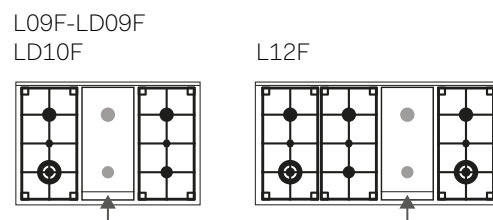

INSTRUCTIONS FOR USE

Induction hob

Induction cooking

Under each cooking zone, there is a coil that generates a variable electromagnetic field when a pot is placed on it, producing inductive power on a ferromagnetic material located at the bottom of the pot. The result is that the bottom of the pot heats up. The material that makes up the pot is crucial:

- Suitable pots are those with a ferromagnetic base (this can be checked with a magnet).
- The following types of pots should not be used: copper, stainless steel, aluminum, glass, wood, ceramic.

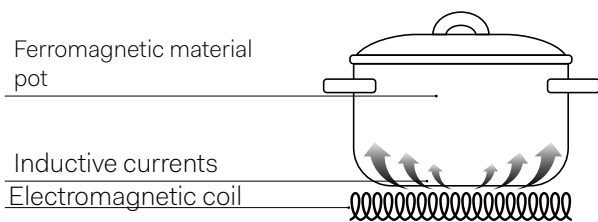

Recommended pots and zones

The heat zones are clearly indicated by the circular areas. When one or more cooking zones are used, the remaining surface stays cool. Each cooking zone is designed to work with induction-compatible pots, with a diameter slightly smaller than the diameter of the selected cooking zone. The bottom of the pot should be thick and flat. Its diameter should closely match the cooking ring's diameter. Both the cooking surface and the bottom of the pot should be kept clean.

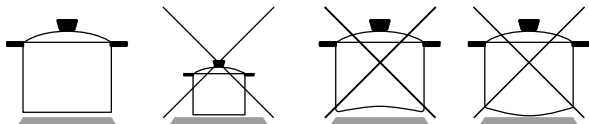

- Do not wet or overheat the plates.
- Avoid thermal shocks to the glass-ceramic top. For example, do not pour cold water onto the hot surface.
- Avoid extending the handles of pots as they may be accidentally knocked over.
- It is preferable not to cook on the glass-ceramic surface with pots that have been used on gas burners. The flame deforms the bottom of the pot.

Pots

Suitable Materials: Stainless steel, enameled steel, cast iron, ferromagnetic steel, aluminum with a ferromagnetic base.

Unsuitable Materials: Aluminum and steel without a ferromagnetic base, copper, ceramic, porcelain, glass, brass.

To check the compatibility of the pot, place it with a small amount of water on the cooking zone. Set the zone to level "9", and the water should boil in a few seconds.

Try using a magnet on the bottom of the pot.

Certain pots may generate "noise" during cooking. This phenomenon does not come from the induction hob and does not affect cooking performance.

Pot dimensions

The cooking zones automatically adjust to the diameter of the pots. However, the bottom of these pots must meet a certain minimum diameter for proper operation. To achieve maximum efficiency, place the pot at the center of the cooking zone.

Ventilation

La ventilazione del piano è completamente automatica. La ventilazione of the hob is fully automatic. The cooling fan for the electronics under the hob runs at low speed until the temperature of the electronics increases. When the hob is used for a longer time, the fan speed increases. Once the electronics are cool, the cooling fan will stop automatically.

After use, the glass-ceramic hob retains heat for an extended period. Do not leave children near the hob, and do not touch the surface with your hands. The residual heat indicator will remain on until the hob cools down.

In case the glass-ceramic hob develops cracks, immediately disconnect the appliance from the power supply and contact an authorized technical service center.

INSTRUCTIONS FOR USE

Induction hob

Use of the induction plate

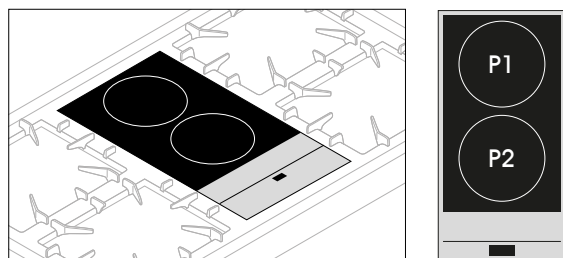

Zone	Diameter (mm)	Power (watt)
P1	ø 220	1850 W
P2	ø 180	1850 W

Display

- Power level set: (1-9)
- Heat-up: (A)
- Residual heat: (H)
- Pot missing or unsuitable (U)
- Error (E)

First power-on

Clean the surfaces of the hob with a damp cloth.

Turning on a cooking zone

Turn the corresponding knob clockwise. The set power level (from 1 to 9) will appear on the hob display.

Turning off a cooking zone

A cooking zone is turned off by rotating the corresponding knob counterclockwise. The display will show [0] for 15 seconds, after which it will disappear from the display or switch to the [H] symbol if the cooking zone is still hot.

Automatic shutoff

The appliance automatically turns off when there are overheating issues or power error conditions.

Pan detection

Each cooking zone is designed to work with specific induction-compatible cookware with a diameter smaller than that of the selected cooking zone. If the pan is unsuitable, the display will show the pan absence symbol "U," and the appliance will not function. It prevents the hob from turning on until a suitable pot is placed on the cooking zone or an induction-compatible pan is used. The pan detection lasts for 9 minutes. If no suitable cookware is placed on the cooking zone during this time, the zone will turn off.

The zone display changes from the symbol U to [-].

Residual heat indication

If the cooking zone, when turned off, is still very hot, the display will show the symbol "H."

HEAT-UP Function

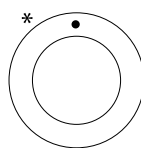

The Heat-up function is available on each cooking zone. This means that for a defined period of time, the cooking zone operates at maximum power, and once this time expires, the power is automatically reduced to the set level. The duration of this function depends on the set power level. The Heat-up function is activated by rotating the knob counterclockwise from the 0 position to the end stop, as shown in the figure. As soon as the knob is turned to the left, the display of the corresponding zone will show [A]. After activation, a power level must be set within 3 seconds for continued cooking; if this doesn't happen, the Heat-up function will be interrupted.

KEY-LOCK Function

The Key-lock function is useful in the presence of children. However, the presence of an adult is still recommended when the appliance is in use. Activating the Key-lock function turns off all cooking zones and prevents them from being accidentally turned on. The Key-lock function is activated, with the knobs in the 0 position, by rotating one of the induction zone controls counterclockwise. The display will show [L][L]. Repeating the same action will deactivate the Key-lock function.

Operation time limitation

Each cooking zone has its own maximum continuous operating time, which depends on the set power level. If the operation time limit is reached, the corresponding zone will turn off.

Level	Duration (hours)	Level	Duration (hours)
1	8.5	6	2.5
2	6.5	7	2
3	5	8	1.5
4	4	9	1.5
5	3.5		

Approximate power operation time limitation level.

Cooking tips (purely indicative values)

Knob position	Type of cooking
1 -2	Melt butter, chocolate, etc.
2 - 3	Heat small amounts of liquids, keep food warm, prepare sauces.
4 -5	Heat solid foods, defrost frozen foods, omelets with 2-3 eggs, fruits, and vegetables.
5-6	Cook meat and fish, legumes in sauce, dishes with water, prepare jams.
6-7	Roast meat or fish, steaks, liver, eggs.
8-9	Boil large quantities of water, fry potatoes, etc.

INSTRUCTIONS FOR USE

Induction hob

Use of induction hob

Mod. PI06

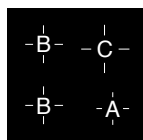

Mod. PDI10 - MDI10 - PI096 - MI096 - PDI096 - PMI09

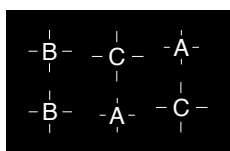

Mod. LBI095 - LDBI09

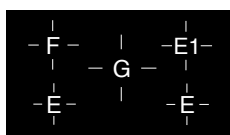

Mod. PI127 - MI127 - PMI12

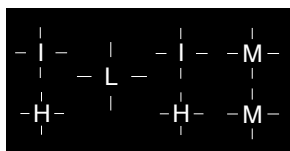

Zone	Diameter (mm)	Power (watt)	Booster (watt)
A	∅ 145	1400W	2200W
B	∅ 180	1850W	3000W
C	∅ 210	2300W	3700W
D	∅ 260	2600W	3700W
E	∅ 160	1100W	1400W
E1	∅ 160	1400W	2000W
F	∅ 200	2300W	3000W
G	∅ 250	2300W	3000W
H	∅ 145	1400W	1850W
I	∅ 200	2300W	3000W
L	∅ 250	2300W	3000W
M	210X190	2100W	3000W

First power-on

Clean the surface of the hob with a damp cloth.

Knob

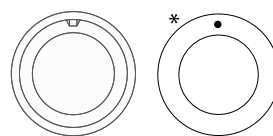

The knob has no markings, and the power level will be visible on the display.

Display

Each cooking zone is associated with its own display

- Set power level: (1-9)
- Food heating (42°-65°): (U)
- Booster: (P)
- Heat-up: (A)
- Residual heat: (H)
- Pot missing or unsuitable: (U)
- External error: (E)
- Fault: (F)
- Permanent knob rotation: (┘)

Turning on a cooking zone

Turn the corresponding knob clockwise. The set power level (from 1 to 9) will appear on the hob display.

Turning off a cooking zone

A cooking zone is turned off by rotating the corresponding knob counterclockwise. The display will show [0] for 15 seconds, after which it will disappear from the display or change to the [H] symbol if the cooking zone is still hot.

Automatic shutoff

The appliance automatically turns off when overheating conditions or power errors occur.

Pan detection

Each cooking zone is designed to work with specific induction-compatible cookware with a diameter just smaller than that of the selected cooking zone. If the pan is unsuitable, the display for that zone will show the "pot missing" symbol [U], and the appliance will not operate. This prevents the hob from turning on until a suitable pot is placed on the cooking zone or until an induction-compatible pan is used. If the pot is removed during operation, the zone will turn off. The pan detection lasts for 10 minutes; if no suitable pot is used on the cooking zone during this time, the zone will turn off. The zone display changes from the [U] symbol to the [-] symbol.

INSTRUCTIONS FOR USE

Induction hob

BOOSTER Function

The Booster function is used to provide additional power to a specific cooking zone in order to reduce the cooking time. This function is activated by rotating the knob clockwise from the 0 position (off) to the end stop. After a brief audible signal, the display will show [P], indicating that the Booster function is activated. The Booster function lasts a maximum of 10 minutes. After this time, the zone will automatically return to power level [9]. The Booster function ends before the time limit when:

- A lower power level is set.
- The pan is removed.
- An overheating condition occurs in the appliance or the cooking zone.

The Booster function takes priority over the Heat-up function.

HEAT-UP Function

The Heat-up function, or fast heating, is available on every cooking zone. This means that for a defined period, the cooking zone operates at maximum power, and once the time expires, the power is automatically reduced to the set level. The duration of this function depends on the set power level. The Heat-up function is activated by rotating the knob counterclockwise for 2 seconds, from the 0 position, to the end stop. After a brief audible signal, the display for the corresponding zone will show [A]. After activation, a power level must be set within 10 seconds to continue cooking; if this does not happen, the Heat-up function will be interrupted.

BRIDGE Function

Place the pot in the center of the B+B or M+M zones (see page 26). Rotate both knobs of the two involved zones clockwise beyond the end stop for 3 seconds, and the Bridge function will be activated.

After activation, the power for both zones can be adjusted using only the left knob.

Note: The pot used must have a size that covers both centers of the two zones.

KEEP WARM 42° and 65° Functions

Rotate knob clockwise. Between the off position (0) and the power position (1), there is the position (u), which activates the function to keep food warm inside the pot at 42°C.

For 5 and 6-zone models only: Rotate knob further clockwise. Between position "u" and the power position (1), there is position "U", which activates the function to keep food warm inside the pot at 65°C. The maximum time for both functions is limited to 120 minutes. Both functions take priority over the Heat-up function.

KEY-LOCK Function

The Key-lock function is useful when there are children present. However, the presence of an adult is still recommended when the appliance is in operation. Activating the Key-lock function turns off all cooking zones and prevents them from being accidentally turned on. Repeating the same action will deactivate the Key-lock function.

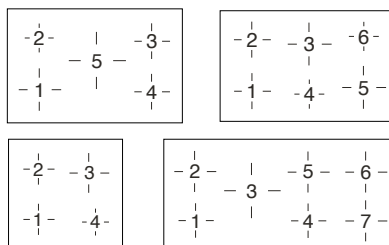

- **4-zone models:** The Key-lock function is activated, with the knobs in the 0 position, by rotating the controls for zones 2 and 3 counterclockwise. Repeating the same action will deactivate the Key-lock function. The display will show [O][F]. If a control is rotated with the Key-lock function active, the display will show [L][L][L][L].
- **5 or 6-zone models:** The Key-lock function is activated, with the knobs in the 0 position, by simultaneously rotating the controls for zones 1 and 2 counterclockwise. The display will show [L][L][L][L].
- **7-zone models:** The Key-lock function is activated, with the knobs in the 0 position, by simultaneously rotating the controls for zones 1, 2, 6, and 7 counterclockwise. The two displays will show .

Operation time limitation

Each cooking zone has a maximum continuous operating time. This depends on the set power level. If the operation time limit is reached, the corresponding zone will turn off.

Level	Duration (ore)
U	2
1	6
2	6
3	5
4	5
5	4
6	1,5
7	1,5
8	1,5
9	1,5
P	(10 min. [P], afterwards 80 min. [9])

INSTRUCTIONS FOR USE

Induction hob

Power management

Power management, when the Booster function is used, is carried out as follows: the most recent set cooking level takes priority over the other zones. The activation of a cooking zone will not be displayed if a power level that is too high is requested. In this case, the regular operation will only begin after reducing the power level by rotating the knob of the cooking zone counterclockwise, and the corresponding power level will then be shown on the display.

Overheating of the cooking zone

If a cooking zone overheats excessively during operation, the power will be automatically reduced, and the display will show the newly adjusted power level. At this point, only the power level can be decreased. Once the temperature of the cooking zone drops below the critical value, normal cooking can be resumed.

Recommended cooking programs (purely indicative values)

knob position	Type of cooking
1 - 2	Melt butter, chocolate, etc.
2 - 3	Heat small amounts of liquids, keep food warm, prepare sauces.
4 - 5	Heat solid foods, defrost frozen foods, omelets with 2-3 eggs, fruits, and vegetables.
5 - 6	Cook meat and fish, legumes in sauce, dishes with water, prepare jams.
6 - 7	Roast meat or fish, steaks, liver, eggs.
8 - 9	Boil large quantities of water, fry potatoes, etc.

MODELS	A ø145	B ø180	C ø210	D ø260	E ø160	E1 ø160	F ø200	G ø250	H ø145	I ø200	L ø250	M 210x190	E03E	E03	E04E	E06E3	O6MP	O9E3	O9MP	PM09	WD	kW QuickStart
PI06	1	2	1	-	-	-	-	-	-	-	-	-	-	-	-	1	-	-	-	-	-	10,60
LBI095...	-	-	-	-	2	1	1	1	-	-	-	-	-	-	-	-	-	1	1	-	-	10,8
M1096E3 ...	2	2	2	-	-	-	-	-	-	-	-	-	-	-	-	-	-	1	-	-	-	14,5
M1096S3 ...	2	2	2	-	-	-	-	-	-	-	-	-	-	-	-	-	-	1	-	-	1	15,1
PI096E3...	2	2	2	-	-	-	-	-	-	-	-	-	-	-	-	-	-	1	-	-	-	14,5
LBI09...	-	-	-	-	2	1	1	1	-	-	-	-	-	1	-	-	1	-	-	-	-	12
PI096E3...	2	2	2	-	-	-	-	-	-	-	-	-	1	-	-	1	-	-	-	-	-	16,6
MD110S3 ...	2	2	2	-	-	-	-	-	-	-	-	-	1	-	-	1	-	-	-	-	1	17,2
PI127 ...	-	-	-	-	-	-	-	-	-	2	1	2	1	-	-	-	-	1	-	-	-	19,85
M1127E3 ...	-	-	-	-	-	-	-	-	-	2	1	2	1	-	-	-	-	1	-	-	-	-
M1127S3 ...	-	-	-	-	-	-	-	-	-	2	1	2	1	-	-	-	-	1	-	-	-	-
PM109...E3	2	2	1	-	-	-	-	-	-	-	-	-	-	-	-	-	-	-	-	1	-	14,50
PM109...S3.	2	2	1	-	-	-	-	-	-	-	-	-	-	-	-	-	-	-	-	1	1	15,1
PM1127 ...	-	-	-	-	-	-	-	-	2	2	1	2	1	-	-	-	-	1	-	-	-	20,45

INSTRUCTIONS FOR USE

MP/M3 models with 5-button programmer

Description of standard oven controls

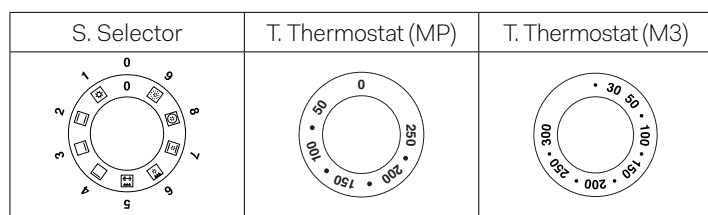

S - Electric Multifunction Oven Selector

P - Programmer - Clock - Timer

T - Thermostat

Use of thermostat (T)

This knob allows you to select temperatures from 50°C to 250°C (MP) and from 30°C to 300°C (M3).

Turning on and off

Select one of the cooking functions by rotating the selector (S) and adjust the temperature with the thermostat (T).

It is recommended to preheat the oven before baking.

Safety thermostat

The oven is equipped with a safety thermostat that disconnects the electrical supply. The thermostat resets automatically when the oven temperature drops. To reuse the oven, simply wait for it to cool down. If the thermostat is triggered due to a component malfunction, technical assistance should be contacted.











How to use the multifunction oven

Choose one of the 9 cooking functions by rotating the selector (S) and adjust the temperature with the thermostat (T). If your model has a programmer, set it for cooking.

Oven light

To turn the light on or off, apply a slight pressure to the selector knob (S). The light does not work if the selector is in the (0) position.

Functions

1		Pizza cooking This function is particularly suitable for cooking pizza, focaccia and bread. The main source of heat is from the bottom heating element that works in combination with the oven's other resistances.
2		Normal static cooking Is the oven's classic function particularly suited to cooking the following foods: pork chops, sausages, cod, braised beef, game, roast veal, meringues and biscuits, baked fruit, etc.
3		Cooking from underneath This is the most suitable form to finish food cooking, in particular confectionery (biscuits, meringues, leavened cakes, fruit desserts, etc.) and other foods.
4		Cooking from above Especially suitable for browning and to give the final touch of colour to many foods; it is recommended for hamburgers, pork chops, veal steaks, sole, cuttlefish, etc.
4a		Eco cooking (M3) It is the function that allows you to cook with a considerable saving on electricity consumption. To make the most of this feature it is useful, before inserting the ECO function, to introduce the dish inside the oven, positioning it in the center of the cavity. With the Eco function, cooking times adapt to slow cooking such as: braised meats, white meats, baked pasta, delicate pastries. This cooking cycle is not recommended for frozen foods. To select Eco cooking turn the selector knob "S" to position 8 and then, when the word "ON" appears on the display, hold down the "+" key of the programmer for about 2 seconds until the display shows the message "ECHO". With Eco cooking the programmable temperature ranges from a minimum of 30 ° C up to a maximum of 300 ° C. Note: Eco cooking cannot be selected with the meat probe inserted.
5		Closed door grill cooking The suitable function for fast and deep grilling, to brown and roast meats in general, fillet steaks, Florentine steaks, grilled fish and also grilled vegetables. Cooking with the electric grill must be made with the thermostat at 180 °C closed door.
6		Fan grill cooking Particularly fast and deep with significant energy savings, this function is suitable for many foods such as pork chops, sausages, pork or mixed spits, game, gnocchi alla romana, etc. Cooking with the electric grill must be made with the thermostat at 180 °C closed door.
7		Intensive cooking Is the quick and intense cooking function for various dishes; best for: baked fish, braised vegetables, spits, duck, chicken, etc.
8		Multiple fan cooking Is the function that allows simultaneous cooking of different dishes without the smells blending; you can cook lasagne, pizza, croissants and brioches, tarts, cakes, etc.
9		Quick Start This function is used to speed up the preheating of your oven. We suggest you use this function when setting a cooking temperature between 200 and 250 ° C. Using the QuickStart function for temperatures below 200 ° C does not offer particular advantages. To use the Quick Start function, turn the selector knob (S) until it is positioned on the symbol (9), then set the desired temperature with the thermostat knob (T). Once the oven has reached the temperature, the orange thermostat light goes off and the oven is ready to receive the food to be cooked. At this point, set the desired cooking function. CAUTION: the Quick Start function is not suited to cooking food, it only serves to preheat the oven more quickly. DO NOT USE THE QUICK START FUNCTION FOR MORE THAN 20 MINUTES.

INSTRUCTIONS FOR USE

MP/M3 models with 5-button programmer

Static electric oven

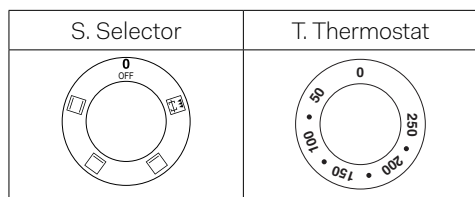

Functions

1		Normal static cooking Is the oven's classic function particularly suited to cooking the following foods: pork chops, sausages, cod, braised beef, game, roast veal, meringues and biscuits, baked fruit, etc.
2		Cooking from underneath This is the most suitable form to finish food cooking, in particular confectionery (biscuits, meringues, leavened cakes, fruit desserts, etc.) and other foods.
3		Cooking from above Especially suitable for browning and to give the final touch of colour to many foods; it is recommended for hamburgers, pork chops, veal steaks, sole, cuttlefish, etc.
4		Closed door grill cooking The suitable function for fast and deep grilling, to brown and roast meats in general, fillet steaks, Florentine steaks, grilled fish and also grilled vegetables. Cooking with the electric grill must be made with the thermostat at 180 °C closed door.

5-Button programmer

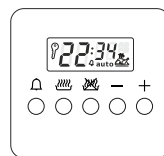

	Timer
	Duration and manual function
auto	Automatic program

Display

	Timer
	Automatic cooking duration
	Setting cooking end time
[-]/[+]	Decrease / Increase the selected parameter

Standby mode

Time to reach stand-by mode: 1 minute.

Power consumption in stand-by with information: 0.8W.

Function setting

Select the desired function by pressing the corresponding button and set the time using the +/- keys.

Appliance operation

When the control is powered on for the first time, the display shows a flashing clock that increments by one unit every minute. Follow the procedure described in the "Clock Setting" section below. By simultaneously pressing the and buttons, the appliance enters the "Manual Mode". The temperature can be set using the thermostat knob (T), and the desired function can be selected using the selector switch (S).

Clock setting

The clock function is activated by simultaneously pressing the cooking duration and end of cooking buttons.

The time can then be set using the +/- keys. Any previously set programs will be automatically cancelled.

Manual mode

This mode is activated by simultaneously pressing the cooking duration and end of cooking buttons. The **auto** symbol will turn off. Any previously set programs will be deleted.

Semi-automatic function with cooking duration



Turn on the oven, select the cooking duration function (button) and set the desired time using the +/- keys. The **auto** symbols will appear on the display. When the current time matches the calculated end time (which can be checked using the end of cooking button), the oven will switch off. An acoustic signal will sound, and the **auto** symbol will flash.

Semi-automatic function with end of cooking time





Turn on the oven, select the end of cooking function (button),

INSTRUCTIONS FOR USE



MP/M3 models with 5-button programmer

and set the desired end time using the +/- keys. The **auto**  symbols will appear on the display. When the current time reaches the programmed end time, the oven will switch off. An acoustic signal will sound, and the **auto**  symbol will flash.

Semi-automatic function with cooking duration and end time

Turn on the oven, select the cooking duration function (**auto**  button), and set the desired time using the +/- keys. The  symbol will appear on the display. Wait a few seconds until the current time is displayed. Then set the end of cooking time by pressing the end of cooking () button and adjusting with the +/- keys. The oven will switch off at the end of the automatic program. The **auto**  symbol will flash, and the acoustic signal will sound.

Timer

Select the timer function () button), and set the desired time using the +/- keys. During countdown, the bell symbol  will remain lit. When the countdown reaches zero, the acoustic signal will sound.

Acoustic signal

The acoustic signal activates at the end of the cooking duration or minute minder functions and remains active for 7 minutes. It can be silenced by pressing the  button. The signal's volume can be adjusted by pressing the "-" key without selecting any function beforehand. Three sound levels are available, and the selected volume depends on how long the "-" button is held.



Starting a program and monitoring

Once a program has been selected, it starts after the time has been set. The remaining time can be viewed at any moment by re-selecting the corresponding function.



Cancelling a program

A program can be cancelled by selecting the manual mode function. At the end of an automatic program, it will be cleared automatically.

Child lock

All buttons are locked and the oven becomes inactive. This prevents children from accidentally operating the appliance. Note: To deactivate the child lock, press and hold the  and  buttons for 3 seconds until the key symbol disappears.



To activate the child lock function, press and hold the  and  buttons for 3 seconds.



The key symbol will appear on the display (child lock active).

Clock mode (12/24-hour format)

You can switch between 24-hour and 12-hour (AM/PM) clock display by pressing and holding the **+** button for 3 seconds.

INSTRUCTIONS FOR USE

E3 models with 5-button programmer

5-Button programmer

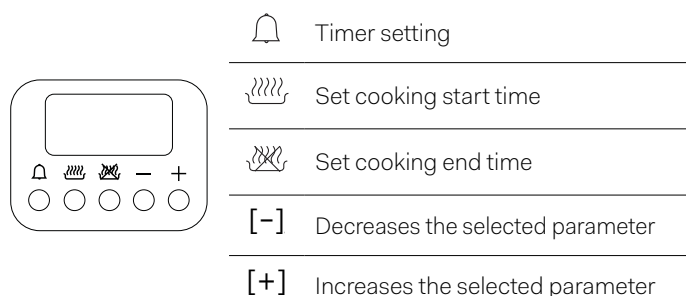

Display

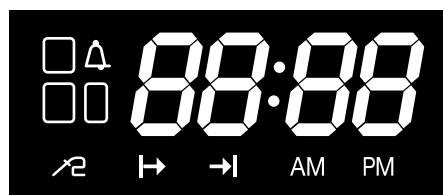

It consists of 4 digits and indicates:

- In stand-by: the current time.
- During manual cooking: the set temperature.
- During time-based automatic cooking: the set temperature.
- During cooking with meat probe: the probe temperature.
- With the timer function active and the oven in stand-by: the current time.

Icons

	Main Oven Icon [1]. If flashing, the display shows the temperature and cooking duration settings for the main oven (only for double oven models).*
	Secondary Oven Icon [2]. If flashing, the display shows the temperature and cooking duration settings for the secondary oven (only for double oven models).*
	If illuminated, it indicates that the minute minder is active. If flashing, it indicates that the minute minder has ended. During minute minder setting, the icon flashes.
	If illuminated, it indicates that the oven is operating in delayed start mode. The icon remains lit throughout the delay period.
	If illuminated, it indicates that the oven is operating in automatic end-of-cooking mode. During the delayed start period, the icon flashes and becomes steadily lit once cooking begins.
AM	If illuminated, it indicates that the clock is in 12-hour AM mode.
PM	If illuminated, it indicates that the clock is in 12-hour PM mode.
(*) When both ovens are in use, press the corresponding thermostat knob to view the temperature and cooking duration settings for the main or secondary oven.	

Standby mode

Timing for reaching low power mode: 1 min.

Power consumption in stand by with information: 0,8

Appliance operation

At first power-up, the display shows a flashing clock that increases by one unit every minute. The oven remains locked, and can be unlocked in one of the following ways: Set the time using the [+] and [-] buttons (see "Clock Setting" procedure). Alternatively, turning on the oven directly accepts the current clock value as-is. Detailed procedures for setting the clock, minute minder, cooking duration, and end of cooking time are provided in the following sections. By pressing one of the setting buttons (bell icon, wavy line icon, wavy line with flame icon), the appliance enters edit mode (indicated by a flashing display), where the [+] and [-] buttons can be used to adjust the value. If no button is pressed for 4 seconds, the value is automatically confirmed, and the display returns to a steady (non-flashing) state. To cancel all settings, press and hold the wavy line icon and wavy line with flame icon buttons simultaneously.

Clock setting

Press and hold the wavy line icon and wavy line with flame icon buttons simultaneously for 5 seconds — the display will begin flashing. Adjust the time using the [+] and [-] buttons. Clock adjustment is only allowed when the oven is in standby mode. To change the time format (12h/24h), during clock setting press the bell icon button for 4 seconds. Use the [+] button to choose between 24-hour format or 12-hour format (AM/PM).

Turning the oven on and off

Turn the function selector [S]. The display will show "On". After 2 seconds, the internal oven light turns on, and the display shows the default temperature for the selected cooking function. To turn the oven off during cooking, return the selector to position [0]. The display will show "OFF".

Timer

This function operates independently of the oven's heating elements and is always available. Press the bell icon button. The bell symbol lights up, and the display shows "0' 00". Set the desired time (up to 180 minutes) using the [+] and [-] buttons. If no changes are made within 4 seconds, the time is saved and the bell symbol remains steadily lit. To return to clock mode after setting the minute minder, press the bell icon button again — the new value will be confirmed. When the countdown reaches zero, an acoustic signal is emitted, and the bell symbol flashes. To stop the signal and flashing, press any button.



Manual operation with unlimited time

Turn on the oven. Select a desired cooking function. Use the thermostat knob [T] to set the desired temperature. After 4 seconds without further adjustment, the oven starts cooking with no time limit, and the selected temperature remains displayed.



INSTRUCTIONS FOR USE

E3 models with 5-button programmer

Semi-automatic end of cooking operation

Turn on the oven. Press the  button, and the display shows "End." Set the end of cooking time using the [+] and [-] buttons (the maximum cooking time is 10 hours). Press the  button after adjusting the time to return to clock mode, accepting the newly set value. After 4 seconds of inactivity, the oven starts cooking for the set time. Once the programmed time is reached, the oven enters end of cooking mode.

Automatic operation

Turn on the oven. Press the  button, and set the start time using the [+] and [-] buttons. Press the  button, and the display shows "End." Set the end of cooking time using the [+] and [-] buttons. If no cooking time is selected, the oven remains in manual operation with unlimited time. After 4 seconds of inactivity, the oven starts cooking until the specified time is reached. You can always select a cooking function from the available options, and the temperature can be adjusted. Once the programmed time is reached, the oven enters end of cooking mode. This function is not available with the grill and fan grill cooking programs.

End of cooking mode

At the end of time-based cooking, the oven switches off all heating elements, a triple intermittent acoustic signal of medium intensity is activated, and the display shows the time. The cavity symbol flashes. To unlock the oven, simply press any button on the programmer: the acoustic signal stops, and the oven is ready to receive new commands.

Cooking temperature selection

The maximum temperature varies depending on the type of function. Upon turning on the oven, a default temperature is proposed for each function: the cooking temperature can be modified. By slightly rotating the [T] knob clockwise, the temperature increases (in increments of 5°C), and counterclockwise, it decreases (in increments of 5°C). During temperature adjustment (flashing display), the unit of measurement can be changed from °C to °F and vice versa by holding the [T] knob for 8 seconds.

Oven light control

After the oven is turned on, the light remains on for 1 minute, and at the end of preheating, it turns on again for 1 minute. During the waiting phase of a delayed start, the oven light remains off. The oven light can always be turned on by pressing the [T] knob, and it will turn off automatically after 1 minute. During cooking, the light can be left on continuously by pressing the [T] knob for 3 seconds.

Child safety lock





The oven is equipped with a safety device that prevents unintended or accidental starting. To activate the safety lock with the oven off, press and hold the [T] knob for 5 seconds. A short acoustic signal will sound, and the display will show the symbol "n—0". In this state, it is impossible to start the oven. To deactivate the previously set safety lock, press and hold the [T] knob for 5 seconds.

Cooking inspection

If it is necessary to inspect the food during cooking, the oven door can be opened. In this case, the lights turn on, and the cooking process is paused. When the door is closed again, the previously set function is reactivated.

Dry/Wet cooking *

The oven is equipped with an automatic device that allows cooking condensation vapors to be expelled from the oven during certain functions, resulting in dry cooking. If the cooking process requires moisture to remain inside the oven, moisture cooking, the automatic device can be disabled by performing the following operation: after selecting the desired cooking function, when the display shows [ON], press and hold the "-" button on the programmer for about 2 seconds until the display shows [HUM]. This choice allows you to switch between dry cooking and moisture cooking at your preference. The functions affected are:

	Normal Static Cooking *
	Bottom Heat Cooking *
	Top Heat Cooking *
	Intensive Cooking *
	Multiple Fan Cooking *

Cooking with Probe (available only on certain models)

Note: Cooking with the probe cannot be used in the "DEFROST," "QUICK START," "PIZZA," and "ECO" functions.

With the oven in stand-by, insert the meat probe into the appropriate connection socket, which is usually located on the left wall of the oven. The display will show "MEAT" for 2 seconds, and the probe symbol will start flashing. Then, the default probe temperature value (75°C) will appear on the display. Turn and then press the control knob to select the desired end cooking temperature between the two limits of 40°C and 100°C (internal temperature of the food). After 4 seconds from the last setting, the chosen temperature will be stored, and the probe symbol will remain lit. Turn on the oven, select the cooking function, and set the desired temperature using the appropriate knobs. The temperature read by the probe will then appear on the display. When the programmed probe temperature is reached, the oven will turn off, an audible signal will sound, "End" will flash on the display, and the oven will switch to "cooking finished" mode.

During cooking, it is always possible to modify the probe temperature by pressing the knob 3 times and then turning the control knob.

Note: If the probe is inserted into the connection socket during cooking, the oven will turn off, and "Off" will appear on the display.

If the probe is removed from the socket during cooking, the oven will turn off, and "Off" will appear on the display.

INSTRUCTIONS FOR USE

E3 models with 5-button programmer

Multifunction electric oven

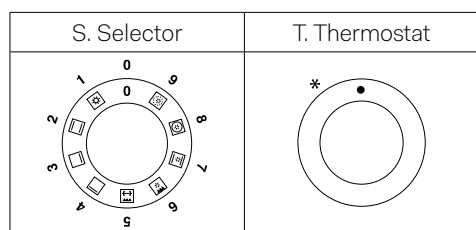

Functions

1		Pizza cooking This function is particularly suitable for cooking pizza, focaccia and bread. The main source of heat is from the bottom heating element that works in combination with the oven's other resistances.
2		Normal static cooking * (dry/Wet) Is the oven's classic function particularly suited to cooking the following foods: pork chops, sausages, cod, braised beef, game, roast veal, meringues and biscuits, baked fruit, etc.
3		Cooking from underneath * (dry/Wet) This is the most suitable form to finish food cooking, in particular confectionery (biscuits, meringues, leavened cakes, fruit desserts, etc.) and other foods.
4		Cooking from above * (dry/Wet) Especially suitable for browning and to give the final touch of colour to many foods; it is recommended for hamburgers, pork chops, veal steaks, sole, cuttlefish, etc.
5		Closed door grill cooking The suitable function for fast and deep grilling, to brown and roast meats in general, fillet steaks, Florentine steaks, grilled fish and also grilled vegetables. Cooking with the electric grill must be made with the thermostat at 180 °C closed door.
6		Fan grill cooking Particularly fast and deep with significant energy savings, this function is suitable for many foods such as pork chops, sausages, pork or mixed spits, game, gnocchi alla romana, etc. Cooking with the electric grill must be made with the thermostat at 180 °C closed door.
7		Intensive cooking * (dry/Wet) Is the quick and intense cooking function for various dishes; best for: baked fish, braised vegetables, spits, duck, chicken, etc.
8		Multiple fan cooking * (dry/Wet) Is the function that allows simultaneous cooking of different dishes without the smells blending; you can cook lasagne, pizza, croissants and brioches, tarts, cakes, etc.
8a		Eco cooking It is the function that allows you to cook with a considerable saving on electricity consumption. To make the most of this feature it is useful, before inserting the ECO function, to introduce the dish inside the oven, positioning it in the center of the cavity. With the Eco function, cooking times adapt to slow cooking such as: braised meats, white meats, baked pasta, delicate pastries. This cooking cycle is not recommended for frozen foods. To select Eco cooking turn the selector knob "S" to position 8 and then, when the word "ON" appears on the display, hold down the "+" key of the programmer for about 2 seconds until the display shows the message "ECHO". With Eco cooking the programmable temperature ranges from a minimum of 30 °C up to a maximum of 300 °C. Note: Eco cooking cannot be selected with the meat probe inserted.

9		Quick Start This function is used to speed up the preheating of your oven. We suggest you use this function when setting a cooking temperature between 200 and 250° C. Using the QuickStart function for temperatures below 200° C does not offer particular advantages. To use the Quick Start function, turn the selector knob (S) until it is positioned on the symbol (9), then set the desired temperature with the thermostat knob (T). Once the oven has reached the temperature, the orange thermostat light goes off and the oven is ready to receive the food to be cooked. At this point, set the desired cooking function. CAUTION: the Quick Start function is not suited to cooking food, it only serves to preheat the oven more quickly. DO NOT USE THE QUICK START FUNCTION FOR MORE THAN 20 MINUTES.
---	--	--

Static oven

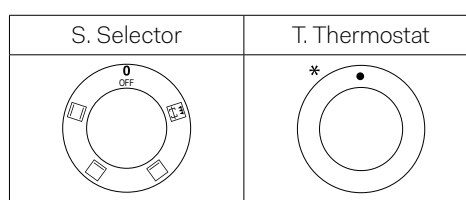

Functions

1		Normal static cooking Is the oven's classic function particularly suited to cooking the following foods: pork chops, sausages, cod, braised beef, game, roast veal, meringues and biscuits, baked fruit, etc.
2		Cooking from underneath This is the most suitable form to finish food cooking, in particular confectionery (biscuits, meringues, leavened cakes, fruit desserts, etc.) and other foods.
3		Cooking from above Especially suitable for browning and to give the final touch of colour to many foods; it is recommended for hamburgers, pork chops, veal steaks, sole, cuttlefish, etc.
4		Closed door grill cooking The suitable function for fast and deep grilling, to brown and roast meats in general, fillet steaks, Florentine steaks, grilled fish and also grilled vegetables. Cooking with the electric grill must be made with the thermostat at 180 °C closed door.
5		Eco cooking It is the function that allows you to cook with a considerable saving on electricity consumption. To make the most of it this feature is useful, before inserting the ECO function, introduce the dish inside the oven placing it in the center of the cavity. With the Eco function, cooking times adapt to slow cooking such as: braised meat, white meat, baked pasta, delicate pastry. This cooking cycle is not recommended for frozen foods. To select Eco cooking turn the selector knob "S" to position 1 and then, when the display shows "ON", hold down the "+" key of the programmer for about 2 seconds until the appearance on the display of the word "ECO". With Eco cooking the programmable temperature goes from a minimum of 30 °C up to a maximum of 250 °C.

INSTRUCTIONS FOR USE

Cooking charts

Convection oven (indicative values)

DISH	TEMP (°C)		TIME (MIN)
MEATS			
Roast beef	170/180	2/3	40/50
Roast ox	170/190	2/3	40/60
Roast veal	160/180	2/3	65/90
Roast lamb	140/160	2	100/130
Rare roast beef	180/190	2/3	40/45
Roast hare	170/180	2/3	80/100
Roast rabbit	160/170	2	80/100
Roast turkey	160/170	2	160/240
Roast goose	160/180	2/3	120/160
Roast duck	170/180	2/3	100/160
Roast chicken	180	2/3	90/120
FISH	160/180	2/3	15/25
PATISSERIE			
Fruit cake	180/200	2	40/50
Margherita cake	180/190	2	40/45
Brioches	170/180	2	40/60
Sponge cake	190/200	2	25/35
Donuts	160/180	2	35/45
Sweet puff pastry	180/200	2	20/30
Grape flatbread	190/200	2	30/40
Strudel	160	2	25/35
Savoirdi biscuits	150/180	2	50/60
Apple fritters	180/200	2	18/25
Savoirdi pudding	170/180	2	30/40
BAKERY			
Bread	180/200	3	45
Pizza	250	3	10/20
Toast	185/195	2	7

Static oven (indicative values)

DISH	TEMP (°C)		TIME (MIN)
MEATS			
Roast beef	225	2/3	60/80
Roast ox	250	2/3	50/60
Roast veal	225	2/3	60/80
Roast lamb	225	2	40/50
Rare roast beef	230	2/3	50/60
Roast hare	250	2/3	40/50
Roast rabbit	250	2	40/50
Roast turkey	250	2	50/60
Roast goose	225	2/3	60/70
Roast duck	250	2/3	45/60
Roast chicken	250	2/3	40/45
FISH	200/225	1/2	15/25
PATISSERIE			
Fruit cake	225	2	35/40
Margherita cake	175/200	2	50/60
Brioches	175/200	2	25/30
Sponge cake	220/250	2	20/30
Donuts	180/200	2	30/40
Sweet puff pastry	200/220	2	15/20
Grape flatbread	250	2	25/35
Strudel	180	2	20/30
Savoirdi biscuits	180/200	2	40/50
Apple fritters	200/220	2	15/20
Savoirdi pudding	200/220	2	20/30
BAKERY			
Bread	220	3	30
Pizza	250	3	10/20
Toast	250	3	5

IMPORTANT: Introduce the food when the oven is preheated.

Grill cooking

For appliances with an electric grill, cooking is done with the door closed at 180°C. The food to be grilled should be placed on the corresponding grill, preferably on the fourth rack.

Rack positions

There are 5 rack positions – position 1 is the lowest, and position 5 is the highest, close to the grill. If cooking a single dish, use rack position 3. If cooking multiple trays, depending on the height of the tray or the food, it is recommended to cook on rack positions 2 and 4. Use rack positions 4 and 5 for grilling and the grill pan on the bottom rack position 1 to catch any drips. The bottom rack position 1 can be used to slow down cooking or to reduce the temperature.

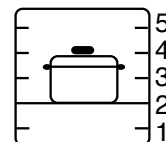

INSTRUCTIONS FOR USE

Cooking charts

IMPORTANT: Always insert the thermometer up to the handle so that the tip is in the center of the roast, not near the bone or in the fatty part.

DISH	TEMP (°C)
Beef	
Roast beef - Rare beef tenderloin	40-45
Roast beef - Well-done beef tenderloin	50-55
Roastbeef - Filetto di manzo ben cotto	60-65
Roast beef	80-85
Pork	
Pork loin	65-70
Roast pork	80-85
Pork shoulder, pork shank	80-85
Pork chop	75-80
Boneless cutlet	70
Cured pork chop (Kassler)	65-70
Meatloaf	70-75
Veal	
Roast veal	70-75
Roast veal with kidneys	75-80
Veal foot	80-85
Game meat	
Game meat	75-80
Loin	60-70
Rare tenderloin	40-45
Medium tenderloin	50-55
Well-done tenderloin	60-65
Lamb	80-85
Roast	70-75
Poultry	85-90
Fish	85-90

INSTRUCTIONS FOR USE

Accessories

Use of the rotisserie spit (available only in some models)

Slide the meat onto the spit rod, securing it with the appropriate forks. Place the rod onto the rotisserie supports previously inserted into the drip tray, and insert it into the rotisserie motor shaft. Turn on the static grill function with the door closed. To remove the spit along with the drip tray, pull it out just enough to allow for complete extraction.

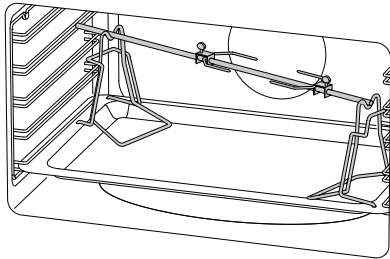

Telescopic guides (available only in some models)

This solution is designed to enhance ergonomics, practicality, and safety when handling trays and pans in the oven. The kit consists of fully extendable side rails that slide on ball bearings to facilitate the removal and placement of trays. The rails are anti-tip for added safety. They can be removed for cleaning or repositioned, as shown in the photos below.

1. Pull down the part highlighted in red to remove it from the oven wall.
2. Turn them over and place them on a flat surface with the sliding guide side facing down..
3. To release the clip, loosen it with a flathead screwdriver..
4. Repeat the steps in reverse to reposition the guide..

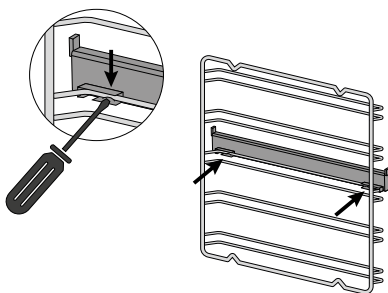
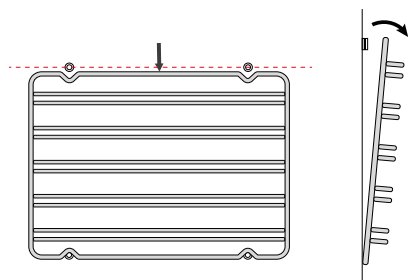

Warm drawer (available only in some models)

WARNING: Do not leave plastic/synthetic or easily inflammable objects inside the drawer. When the appliance is turned on, these objects or materials could melt and catch fire (fire hazard).

Do not sit or step on the drawer: this will help prevent injury or damage to the appliance.

Setting

After selecting the heated drawer icon on the display, the corresponding screen for setting the operating parameters will appear. Here, you can select the temperature to heat the dishes between 30°C and 80°C. Additionally, you can select the heating duration.

First use

Before using the appliance, clean the drawer following the instructions in the "Cleaning and Maintenance" section. Then, turn on the heated drawer for at least 2 hours, selecting the maximum temperature. The resulting unpleasant odor is inevitable. Both the odor and any smoke that may form will dissipate shortly.

Optimal temperature for dish groups

40°C - For cups and glasses

With this setting, the contents of cups and glasses do not cool quickly, and they can still be removed from the drawer without burning yourself.

60°C - Ideal for plates and serving dishes.

Food served on heated plates will stay warm longer. In any case, the plates can still be touched safely.

Heating times

Several factors influence the heating times:

- Material and thickness of the dishes
- Position of the dishes
- Ambient temperature

Therefore, precise heating times cannot be provided. However, as a reference, here are some useful times:

Quantity: Dishes for 6 people / Time (minutes) 30-35

With frequent use of the drawer, it will be easier to identify the appropriate times and temperatures for heating dishes.

WARNING! The surfaces of the drawer can become hot during operation..

CLEANING AND MAINTENANCE

Removing the door

To facilitate intensive cleaning of the oven, it is practical to remove the door by following these instructions:

1. Open the door
2. Move the latch C to the hinge section D following the steps:
3. Unscrew the screw (only for some models)
4. Remove the door

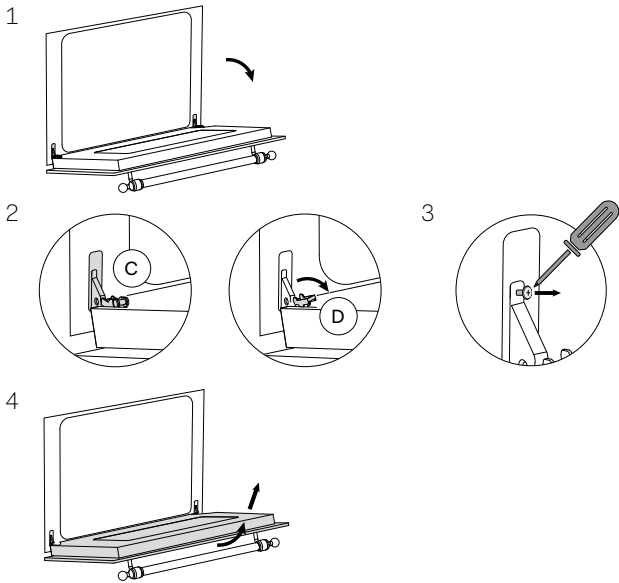

Lamp Replacement

If the oven light is not working, disconnect the appliance from the power supply, remove the protective glass of the lamp, and replace the bulb. It is important to ensure that the replacement bulb is suitable for high-temperature use and has the necessary specifications for such an application.

1. Loosen with a flathead screwdriver
2. Remove the lamp cover glass
3. Remove the lamp:
4. Replace and close it:

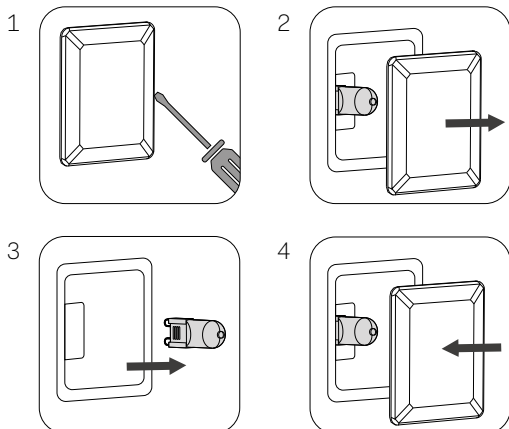

Disassembly and cleaning of the glass

The oven door is made up of three glass panels. The cleaning of the glass parts is done using non-abrasive kitchen paper and a common detergent. Do not use rough abrasive materials or sharp metal scrapers to clean the oven glass doors as they may scratch the surface and cause the glass to break. The inner glass panels are removable (the middle glass should be correctly repositioned with the THERMOSTOP writing readable, as shown in figure 3) to make cleaning easier. To do this, it is necessary to disassemble the oven door.



ATTENTION: Any operation should always be carried out with the door removed from the oven and placed on a suitable surface to avoid damaging the front of the door. The middle glass must be correctly inserted with the THERMOSTOP label readable, as shown in the following images:

1. Unscrew the 2 screws on the right/left side of the top strip

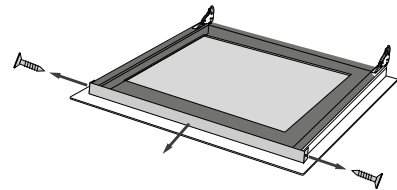

2. Lift the top glass and slide it out

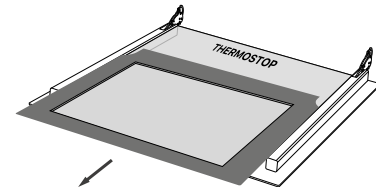

3. Slide out the middle glass

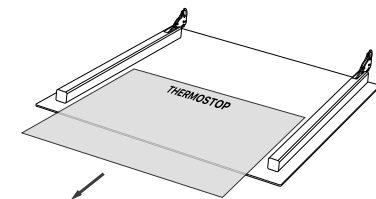

CLEANING AND MAINTENANCE

Opening and closing the door (Panoramagic)

WARNING! To avoid physical injury, it is recommended to grasp the handle when opening and closing the door, as shown in the following images.

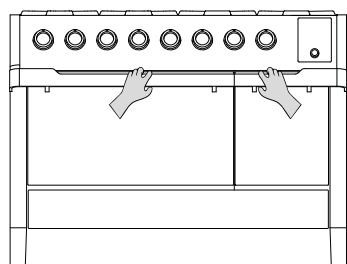
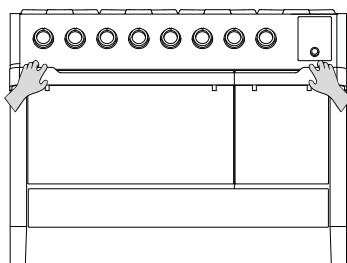
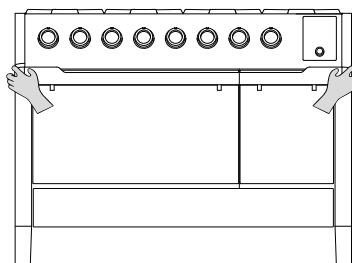

Total black burners

WARNING! The burners are coated with a nanotechnology treatment.

To preserve the quality of the coating, specific cleaning and washing methods are recommended.

- Allow the product to cool to room temperature before cleaning. It is advised not to immerse it in cold water when still hot.
- Clean with warm water and a minimal amount of neutral detergent. Wipe with a cloth, preferably made of natural cellulose, or a non-abrasive sponge.
- Do not use powders, steel wool, abrasive cloths, or sponges.
- Do not allow food to burn on the burner. In such cases, stains or discoloration may appear on the surface. These marks do not affect the functionality of the product, and in some cases, they can be removed using the following procedure: immerse the product in warm water with detergent, gently scrub with a cloth, preferably made of natural cellulose, and avoid using abrasive cloths or sponges. For more stubborn stains, it is advisable to heat white vinegar and scrub as described above.
- Avoid leaving burners in contact with food for long periods, especially if acidic, such as tomato sauce.
- Avoid contact with metal objects. If necessary, use wooden or plastic items.
- Avoid dishwasher washing, as part of the product is not coated and would be irreparably damaged.
- In case of malfunction, ensure that the holes of the outer crown are always perfectly clean.
- For the correct operation of the DUAL burner, keep the ignition channel clean as highlighted in the image below.

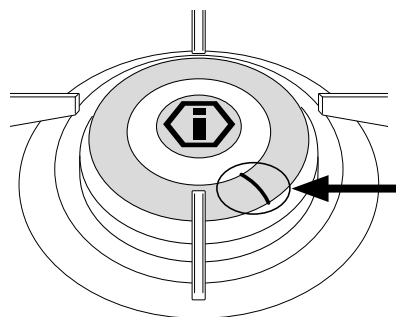

CLEANING AND MAINTENANCE

Cleaning tips for the oven and front panel



Before performing any cleaning operation, disconnect the appliance from the power supply and close the main gas valve to the appliance. The worktop should only be cleaned once it has cooled down.

OVEN		
COMPONENT	CLEANING METHOD	WARNINGS
Oven interior	It is recommended to clean the oven after each use. Dirt is easier to clean if it is prevented from burning at high temperatures repeatedly. Remove all removable parts and wash them separately with warm water and non-abrasive detergent. Clean the cooking cavity with a soft cloth soaked in a solution of warm water and ammonia, then rinse and dry.	Do not use steam cleaners for cleaning the oven interior. Do not use abrasive/corrosive detergents or sharp metal tools to clean the oven's glass door, as they may damage the surface and cause it to break.
Tray	Soak in a solution of warm water and mild soap. Dry after washing.	Remove food residues immediately after use.
Racks	Clean with hot water and non-abrasive detergents or with a suitable degreaser.	In case of baked-on and hardened dirt, it is recommended to soak the racks for a few hours before cleaning.

FRONT PANEL		
COMPONENT	CLEANING METHOD	WARNINGS
Stainless steel/ glass surface	Clean the details with lukewarm water and non-corrosive liquid detergent, then dry them with a soft cloth or microfiber cloth.	Shine is maintained through periodic cleaning with specific products typically available on the market. Never use abrasive powders.
Painted surfaces	To maintain the characteristics of the painted parts, it is necessary to clean them frequently with soapy water.	Avoid leaving acidic or alkaline substances (vinegar, lemon juice, salt, tomato juice, etc.) on the painted parts, and do not wash the painted surfaces while they are still hot.

HOB		
COMPONENT	CLEANING METHOD	WARNINGS
Stainless steel surface	Clean the components with lukewarm water and a non-corrosive liquid detergent, then dry them with a soft or microfiber cloth.	Shine is maintained through regular cleaning with appropriate commercial products. Never use abrasive powders.
Enamelled surface	To maintain the characteristics of the enamelled parts, they should be cleaned frequently with soapy water.	Avoid leaving acidic or alkaline substances (vinegar, lemon juice, salt, tomato juice, etc.) on the enamelled parts and do not clean when the enamelled parts are still hot.
Hob grids	Remove the grids and clean them with lukewarm water and a non-abrasive detergent. Carefully remove any encrustations. Dry them before placing them back on the hob.	Acidic substances such as lemon juice or other acidic detergents can irreparably damage the enamel on the grids. Dry the grids carefully with a cloth immediately after washing. Dishwasher cleaning is not recommended.
Glow plugs and thermocouples	Clean them with a damp cloth. Any dry residue should be removed with a wooden stick or a pin.	Ignition candles and thermocouples should always be checked and cleaned periodically.
Crowns, flame spreader, and caps	The flame spreaders and caps are removable for easier cleaning. Wash them in hot water with a non-abrasive detergent.	Carefully remove any encrustations and wait for them to be completely dry. In case of malfunction, ensure that the holes in the outer crown are always perfectly clean.
Induction hob	Remove light stains with a damp cloth and then dry with a dry cloth.	Do not clean with corrosive or abrasive products. Do not use any items that could damage the ceramic glass hob. Ensure that the bottom of the pot is dry and clean, and that the glass surface is free of powders. Moving the pot could scratch the glass. Immediately remove any sugar, jelly, or jam residues to prevent damage to the glass.

TROUBLESHOOTING

Generic problems

Attention

- During the warranty period, repairs can only be carried out by an authorized Service Center or by using the appropriate switch.
- Before performing any repairs, disconnect the appliance from the electrical network, meaning unplug the power cord or use the appropriate switch.
- Unauthorized interventions and repairs can cause electric shock or short circuits, so do not attempt them. Leave such work to authorized technicians.
- In the case of minor issues, you may try to resolve the problem by following the instructions provided.
- Service assistance during the warranty period is not free if the appliance malfunction is due to incorrect usage.
- Faults or complaints caused by improper use or installation will not be repaired under warranty. Warranty costs will be borne by the user.

Child lock

Symbol representing the child lock

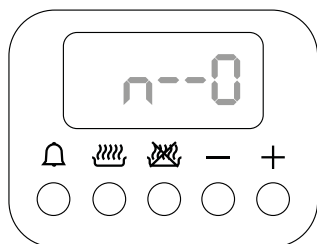

ATTENTION: If this symbol appears on your oven, do not worry. It may have been accidentally activated. The oven is equipped with a safety device that prevents accidental or unwanted operation by children.

How to deactivate

To deactivate the previously activated safety, press and hold the temperature control thermostat knob for 5 seconds. The display will show "n—o" followed by "OFF."

How to activate

How to activate: To activate the safety feature, press and hold the temperature control thermostat knob (T) for 5 seconds with the oven turned off.

A short beep will sound, and the display will show "n—o" followed by "ON."

The oven will then be locked and cannot be started.

Small issues solvable without the help of a specialized technician

PROBLEM	POSSIBLE CAUSE	RESOLUTION
The flame is not uniform.	Improper gas adjustment.	The gas adjustment must be checked by an expert.
The flame suddenly changes.	Burner parts are not positioned correctly.	Correctly position the burner parts.
To ignite the burners, the ignition knob must be held down for a longer time.	Burner parts are not positioned correctly.	Correctly position the burner parts.
After ignition, the flame goes out.	The knob was not pressed long enough or was pressed too gently.	Hold the knob for a longer period before releasing it, press firmly.
The grate in the burner area has changed color.	A natural phenomenon due to high temperature.	Clean the grill with metal cleaner.
Electrical operation, in general, appears disturbed.	Igniter or terminal block damaged.	Check the igniter and/or terminal block and replace it if damaged.
The electric ignition no longer works.	Food or detergent residue between the ignition electrode and the burner.	Carefully clean between the ignition electrode and the burner.
The burner caps are dirty.	Normal dirt.	Clean the burner caps with metal cleaner.
The display does not respond to commands.	Touchscreen display locked.	Open and close the oven door.

ANOMALIES	CAUSES
The appliance and cooking zone do not turn on.	<ul style="list-style-type: none"> - The hob has not been correctly connected to the power supply. - The protection fuse is blown. - The KEY-LOCK function is activated.
The symbol "U" appears on the display.	<ul style="list-style-type: none"> - The pot has not been placed on the cooking zone. - The pot is not compatible with induction. - The diameter of the pot's base is too small.
The symbol "E" appears on the display.	<ul style="list-style-type: none"> - The electronic system is defective. - Disconnect the hob from the electrical network. - Contact the authorized service center.
The cooking zones do not function.	<ul style="list-style-type: none"> - The safety system is activated. - The pot is empty, and the bottom has overheated.
If the ventilation remains active when the hob is off.	<ul style="list-style-type: none"> - This is not a fault. The fan continues to operate to protect the electronics. - The automatic ventilation will stop automatically.

INSTALLATION

Instructions for installation

⚠ The installer is required to provide the user with the following information:

- Check the integrity of the appliance and ensure all documentation regarding the product is present.
- Verify that the appliance has all the included accessories.
- Verify the proper use of the appliance (oven use, thermostat use, ignition and re-ignition of burners).
- Suggest completing the warranty registration form.
- Recommend applying a periodic maintenance service at least every two years.

⚠ Gas leak

In case of a gas leak, close the gas supply and disconnect the appliance from the electrical network. Contact the authorized service center. All operations and maintenance must be carried out exclusively by authorized and qualified personnel.

⚠ Attention

The appliance weighs more than 60 kg, so handling must be done with appropriate equipment.

Measures to be followed

To avoid bending the support feet, never drag the appliance. The correct procedure for positioning the appliance involves lifting it using proper equipment. **DO NOT LIFT BY HANDLE**

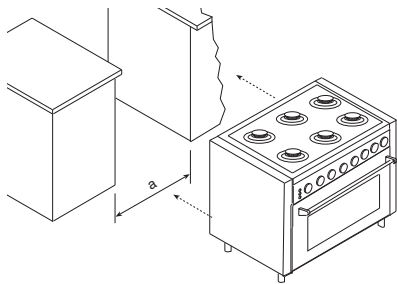

a (mm)	models	a (mm)	models
600	P06 - L06	1000	PD10 - M10 - LD10
700	P07 - M07	1200	P12 - L12
800	P08	1216	M12 - PM12
900	P09 - L09 - K09 - PD09 - LD09	1500	P15
911	M09 - PM09	1511	M15

Directives / regulations

This appliance is in compliance with the applicable standards. Installation must only be carried out by qualified persons in compliance with the regulations and standards in force.

Room ventilation

This is a type "A" appliance which does not need to be joined to an exhaust system for combustion waste but must be installed under a hood or other smoke extraction system in compliance with the standards in force. The knowledge and consultation of the standards are a key factor for a qualified technician. In-

dicatively the amount of air necessary for burner combustion is 2 m³/h for each KW of nominal power installed (see plate). Should the appliance be subjected to intensive and prolonged use, supplementary ventilation may be necessary; in such cases open a window or increase the extractor fan's power.

Positioning of the appliance between furniture

The cooker is protected against excessive overheating, so it may be installed next to furniture with a height no higher than that of the worktop. The wall in contact with the back of the cooker must be made of fire-resistant material. To install the cooker correctly, take the following precautions.

*A. The clearance between the highest point of the highest burner of the gas cooking appliance and a range hood should be no less than 700mm for all models. For an overhead exhaust fan the minimum clearance is 750 mm.

This should be measured as 700mm from the highest point of the highest burner to the overhead units.

**B. Where the distance from the periphery of the nearest burner to any vertical combustible surface, or vertical combustible surface covered with toughened glass or sheet metal, is less than 200 mm, the surface shall be protected to a height C of not less than 150 mm above the hob for the full dimension (width or depth) of the cooking surface area. Where the gas cooking appliance is fitted with a 'splash back', protection of the rear wall is not required.

C. If the cooker is installed under a wall unit, the minimum distance between the highest point of the highest burner and the overhead units must be 700 mm.

D. Zero clearance to bench surfaces at the same height as the top edge of the cooker is permitted.

Majestic / Professional Plus / Nostalgie / Pro Line/ Panoramagic

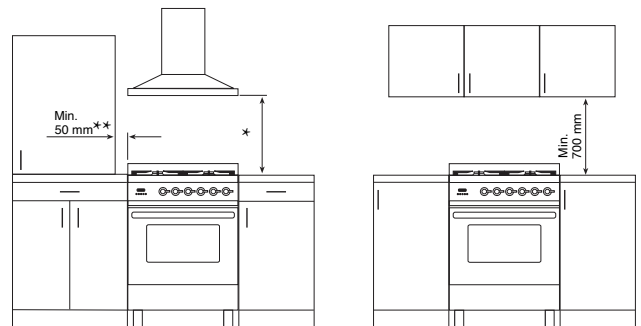

INSTALLATION

Instructions for installation

How to install the fixing bracket



WARNING: possibility of overturning



WARNING: to prevent the device from overturning, this stabilizing means must be installed. Refer to the installation instructions.

.Modelli: 60, 70, 80 (30'), 90, 100, 120 cm.

1. Unbox the kitchen and install the feet, adjusting to the desired height.
2. Measure the height between the floor and the top edge of the rear crossbar and add 15 mm.
3. Mark the total measurement on the back wall of the appliance, approximately at the center of the width of the kitchen. Drill a hole with an appropriate drill bit of 6 mm diameter and secure the bracket in place.
4. Ensure that the kitchen can rest against the back wall and, when in place, it does not allow tipping.

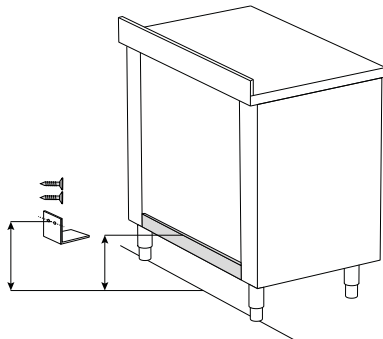

! ATTENZIONE! Il sistema anti ribaltamento è garantito solo se la cucina è installata con la schiena appoggiata alla parete posteriore.

Foot mounting (Panoramagic)

1. Fixing the bracket to the foot:
 - Place the bracket on top of the foot base and ensure that the holes align (a).
 - Secure the 2 screws using an Allen key (b).

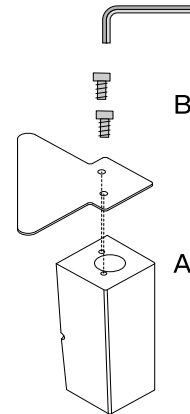

2. Flip the kitchen and place it on its rear side, then:
 - Position the foot and ensure that the screws align with the holes on the kitchen (a)
 - Secure the screws using a screwdriver (4 screws with 4 washers) (b).

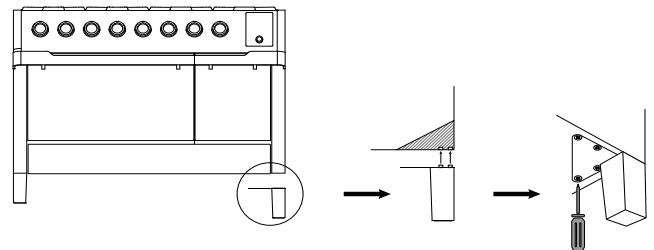

3. Adjusting the height of the feet:
 - Insert the Allen key into the hole of the foot to engage the adjustment screw (a).
 - By turning the adjustment screw, the foot height can be adjusted to eliminate any irregularities in the floor.

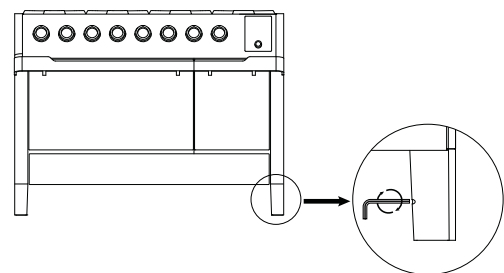

INSTALLATION

Electrical connection

Backguard installation

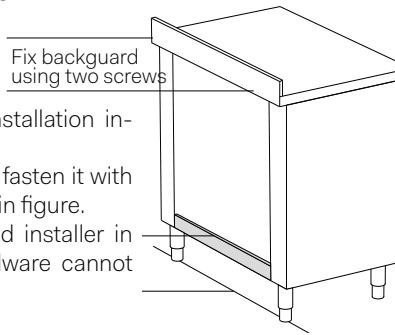

Please follow the following installation instructions in sequence:

- Place the backguard and fasten it with the two screws as shown in figure.
- Please refer to a qualified installer in case the enclosed hardware cannot be utilized.

Range cookers

⚠ ATTENTION! The instructions below are intended for the skilled technician who will install the cooker, regulate it and perform technical maintenance and who will ensure that these operations are carried out in the most correct way possible, in compliance with the regulations in force.

Important: the cooker must be disconnected from the electric socket before performing all regulating or maintenance operations.

Rules for installation

Installation must be carried out in a workmanlike manner, fully complying with the legislation in force regarding electrical installations. Otherwise, the manufacturer disclaims any responsibility. You will find your appliance's wiring diagram in this booklet.

The appliances are prepared for connection to the voltage shown on the data plate.

Before connecting the appliance to the mains check that:

- the electromagnetic switch or the socket are able to support the appliance's load (see dataplate);
- the power supply system must have an efficient grounding system.

The appliance is supplied with a cable but without a plug: the connection must be made taking into account that the green-yellow cable is the ground conductor \perp and it must never be interrupted.

The socket must be visible and easily reachable so that the appliance can easily be disconnected. For direct connection to the mains, it is necessary that:

- the relief valve and domestic system can support the equipment's load (see data plate)
- the power supply system must have an efficient grounding system
- a device must be provided to ensure disconnection from the network, with a contact opening distance that allows full disconnection under the conditions of overvoltage category III, in accordance with the installation rules.
- the socket or omnipolar switch, with a minimum 3 mm contact opening, must be easily reachable once the appliance has been installed.
- means for disconnection must be incorporated in the fixed wiring in accordance with the wiring rules

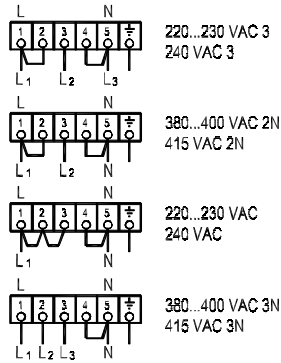

⚠ ATTENTION

The range cooker can be supplied with single-phase, two-phase or three-phase voltage. For correct connection to the mains, follow the diagram below which shows the terminal box, in particular the connection terminals (1-2-3-4-5) and the various power supply lines (L1-L2-L3-N).

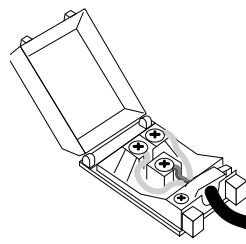

⚠ ATTENTION

The yellow-green ground wire must never be interrupted even by the switch. The power cable should be positioned so that it does not come into contact with surfaces that have a temperature of 50 °C higher than the environment. In case replacement of the power cable is necessary, contact the support service.

If this cooking range is to be connected to a new or upgraded electrical installation, then it must be connected to the supply by a supply cord fitted with:

- an appropriately rated plug that is compatible with the socket-outlet fitted to the final sub-circuit in the fixed wiring that supplies this cooking range; or
 - an appropriately rated installation male connector that is compatible with the installation female connector fitted to the final sub-circuit in the fixed wiring that supplies this cooking range.
- Disconnection incorporated in the fixed wiring shall be in accordance with AS/NZS 3000.

⚠ ATTENTION

The appliance is supplied without outlet: you need a normal one proper for the electric load. The power supply cable should not reach a 50°C temperature above the one of the surrounding.

In range cookers with induction hobs, the 220...230...240 VAC3 connection must not be made.

(* calculated by applying the coincidence factor EN60335-2-6
On kitchens with induction hobs, the 220... 230... 240... VAC3 connection must not be made.

INSTALLATION

Electrical connection

Cooking units with induction hob

WARNING! The appliance is supplied without a cable and plug; therefore, a standardized cable and plug must be installed, capable of handling the load (see table). The power supply cable must be positioned in such a way that at no point it reaches a temperature higher than 50°C above the ambient temperature.

For cookers with an induction hob, the 220/230/240 VAC3 connection should not be made

Power supply cable specifications (with induction top)

Mod.	Power supply	Connections	Cable cross-section	Cable type
P..I06 LBI095	220-240V a.c. 1P+N 50/60 Hz	1 fase + N	3 x 10	H05RR
	380-415V a.c. 2P+N 50/60Hz	2 fase + N	4 x 4	H05RR
	380-415V a.c. 3P+N 50/60Hz	3 fase + N	5 x 1,5	H05RR
P..I09.. M..I09..	220-240V a.c. 1P+N 50/60 Hz	1 fase + N	3 x 10	H07RN
	380-415V a.c. 2P+N 50/60Hz	2 fase + N	4 x 4	H05RR
	380-415V a.c. 3P+N 50/60Hz	3 fase + N	5 x 4	H05RR
PDI09..	220-240V a.c. 1P+N 50/60 Hz	1 fase + N	3 x 10	H07RN
	380-400V a.c. 2P+N 50/60 Hz	2 fase + N	4 x 6	H05RR
	415V a.c. 2P+N 50/60 Hz	2 fase + N	4 x 10	H05RR
	380-400V a.c. 3P+N 50/60 Hz	3 fase + N	5 x 6	H05RR
	415V a.c. 3P+N 50/60 Hz	3 fase + N	5 x 10	H05RR
LDBI09..	220-240V a.c. 1P+N 50/60 Hz	1 fase + N	3 x 6	H05RR
	380-415V a.c. 2P+N 50/60 Hz	2 fase + N	4 x 4	H05RR
	380-415V a.c. 3P+N 50/60 Hz	3 fase + N	5 x 2,5	H05RR
MDI10.. E3	220-240V a.c. 1P+N 50/60 Hz	1 fase + N	3 x 10	H07RN
	380-400V a.c. 2P+N 50/60 Hz	2 fase + N	4 x 6	H05RR
	415V a.c. 2P+N 50/60 Hz	2 fase + N	4 x 10	H05RR
	380-400V a.c. 3P+N 50/60 Hz	3 fase + N	5 x 6	H05RR
	415V a.c. 3P+N 50/60 Hz	3 fase + N	5 x 10	H05RR
PDI10..	220-240V a.c. 1P+N 50/60 Hz	1 fase + N	3 x 10	H07RN
	380V a.c. 2P+N 50/60 Hz	2 fase + N	4 x 6	H05RR
	400-415V a.c. 2P+N 50/60 Hz	2 fase + N	4 x 10	H05RR
	380V a.c. 3P+N 50/60 Hz	3 fase + N	5 x 6	H05RR
	400-415V a.c. 3P+N 50/60 Hz	3 fase + N	5 x 10	H05RR
PI127.. MI127..	220-240V a.c. 1P+N 50/60 Hz	1 fase + N	3 x 10	H07RN
	380-415V a.c. 2P+N 50/60 Hz	2 fase + N	4 x 10	H05RR
	380V a.c. 3P+N 50/60 Hz	3 fase + N	5 x 6	H05RR
PMI09S3	220-240V a.c. 1P+N 50/60 Hz	1 fase + N	3 x 10	H07RN
	380-415V a.c. 2P+N 50/60 Hz	2 fase + N	4 x 6	H05RR
	380-415V a.c. 3P+N 50/60 Hz	3 fase + N	5 x 4	H05RR
PMI127S3	220-240V a.c. 1P+N 50/60 Hz	1 fase + N	3 x 10	H07RN
	380-415V a.c. 2P+N 50/60 Hz	2 fase + N	4 x 10	H05RR
	380-415V a.c. 3P+N 50/60 Hz	3 fase + N	5 x 4	H05RR

INSTALLATION

Electrical connection (with gas top)

	240 a.c. 1P+N+T 50Hz	240 a.c. 3P+T 50Hz	415 a.c. 2P+N+T 50Hz	415 a.c. 3P+N+T 50Hz
L06(W/F/L/N/S)(MP/M3)	3 x 1,5 mm ² H05RR-F			
P06(F/L/W/N/S)E3 - N06(W/Q/N/QN)E3 P06(F/L/W/N/S)DE3 - N06(W/Q/N/QN)DE3	3 x 1,5 mm ² H05RR-F			
P07(F/L/W/N/S)E3 - N07(W/Q/N/QN)E3 P07(F/L/W/N/S)DE3 - N07(W/Q/N/QN)DE3	3 x 1,5 mm ² H05RR-F			
P08(P)(F/L/W/N/S)E3 - N08(P)(W/Q/N/QN)E3 P08(C)(F/L/W/N/S)E3 - N08(C)(W/Q/N/QN)E3 P08(PD)(F/L/W/N/S)E3 - N08(PD)(W/Q/N/QN)E3 P08(D)(F/L/W/N/S)E3 - N08(D)(W/Q/N/QN)E3	3 x 1,5 mm ² H05RR-F			
V09(6/C)SV - V09(6/C)V V09(6/C)SVP - V09(6/C)VP V09(6/C)SMP - V09(6/C)MP	3 x 1,5 mm ² H05RR-F			
L09(6)(W/F/L/N/S)(MP/M3) - L09(F)(W/F/L/N/S)(MP/M3) L09(C)(W/F/L/N/S)(MP/M3)	3 x 1,5 mm ² H05RR-F			
P09(P)(F/L/W/N/S)E3 - N09(P)(W/Q/N/QN)E3 P09(6)(F/L/W/N/S)E3 - N09(6)(W/Q/N/QN)E3 P09(F)(F/L/W/N/S)E3 - N09(F)(W/Q/N/QN)E3 P09(PD)(F/L/W/N/S)E3 - N09(PD)(W/Q/N/QN)E3 P09(6D)(F/L/W/N/S)E3 - N09(6D)(W/Q/N/QN)E3 P09(FD)(F/L/W/N/S)E3 - N09(FD)(W/Q/N/QN)E3 P09(6DD/FDD)(L/W)MP - P09(6DD/FDD)(L/W)M3	3 x 1,5 mm ² H05RR-F			
P09(I)(F/L/W/N/S)E3 - N09(I)(W/Q/N/QN)E3 P09(ID)(F/L/W/N/S)E3 - N09(ID)(W/Q/N/QN)E3	3 x 4 mm ² H05RR-F	4 x 1,5 mm ² H05RR-F	4 x 1,5 mm ² H05RR-F	
M07D(N/W/Q/QN)E3	3 x 1,5 mm ² H05RR-F			
M30D(N/W/Q/QN)E3	3 x 1,5 mm ² H05RR-F			
M09(PD)(N/W/Q/QN)E3 - M09(6D)(N/W/Q/QN)E3 M09(FD)(N/W/Q/QN)E3	3 x 1,5 mm ² H05RR-F			
M09(ID)(N/W/Q/QN)E3	3 x 4 mm ² H05RR-F	4 x 1,5 mm ² H05RR-F	4 x 1,5 mm ² H05RR-F	
LD09(6)(W/F/L/N/S)(MP/M3) - LD09(C)(W/F/L/N/S)(MP/M3) LD09(F)(W/F/L/N/S)(MP/M3)	3 x 2,5 mm ² H05RR-F	4 x 1,5 mm ² H05RR-F	4 x 1,5 mm ² H05RR-F	
PD09(P)(F/L/W/N/S)E3 - ND09(P)(W/Q/N/QN)E3 PD09(6)(F/L/W/N/S)E3 - ND09(6)(W/Q/N/QN)E3 PD09(F)(F/L/W/N/S)E3 - ND09(F)(W/Q/N/QN)E3 PD09(PD)(F/L/W/N/S)E3 - ND09(PD)(W/Q/N/QN)E3 PD09(6D)(F/L/W/N/S)E3 - ND09(6D)(W/Q/N/QN)E3 PD09(FD)(F/L/W/N/S)E3 - ND09(FD)(W/Q/N/QN)E3	3 x 2,5 mm ² H05RR-F	4 x 1,5 mm ² H05RR-F	4 x 1,5 mm ² H05RR-F	
PD09(I)(F/L/W/N/S)E3 - ND09(I)(W/Q/N/QN)E3 PD09(ID)(F/L/W/N/S)E3 - ND09(ID)(W/Q/N/QN)E3	3 x 10 mm ² H07RR-F	4 x 2,5 mm ² H05RR-F	4 x 2,5 mm ² H05RR-F	5 x 1,5 mm ² H05RR-F
LD10(6)(W/F/L/N/S)(MP/M3) - LD10(C)(W/F/L/N/S)(MP/M3) LD10(F)(W/F/L/N/S)(MP/M3)	3 x 2,5 mm ² H05RR-F	4 x 1,5 mm ² H05RR-F	4 x 1,5 mm ² H05RR-F	
MD10(6D)(N/W/Q/QN)E3 - MD10(FD)(N/W/Q/QN)E3 MD10(SD)(N/W/Q/QN)E3	3 x 2,5 mm ² H05RR-F	4 x 1,5 mm ² H05RR-F	4 x 1,5 mm ² H05RR-F	
MD10(ID)(N/W/Q/QN)E3	3 x 10 mm ² H07RR-F	4 x 2,5 mm ² H05RR-F	4 x 2,5 mm ² H05RR-F	5 x 1,5 mm ² H05RR-F
PD10(6)(F/L/W/N/S)E3 - ND10(6)(W/Q/N/QN)E3 PD10(F)(F/L/W/N/S)E3 - ND10(F)(W/Q/N/QN)E3 PD10(S)(F/L/W/N/S)E3 - ND10(S)(W/Q/N/QN)E3 PD10(6D)(F/L/W/N/S)E3 - ND10(6D)(W/Q/N/QN)E3 PD10(FD)(F/L/W/N/S)E3 - ND10(FD)(W/Q/N/QN)E3 PD10(SD)(F/L/W/N/S)E3 - ND10(SD)(W/Q/N/QN)E3	3 x 4 mm ² H05RR-F	4 x 1,5 mm ² H05RR-F	4 x 1,5 mm ² H05RR-F	
PD10(I)(F/L/W/N/S)E3 - ND10(I)(W/Q/N/QN)E3 PD10(ID)(F/L/W/N/S)E3 - ND10(ID)(W/Q/N/QN)E3	3 x 10 mm ² H07RR-F	4 x 4 mm ² H05RR-F	4 x 4 mm ² H05RR-F	5 x 1,5 mm ² H05RR-F
L12(F)(W/F/L/N/S)(MP/M3) - L12(8)(W/F/L/N/S)(MP/M3)	3 x 2,5 mm ² H05RR-F	4 x 1,5 mm ² H05RR-F	4 x 1,5 mm ² H05RR-F	
P12(FI)(F/L/W/N/S)E3 - N12(FI)(W/Q/N/QN)E3 P12(I)(F/L/W/N/S)E3 - N12(I)(W/Q/N/QN)E3 P12(FID)(F/L/W/N/S)E3 - N12(FID)(W/Q/N/QN)E3 P12(ID)(F/L/W/N/S)E3 - N12(ID)(W/Q/N/QN)E3	3 x 10 mm ² H07RR-F	4 x 4 mm ² H05RR-F	4 x 4 mm ² H05RR-F	5 x 1,5 mm ² H05RR-F
P12(7)(F/L/W/N/S)E3 - N12(7)(W/Q/N/QN)E3 P12(F)(F/L/W/N/S)E3 - N12(F)(W/Q/N/QN)E3 P12(8)(F/L/W/N/S)E3 - N12(8)(W/Q/N/QN)E3 P12(S)(F/L/W/N/S)E3 - N12(S)(W/Q/N/QN)E3 P12(7D)(F/L/W/N/S)E3 - N12(7D)(W/Q/N/QN)E3 P12(FD)(F/L/W/N/S)E3 - N12(FD)(W/Q/N/QN)E3 P12(8D)(F/L/W/N/S)E3 - N12(8D)(W/Q/N/QN)E3 P12(SD)(F/L/W/N/S)E3 - N12(SD)(W/Q/N/QN)E3 P12(8DD/FDD)(L/W)MP - P12(8DD/FDD)(L/W)M3	3 x 4 mm ² H05RR-F	4 x 1,5 mm ² H05RR-F	4 x 1,5 mm ² H05RR-F	
M12(7D)(N/W/Q/QN)E3 - M12(FD)(N/W/Q/QN)E3 M12(8D)(N/W/Q/QN)E3 - M12(SD)(N/W/Q/QN)E3	3 x 4 mm ² H05RR-F	4 x 1,5 mm ² H05RR-F	4 x 1,5 mm ² H05RR-F	
M12(FID)(N/W/Q/QN)E3 - M12(ID)(N/W/Q/QN)E3	3 x 10 mm ² H07RR-F	4 x 4 mm ² H05RR-F	4 x 4 mm ² H05RR-F	5 x 1,5 mm ² H05RR-F
P15(F)(F/L/W/N/S)E3 - N15(F)(W/Q/N/QN)E3 P15(S)(F/L/W/N/S)E3 - N15(S)(W/Q/N/QN)E3 P15(9)(F/L/W/N/S)E3 - N15(9)(W/Q/N/QN)E3 P15(FD)(F/L/W/N/S)E3 - N15(FD)(W/Q/N/QN)E3 P15(FSD)(F/L/W/N/S)E3 - N15(FSD)(W/Q/N/QN)E3 P15(SD)(F/L/W/N/S)E3 - N15(SD)(W/Q/N/QN)E3 P15(9D)(F/L/W/N/S)E3 - N15(9D)(W/Q/N/QN)E3	3 x 4 mm ² H05RR-F	4 x 1,5 mm ² H05RR-F	4 x 1,5 mm ² H05RR-F	
M15(FD)(N/W/Q/QN)E3 - M15(FSD)(N/W/Q/QN)E3 M15(SD)(N/W/Q/QN)E3 - M15(9D)(N/W/Q/QN)E3	3 x 4 mm ² H05RR-F	4 x 1,5 mm ² H05RR-F	4 x 1,5 mm ² H05RR-F	

INSTALLATION

Gas connection

This appliance must be installed by an authorised person in accordance with this instruction manual, AS/NZS 5601 Gas installations (installation and pipe sizing), local gas fitting regulations, local electrical regulations, local water regulations, local health regulations, Building Code of Australia and any other government authority.

This appliance is suitable for connection with rigid pipe. The isolating manual shut-off valve connection point must be accessible when the appliance is installed.

⚠ ATTENTION! THIS APPLIANCE IS NOT SUITABLE FOR CONNECTION WITH A HOSE ASSEMBLY

Natural Gas: the supplied regulator must be fitted to the appliance inlet connection. Gas pressure must be adjusted to 1.0 kPa when approximately 50% of the burners are on high flame.

ULPG: the supplied test point adaptor must be fitted to the appliance inlet connection. Gas pressure must be adjusted to 2.75 kPa.

Gas leakage and operation of the appliance must be tested by the installer before leaving. Check burner flames are blue in colour, stable and completely ignite at both high and low flame settings with no appreciable yellow tipping, carbon deposition, lifting, floating, lighting back or objectionable odour. Test burners individually and in combination. When satisfied with the operation of the cooker, please instruct the user on the correct method of operation.

Where the data plate is obscured by cabinetry when the cooker is in the installed position, place the supplied duplicate data plate to a suitable adjacent surface or within the instruction manual for future reference.

Removing Legs and placing oven on a plinth

If the legs are removed and the oven is placed on a plinth, then suitable ventilation from the plinth area is required. It is recommended that an air vent 20 mm wide and a length of 100mm less than the width of the oven it is located at the rear in the base of the plinth. If the area under the plinth is sealed it is also recommended that an additional vent be included at the top of kick panel under the plinth to provide adequate circulation. The vent size should be 10mm high and 100mm less than the width of the oven.

⚠ ATTENTION! Any maintenance operation, etc. It must be carried out by an authorized technician after disconnecting the appliance from the mains and closing the gas supply.

Location of inlet connection point for hose assemblies

- 450 mm to 550 mm from the floor and 200 mm to 300 mm from the left-hand side of the appliance as viewed from the front;

- the hose connection on the appliance shall face downwards;
- an anchor point shall be provided on the appliance so that a restraining device can be fitted to restrict the appliance movement to no more than 80 % of the hose length;)

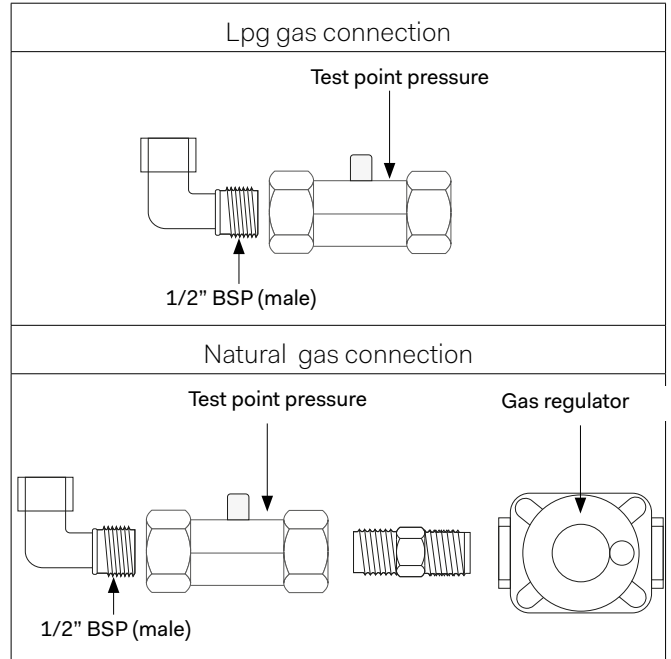

⚠ ATTENTION! THIS APPLIANCE IS NOT SUITABLE FOR CONNECTION WITH A HOSE ASSEMBLY
Fitting the restraining chain for gas connection
The restraining chain MUST be fitted like these pictures. It is recommended to connect the tightness of the connections with special foaming (NO FLAME).

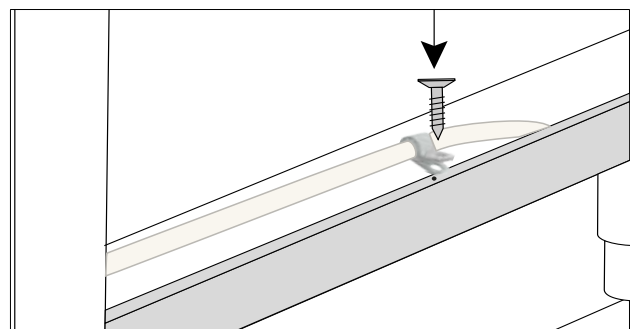
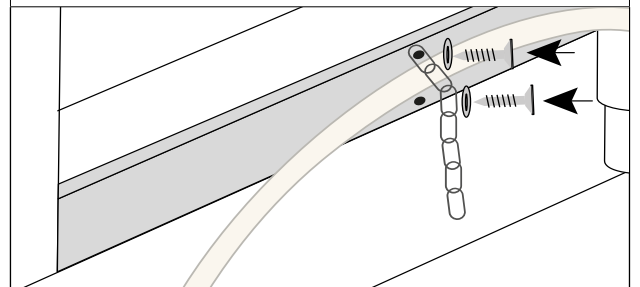

Transformation for Other Gases

The appliance is delivered to operate as indicated on the label on the appliance. If a transformation with other gases is necessary, proceed as described in the paragraph "adjustment and/or adaptation to different types of gases"

⚠ ATTENTION

Any maintenance operation, etc. It must be carried out by an authorized technician after disconnecting the appliance from the mains and closing the gas supply.

INSTALLATION

Adjustment

Adjustment and/or adaptation to different types of gas

SR - R - P

1. Remove the grid and burners from the hob.
2. SR - R - P Burners: Unscrew the "U" injectors using a 7 mm wrench and replace them with those intended for the new gas, according to the table below.

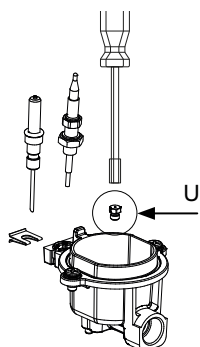

DCC/DUAL

1. DCC/DUAL Burners: Unscrew the two screws and remove the cover.
2. Unscrew the "U" injectors using a 7 mm wrench and replace them with those intended for the new gas according to tables No. 1 and No. 2.

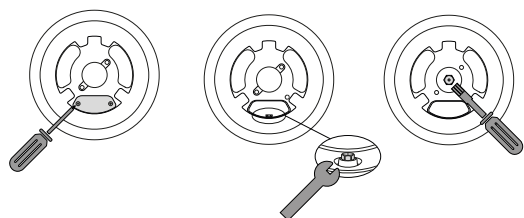

Minimum Adjustment

Control adjustment

When installing the appliance, it is necessary to check that the minimum setting of the burners on the hob and in the oven is correctly adjusted. If the type of gas is changed, the minimum adjustment is essential. The adjustment is carried out as follows.

Hob burners

1. Turn on one burner at a time and set the flame to maximum.
2. Remove the corresponding gas valve knob and insert a screwdriver either into the valve's final part or into the screw.

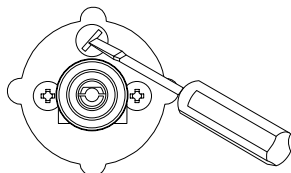

DUAL

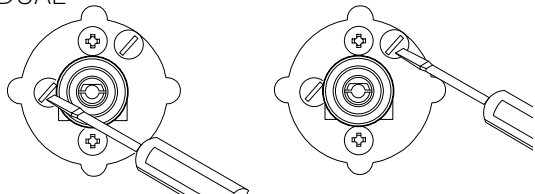

3. Set the valve to the minimum position.
4. Unscrew by turning left to increase the flame, or screw in to the right to decrease it.
5. If using liquefied gas (Butane - Propane), the adjustment screw should be fully screwed in.

ADJUSTMENT

Burner chart

PROFESSIONAL / MAJESTIC						
	NATURAL GAS			ULPG		
Burner	Injector Size (mm)	Nominal Gas Consumption (MJ/h)	Pressure (kPa)	Injector Size (mm)	Nominal Gas Consumption (MJ/h)	Pressure (kPa)
DCC wok	2.00	18.00	1.00	1.15	18.0	2.75
LARGE - R	1.55	12.00	1.00	0.95	12.0	2.75
LARGE - R under fry-top	1.40	10.00	1.0	0.85	10.0	2.75
MEDIUM - SR	1.25	7.5	1.00	0.74	7.0	2.75
FISH - P	1.55	12.5	1.00	0.95	13	2.75
SIMMER PLATE - C.d.F.	1.40	10.0	1.00	0.83	9.0	2.75
DUAL WOK	0.80 1.75	Inner: 3.3 Total: 17.0	1.00	0.50 1.10	Inner: 3.3 Total: 20.0	2.75

PROLINE						
	NATURAL GAS			ULPG		
Burner	Injector Size (mm)	Nominal Gas Consumption (MJ/h)	Pressure (kPa)	Injector Size (mm)	Nominal Gas Consumption (MJ/h)	Pressure (kPa)
DCC wok	2.00	18.0	1.00	1.15	18.0	2.75
LARGE - R	1.55	12.0	1.00	0.95	12.0	2.75
LARGE - R under fry-top	1.40	10.0	1.0	0.85	10.0	2.75
MEDIUM - SR	1.25	7.5	1.00	0.74	7.0	2.75

PANORAMAGIC					
Burner	Injector Size (mm)	NG consumption @ 1kPa (MJ/h)	Injector Size (mm)	NG consumption @ 2.75kPa (MJ/h)	
DUAL wok	1.75 / 0.80	17.0	1.10 / 0.50	20.0	
Wok DCC	1.95	17.0	1.15	18.0	
LARGE - R	1.55	12.0	0.95	12.0	
LARGE - R1 under fry-top	1.40	10.0	0.85	10.0	
MEDIUM - SR	1.25	7.5	0.74	7.0	
Tepanyaki Plate (medium and large burner)	1.25, 1.40	7.5 + 10	0.85, 0.74	7.0 + 10	

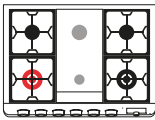
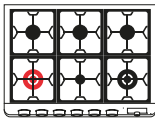
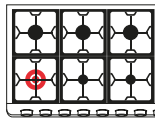
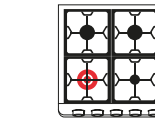
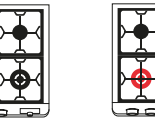
R R1 R	R R R	R R R R	R R R1 R	R R1 R R
				
DUAL SR DCC	DUAL SR DCC	DUAL SR SR DCC	DUAL SR SR DCC	DUAL SR SR DCC

INSTALLATION

Electrical connections and installation diagrams

E = Electrical connection

G = Gas connection

Majestic

Mod	A (mm)	B (mm)	C (mm)	Mod	A (mm)	B (mm)	C (mm)
M07	205	130	700	M12	150	110	1216
M09	190	140	911	M15	195	150	1511
MD10	140	95	1000	M30	120	80	760

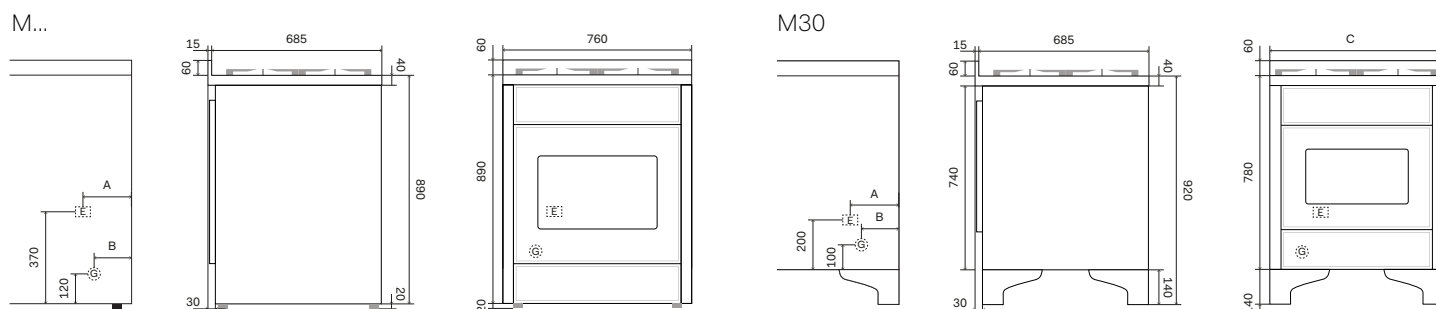

Nostalgie, Professional Plus, Pro Line

Mod	A (mm)	B (mm)	C (mm)	Mod	A (mm)	B (mm)	C (mm)
P06N / P06W / L06	130	80	600	PD10N / PD10W / LD10	140	80	1000
P07N / P07W	190	150	700	P12N / P12W / L12	225	90	1200
P09N / P09W / L09	240	150	900	P15N / P15W	200	135	1500
PD09N / PD09W / LD09	140	80	900	P36N / P36W	200	150	911

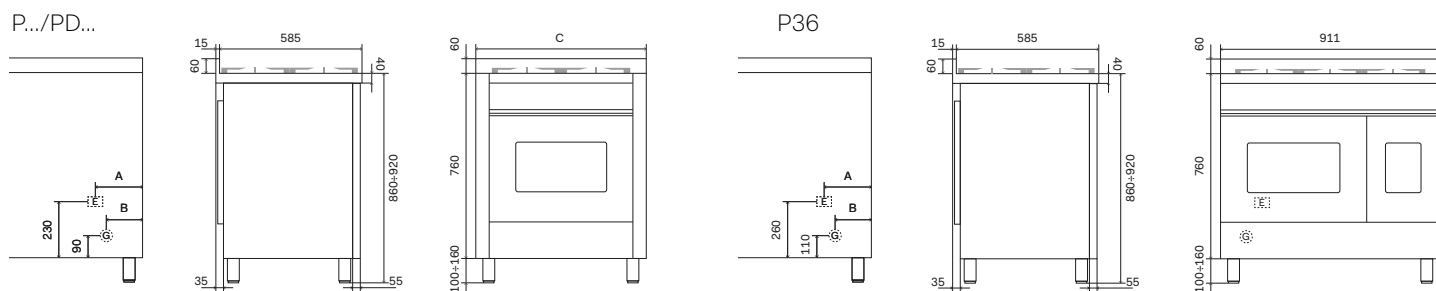

Panoramagic

Mod	A (mm)	B (mm)	C (mm)	e (mm)	g (mm)
PM09	455	185	911	205	80
PMI09	350		911	205	
PM12	455	192	1216	155	150

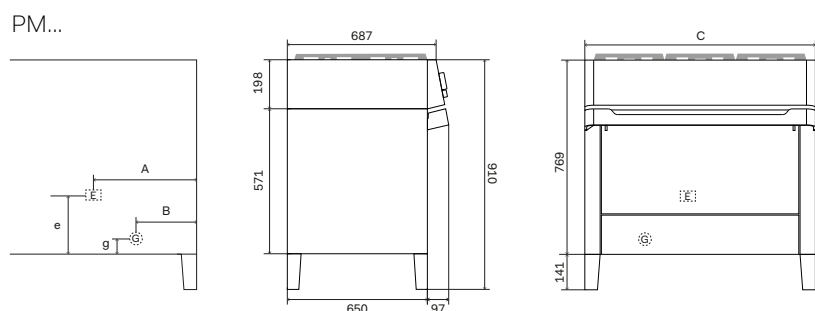

INSTALLATION

Key

00	Black
11	Brown
22	Red
33	White
44	Yellow
45	Yellow-green
55	Grey
66	Blue
AA	Electrical ignition transformer
C	Commutator
CA	Capacitor 1,05 µF
CCDF	Fry-Top switch
CP	Cooking probe
DM	Dumper microonde
DV	Dumper vapore
DS1	Burner control
DU	Wax thermal actuator discharging steam
DY	Display
EL	Solenoid valve
EN	Encoder
F	Phase
F1	Phase 1
FLC	LC Filter
FUSE	Fuse 10A
HVD	High voltage diode
K1	Earth wire terminal block
K2	Earth wire lower resistance
K3	Earth wire oven fan
K4	Earth wire circulating resistance
K5	Earth wire upper resistance
K6	Earth wire oven light 1
K7	Earth wire oven light 2
K8	Earth wire roaster
K9	Earth wire cooling fan.
K10	Earth wire commutator
K11	Earth wire oven thermostat
K12	Earth wire programmer/timer
K13	Earth wire grill resistance
K14	Earth wire piastra elettrica
K15	Earth wire frame
K16	Earth wire barbecue resistance
K17	Earth wire resistenza friggitrice
L1	Oven light
L2	Oven light
M	Terminal block
MA	Electrical ignition microswitch
MD	Grill microswitch
MG	Rotisserie
MGT	Magnetron
MP	Door microswitch
MMO	Monitor microswitch for microwave
MPR	Primary microswitch for microwave
MSEC	Secondary microswitch for microwave

MT	Micro cooling fan
MTK	Water loading tank microswitch
MVT	Cooling fan microswitch
N	Neutral
NTC	Temperature probe
P	Timer\Clock - Timer\Programmer
PB	Power board
PD	Pump
PE	Electric hotplate
PT1000	Temperature probe
R1	Upper resistance
R2	Lower resistance
R3	Grill resistance
R4	Circulating resistance
R5	Barbecue resistance
R6	Fryer resistance
RC	Boiler heating element
RE	Energy controller
RL	Limit resistance
S1	Oven warning light
S2	Mains power warning light
S3	Grill warning light
S4	Cooling fan warning
S5	Barbecue warning light
S6	Electric hotplate warning light
S7	Rotisserie warning light
S8	Residual heat warning light
S9	Fryer warning light
SA	Power supply board
SD	Display board
SE	Auxiliary power board
SI	Interface board
SL	Water level detector
SP	Power board
SPI	Candela di accensione
SR	Safety Relay
SWD	Warming drawer control board
T	Grill thermostat
TCO\TC1	Safety thermostat 318 °C (TCO)
TSPO	Safety thermostat 90 °C
TF	Oven thermostat
TR	Fryer thermostat\ High voltage transformer
TS\TS1\ TS2	Safety thermostat
TST	Tangential motor safety thermostat
TT	Tangential thermostat
V\VR	Oven fan
VT	Cooler fan

INSTALLATION

Wiring diagrams

Quick Start

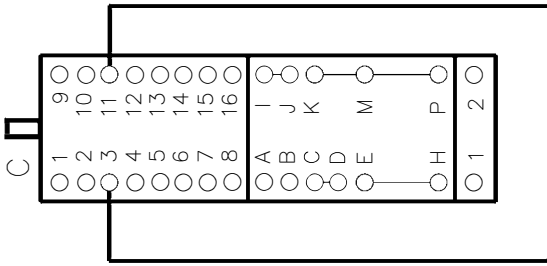

GAS HOB

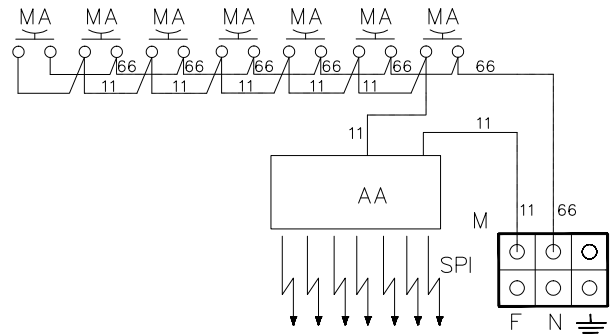

5 INDUCTION ZONES BASIC

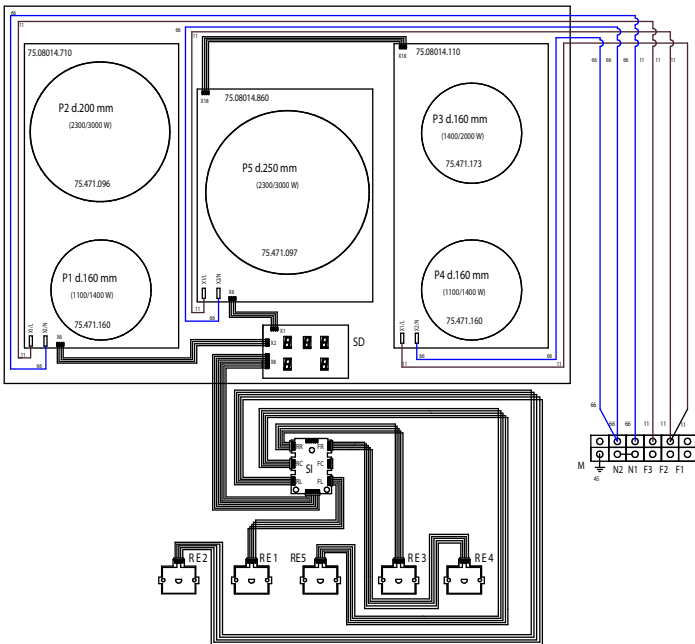

4 INDUCTION ZONES

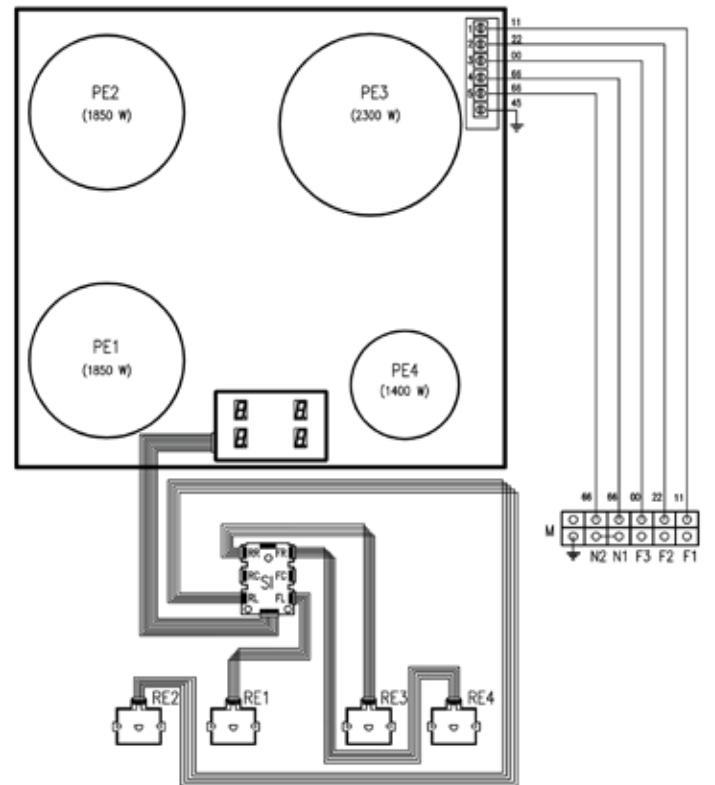

INSTALLATION

Wiring diagrams

6 INDUCTION ZONES

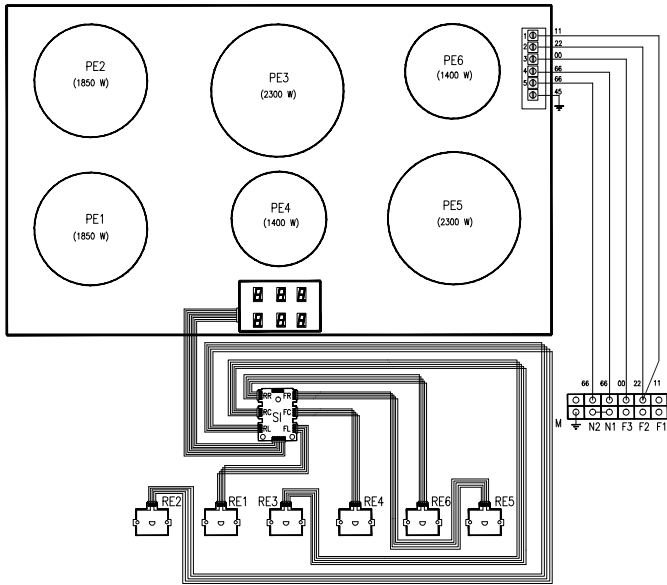

L/P (06-09)...MP

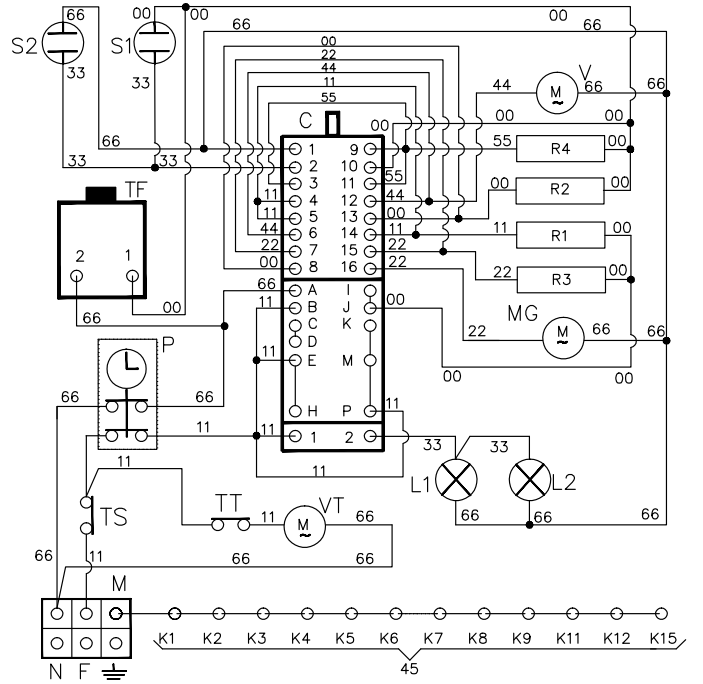

P091...E3

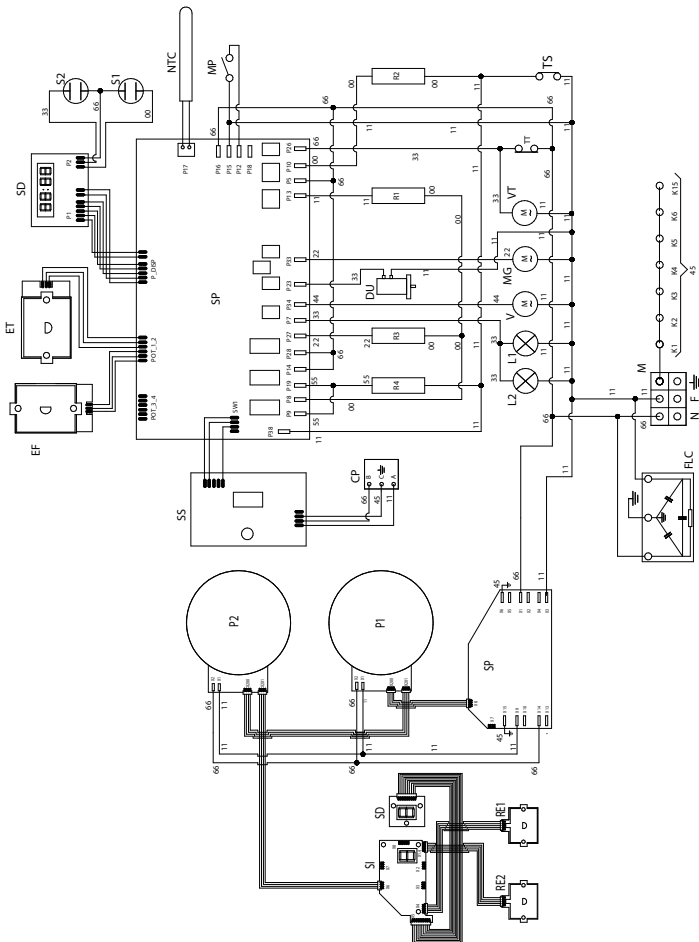

INSTALLATION

Wiring diagrams

7 INDUCTION ZONES

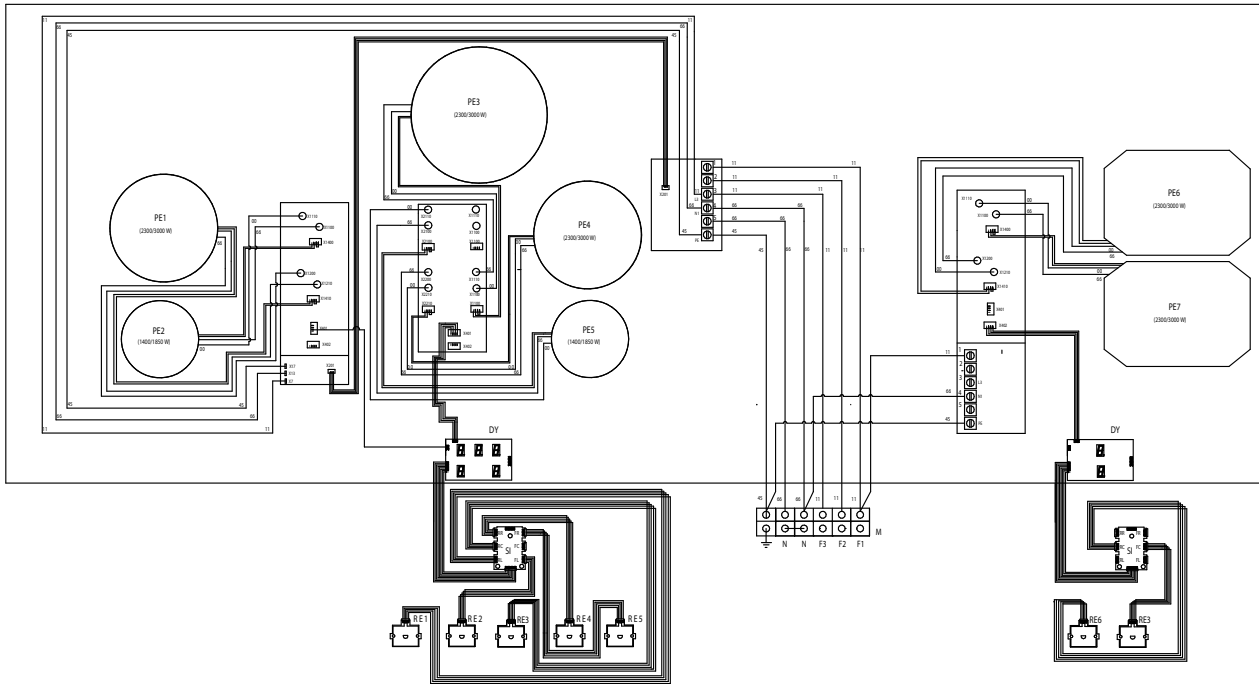

P (06-07-30"-08-09)...E3

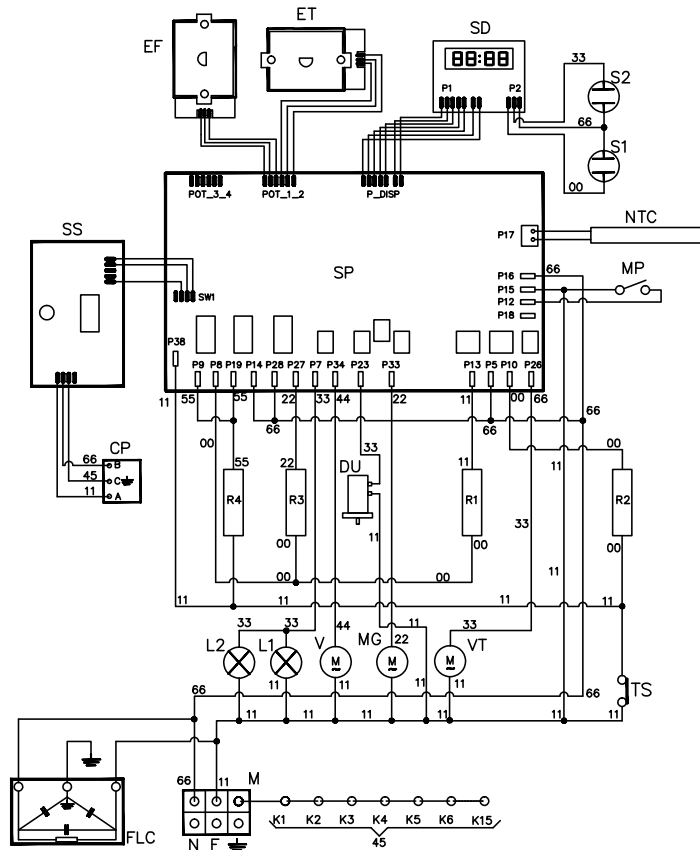

INSTALLATION

Wiring diagrams

L7P (06-09)...M3

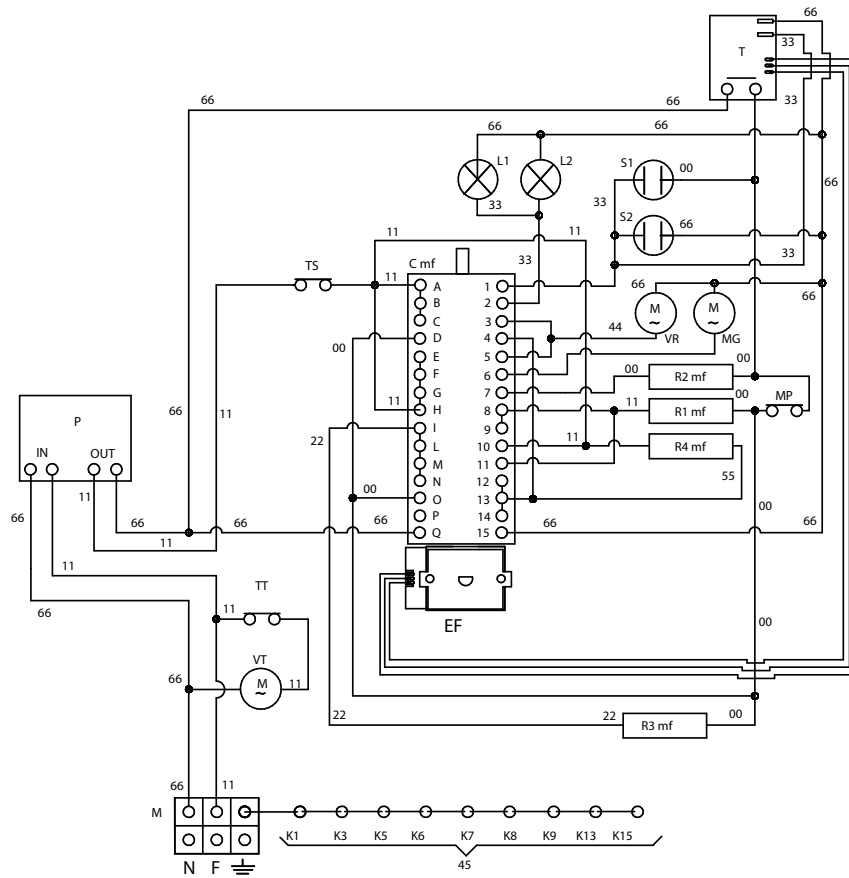

M (07-30"-09)...E3

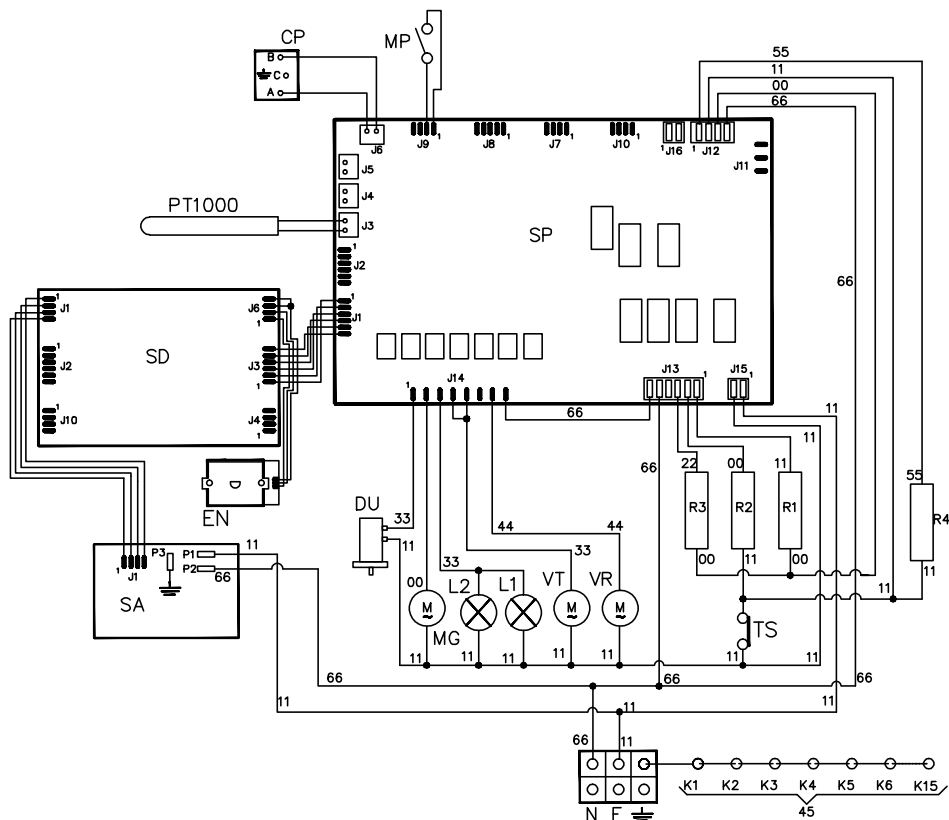

INSTALLATION

Wiring diagrams

M09I..E3

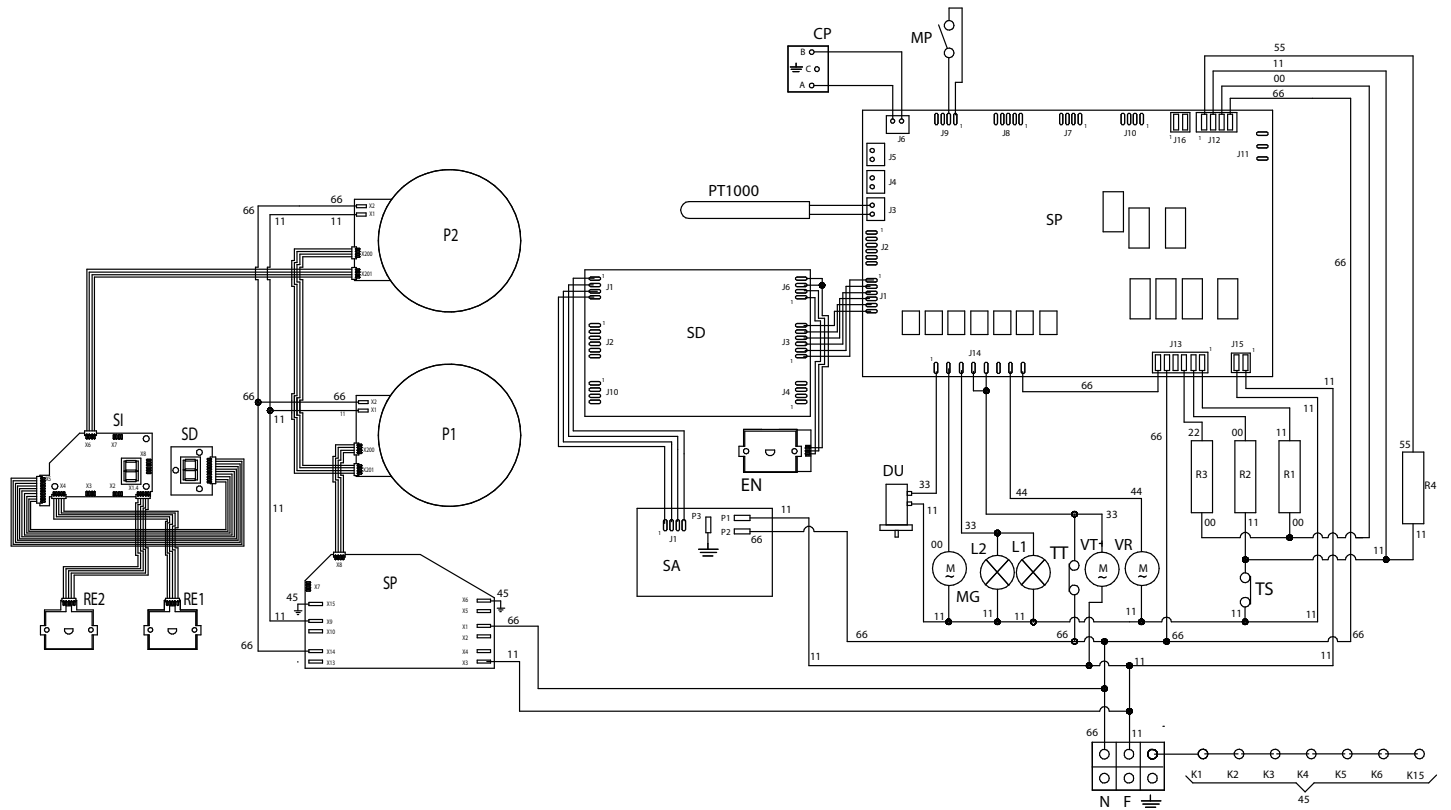

L/P 12...MP

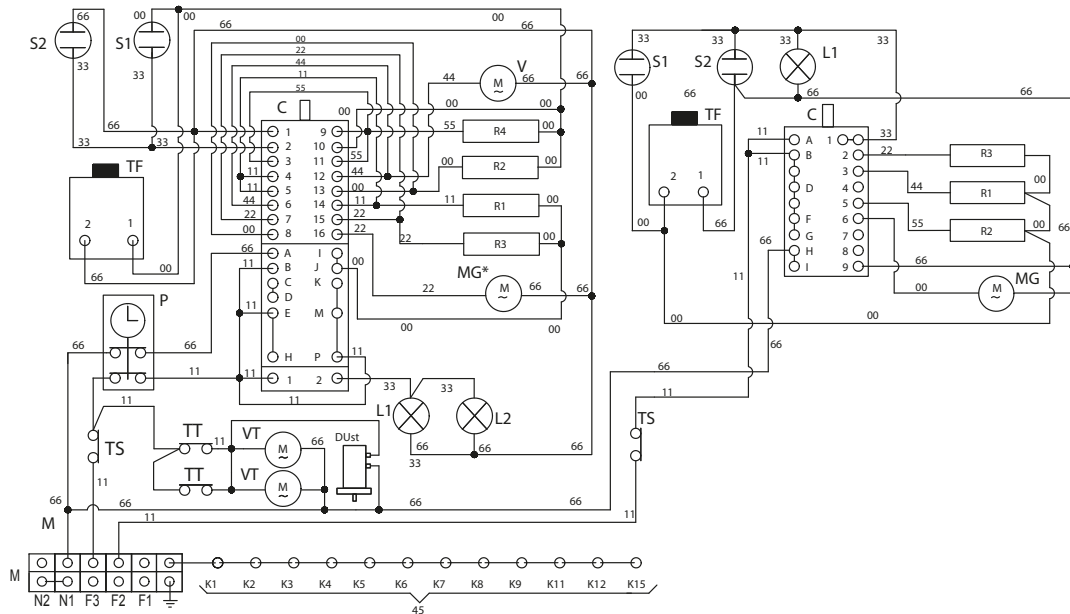

INSTALLATION

Wiring diagrams

L/P 12...M3

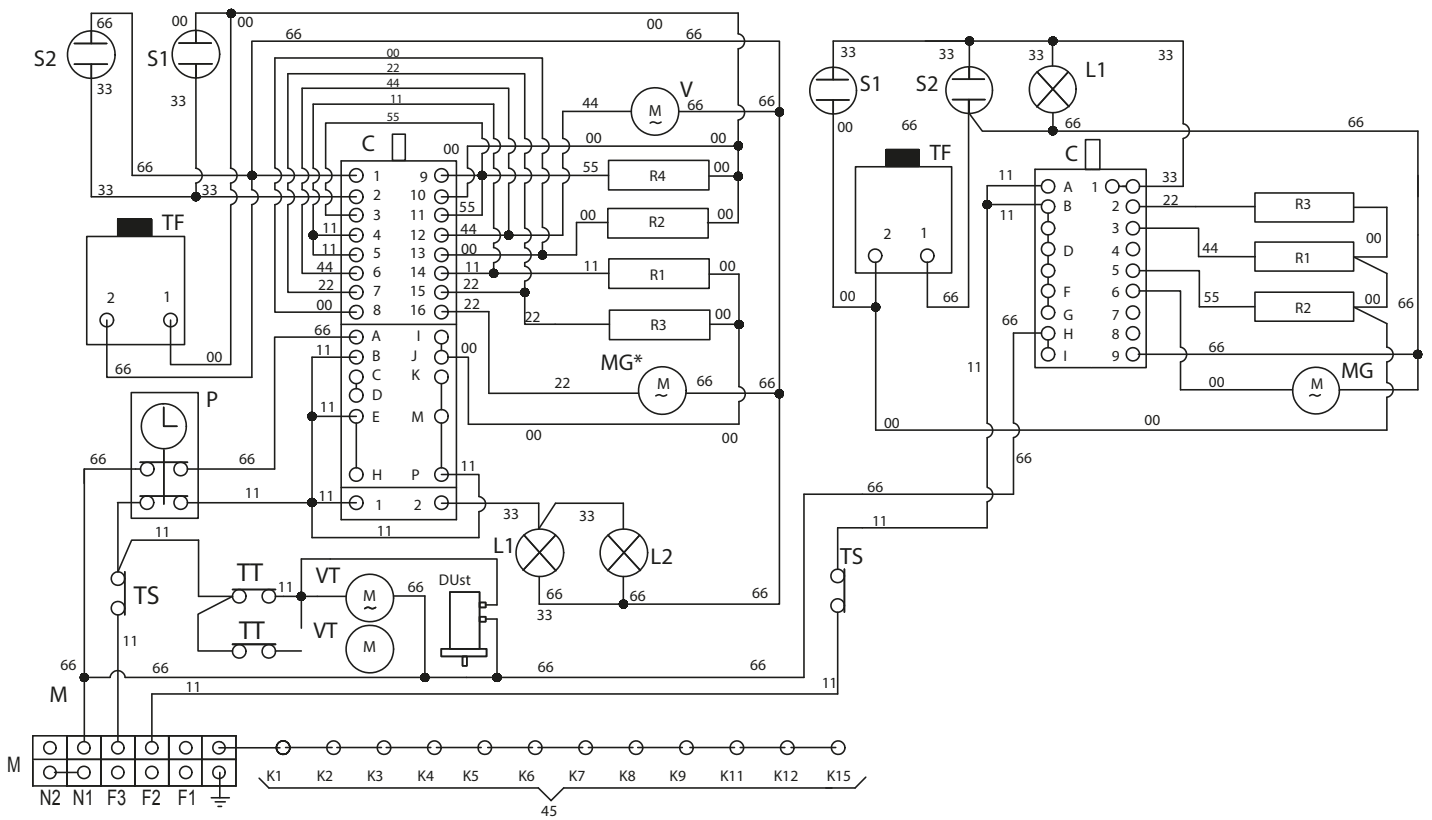

LD (09-10)...MP

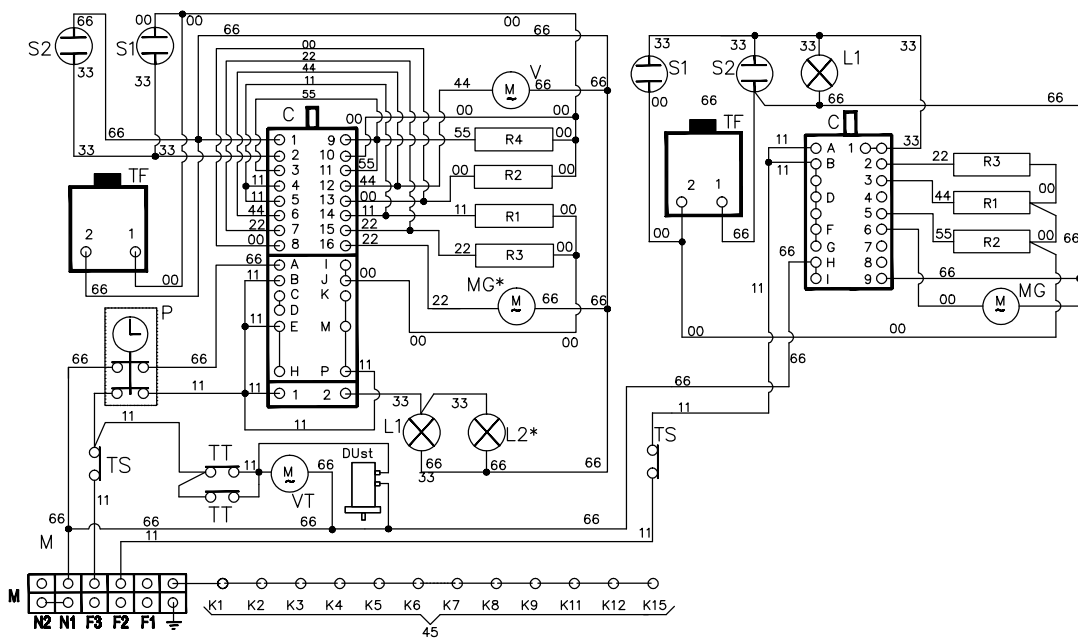

INSTALLATION

Wiring diagrams

LD (09-10)...M3

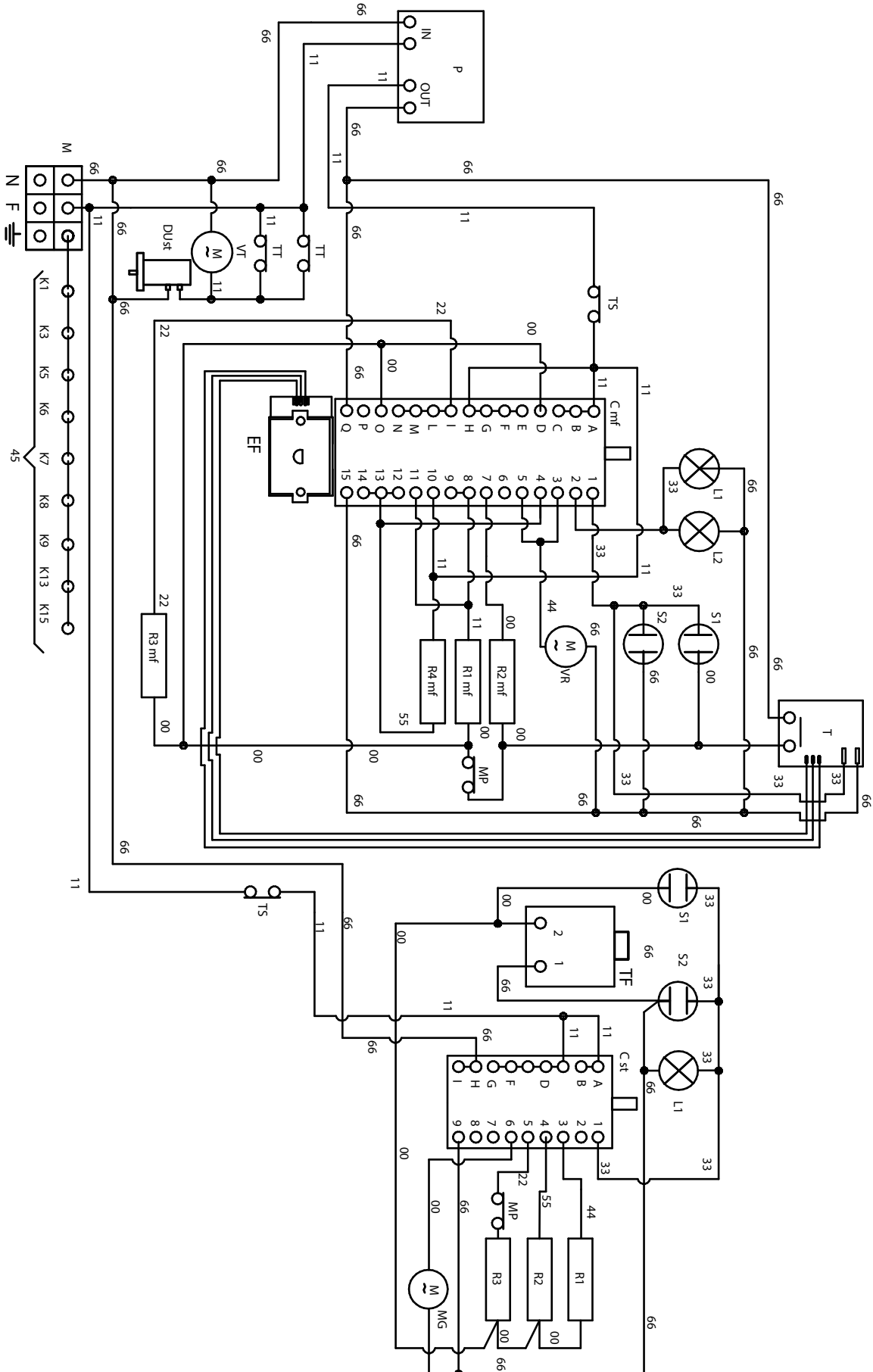

INSTALLATION

Wiring diagrams

M12...E3

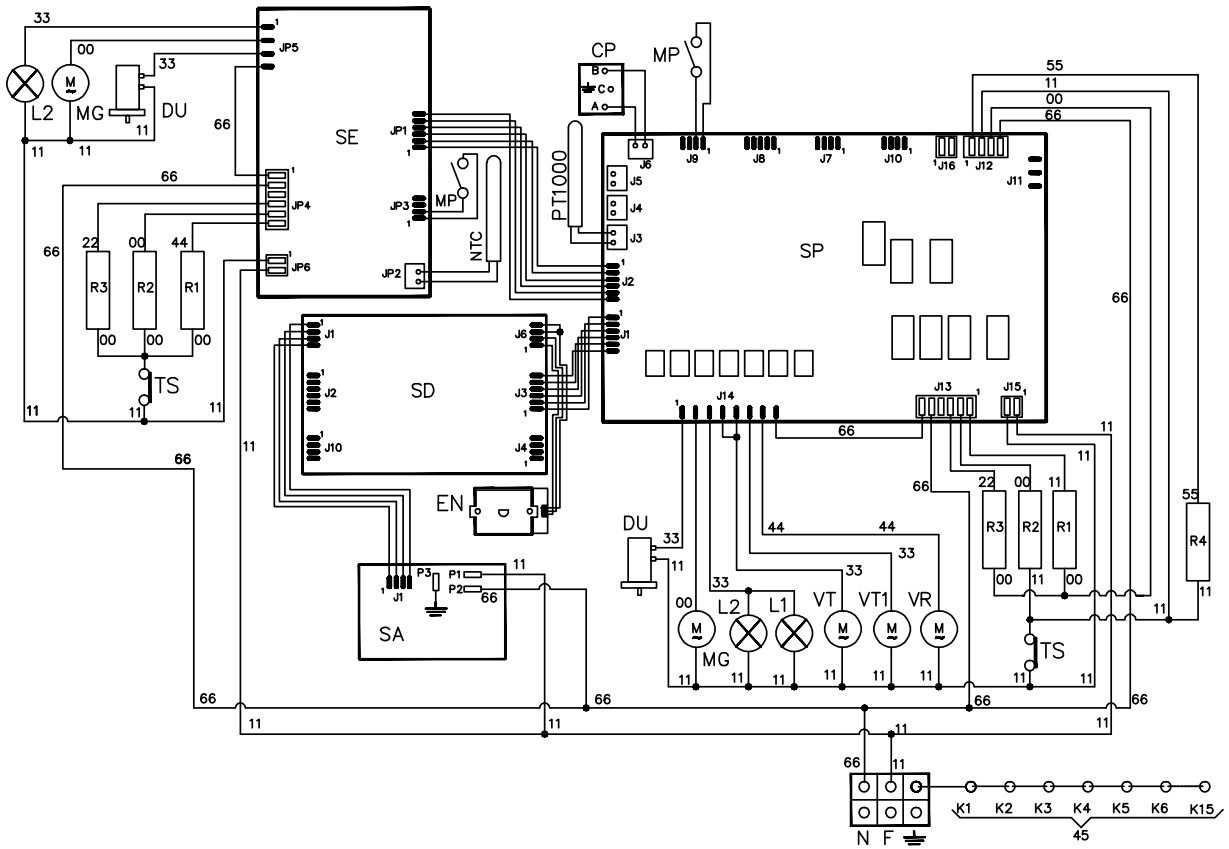

M12I...E3

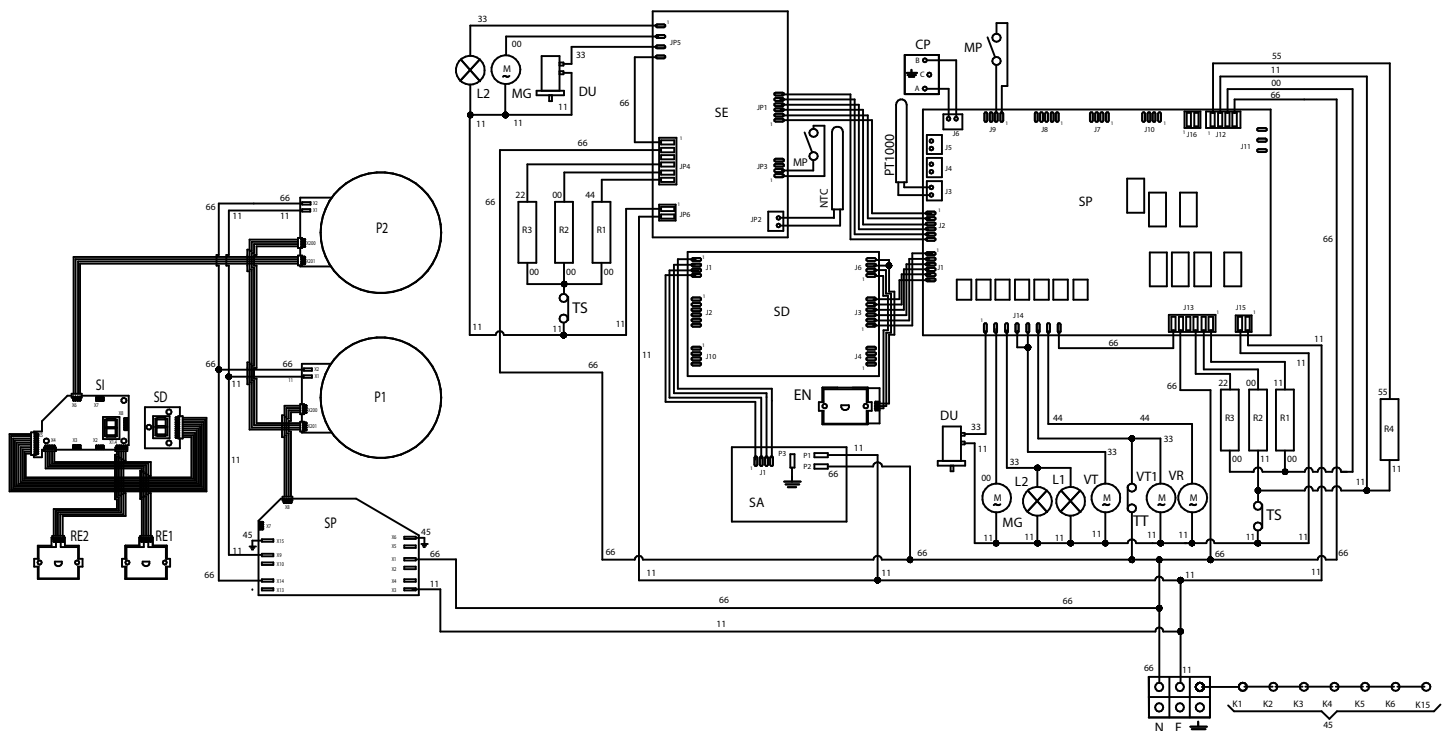

INSTALLAZIONE

Wiring diagrams

M15...E3

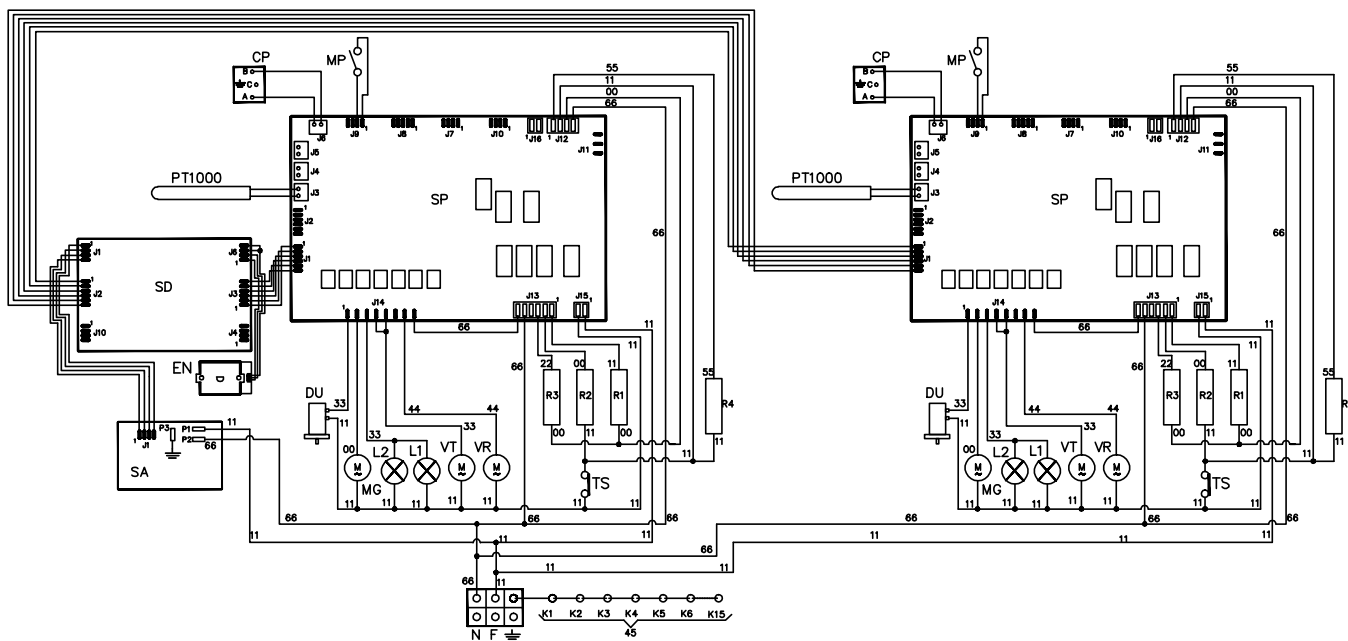

MD10...E3

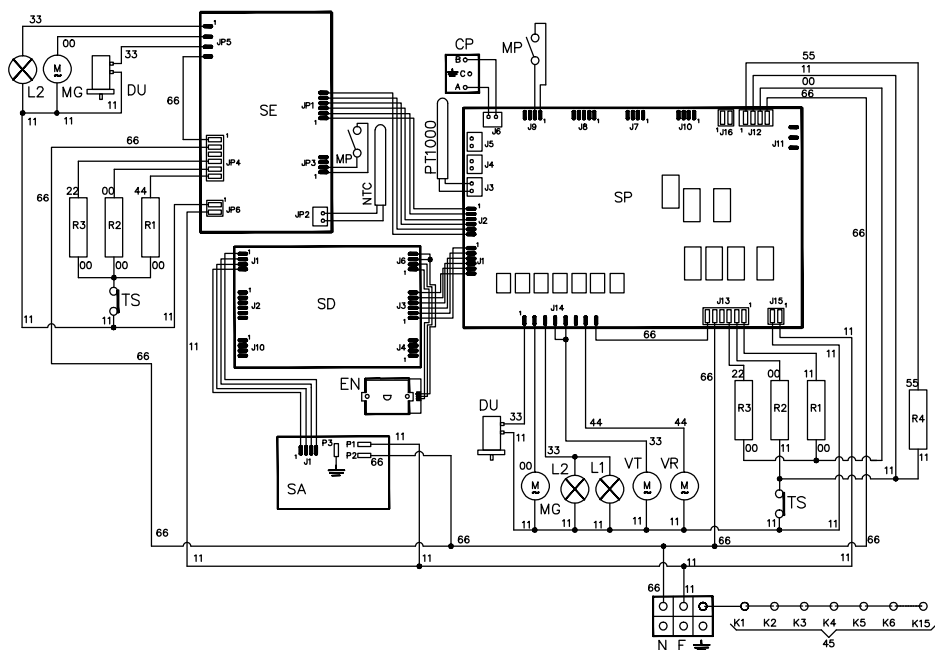

INSTALLAZIONE

Wiring diagrams

MD10I...E3

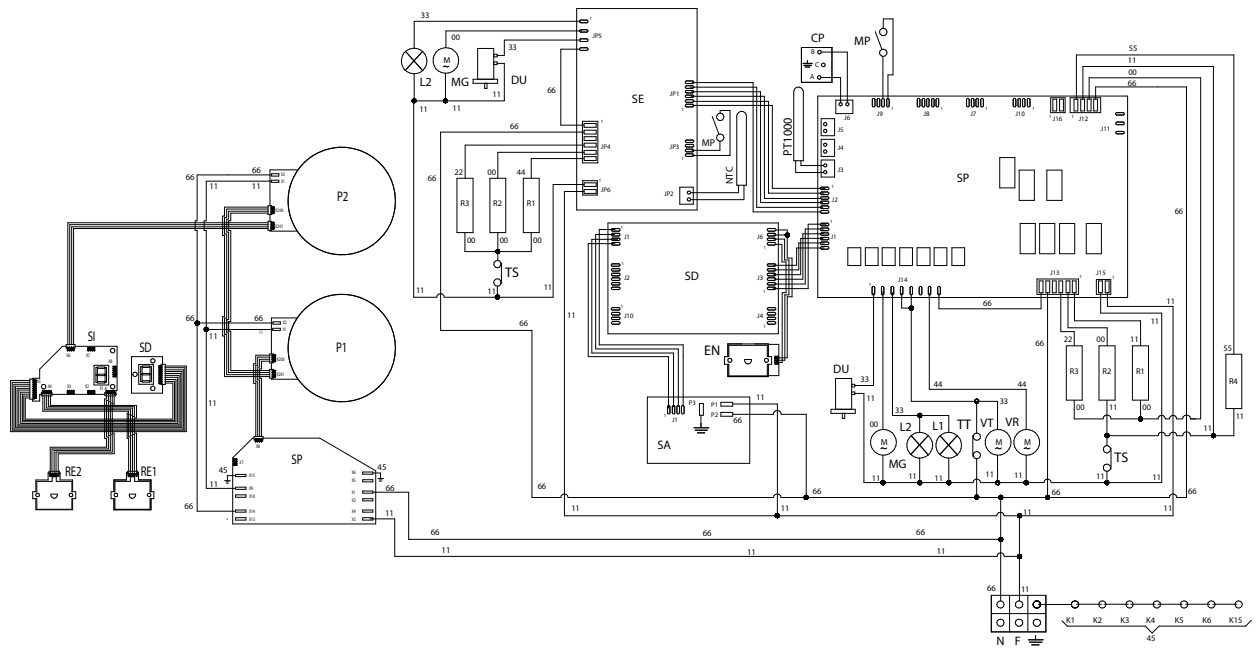

P12...IE3

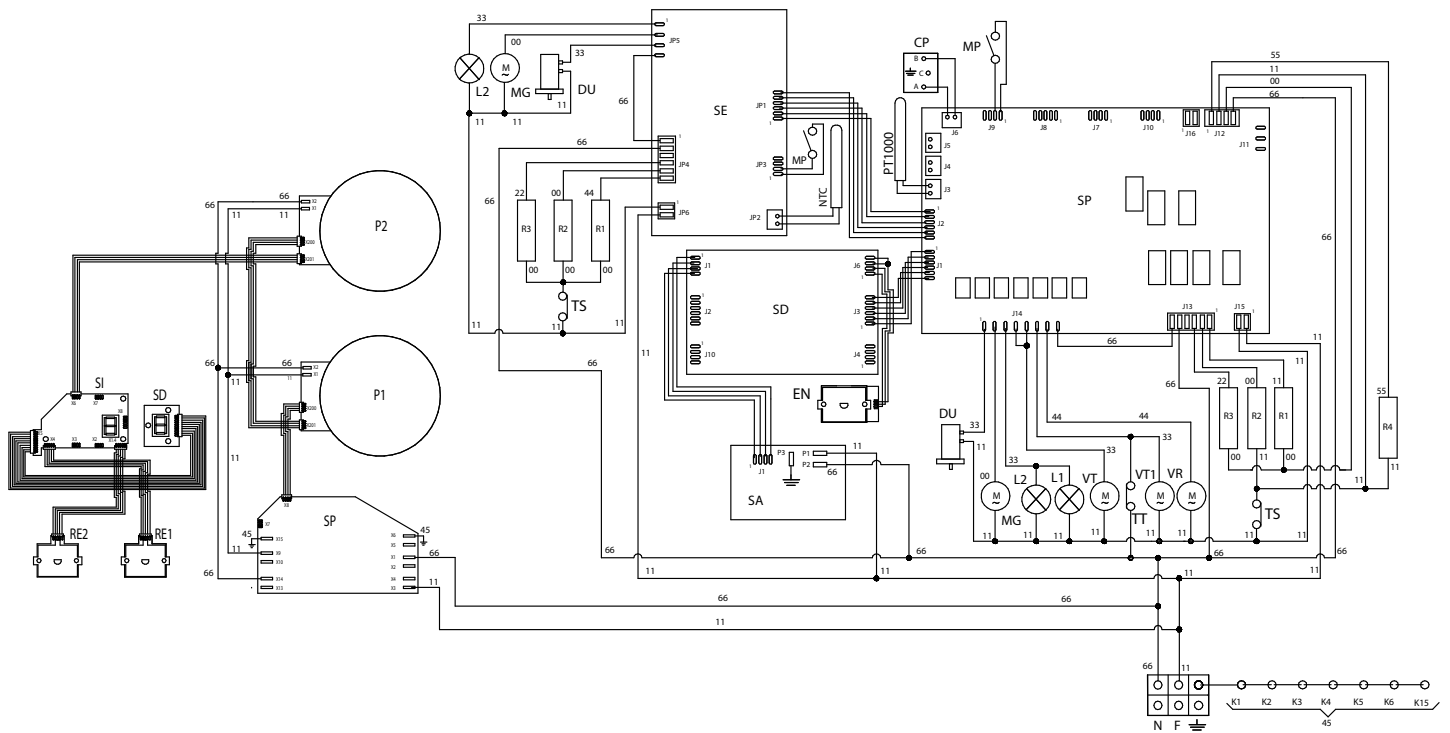

INSTALLATION

Wiring diagrams

P12...E3

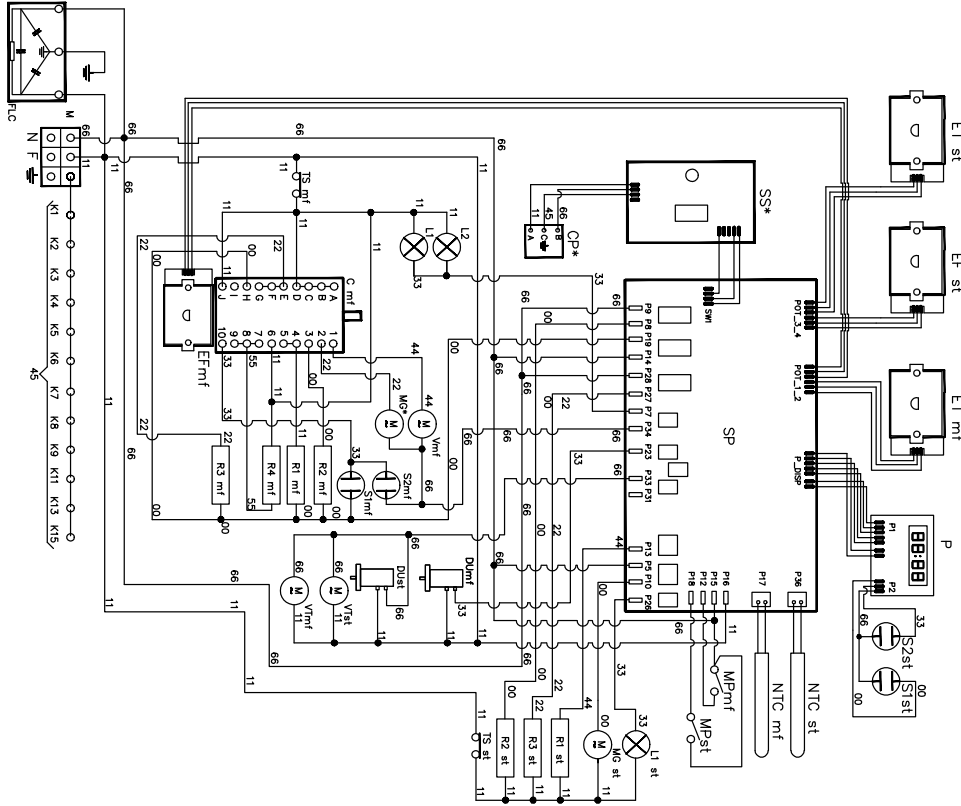

PD(09/10)I...E3

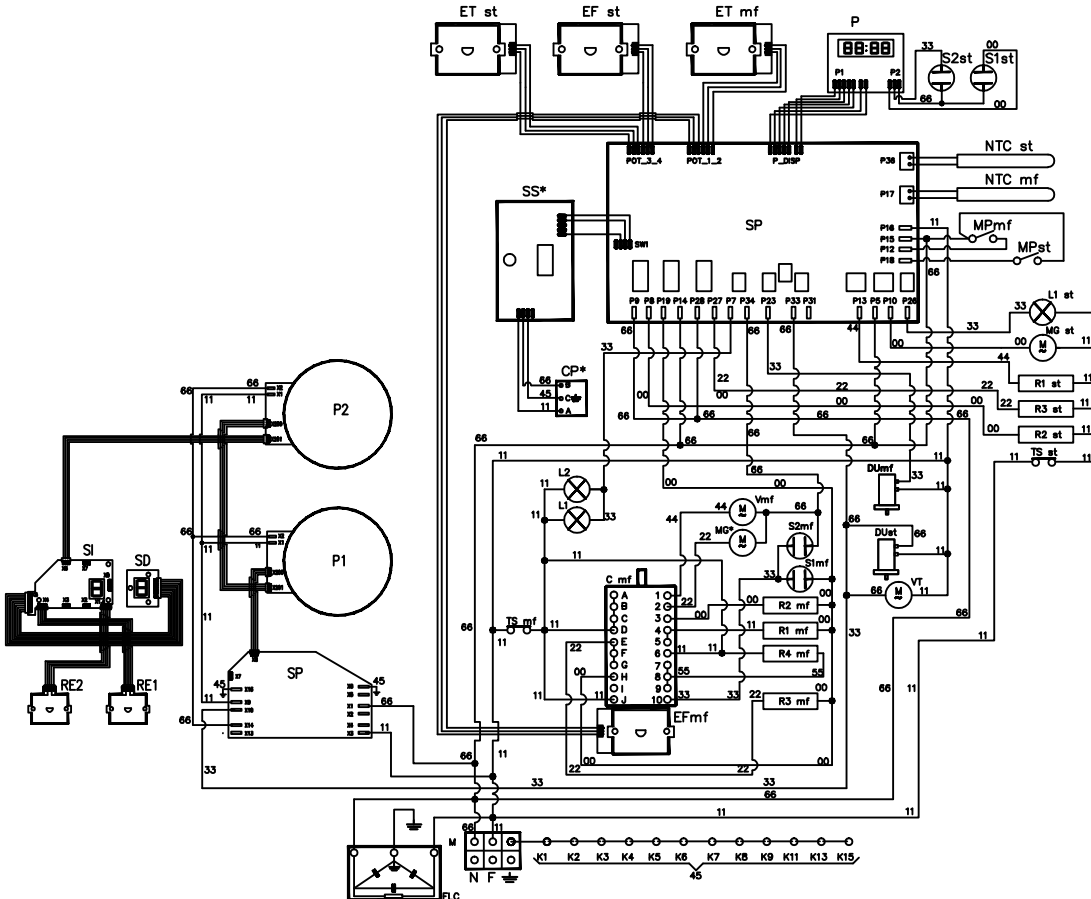

INSTALLATION

Wiring diagrams

P15...E3

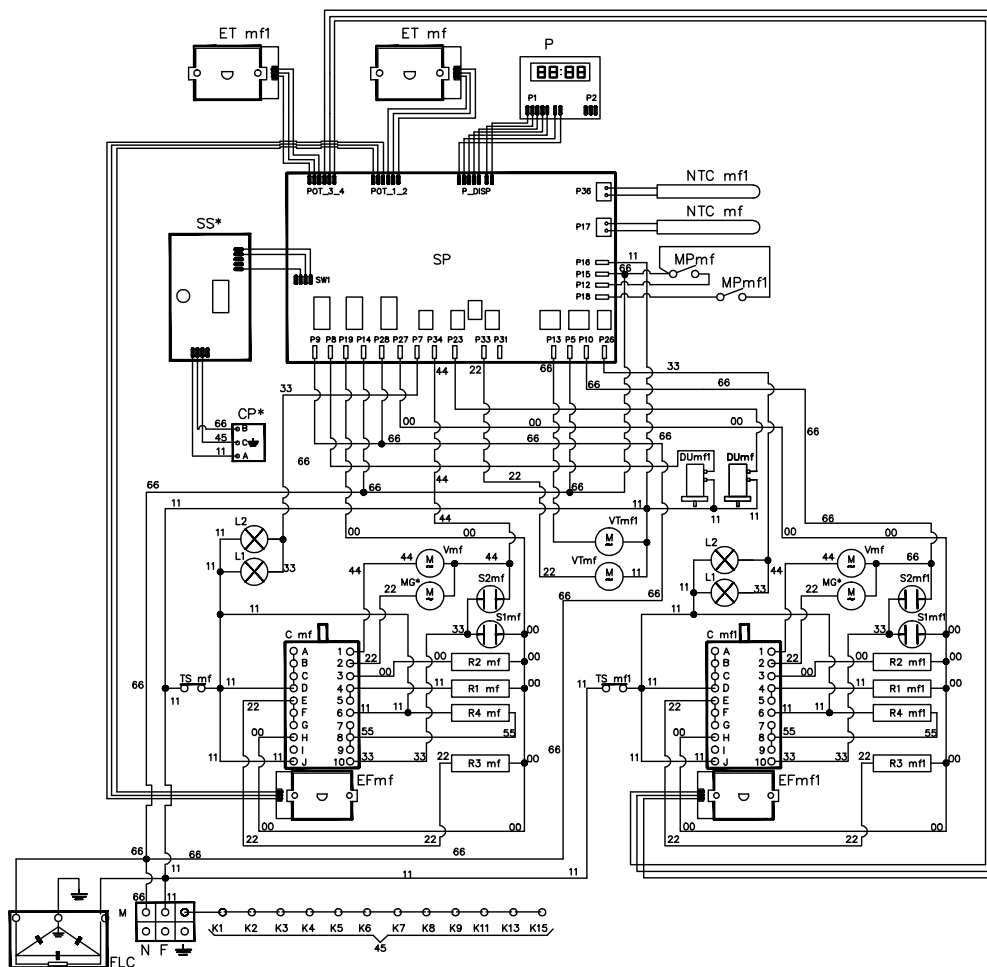

INSTALLATION

Wiring diagrams

PM096S3

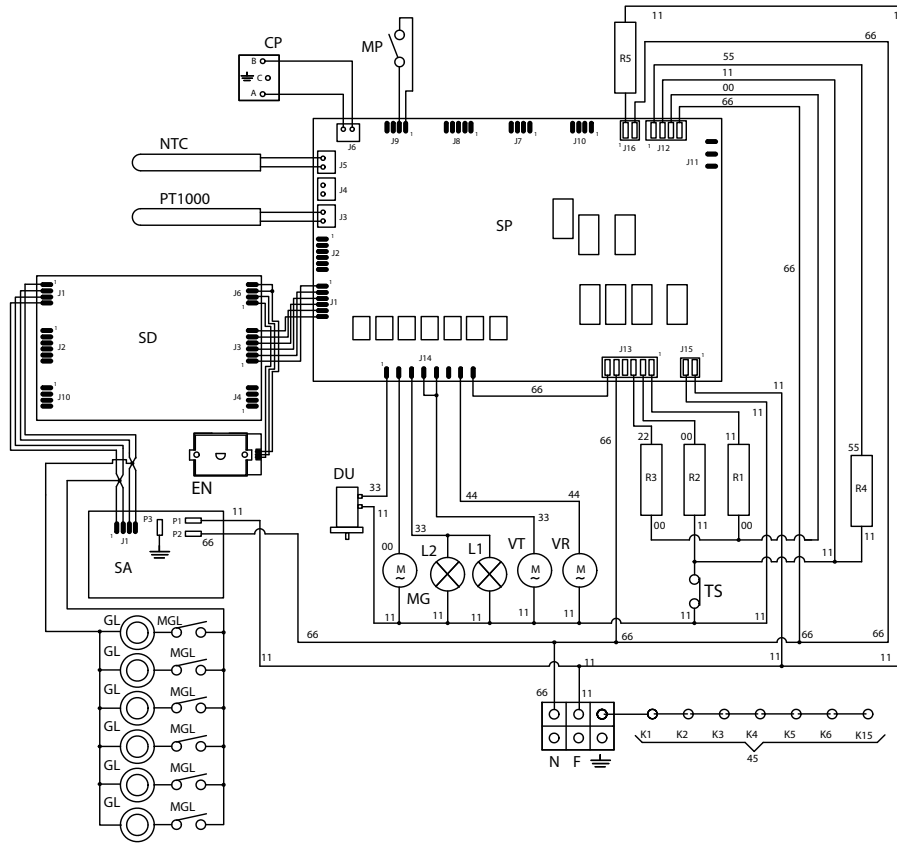

PM12S3

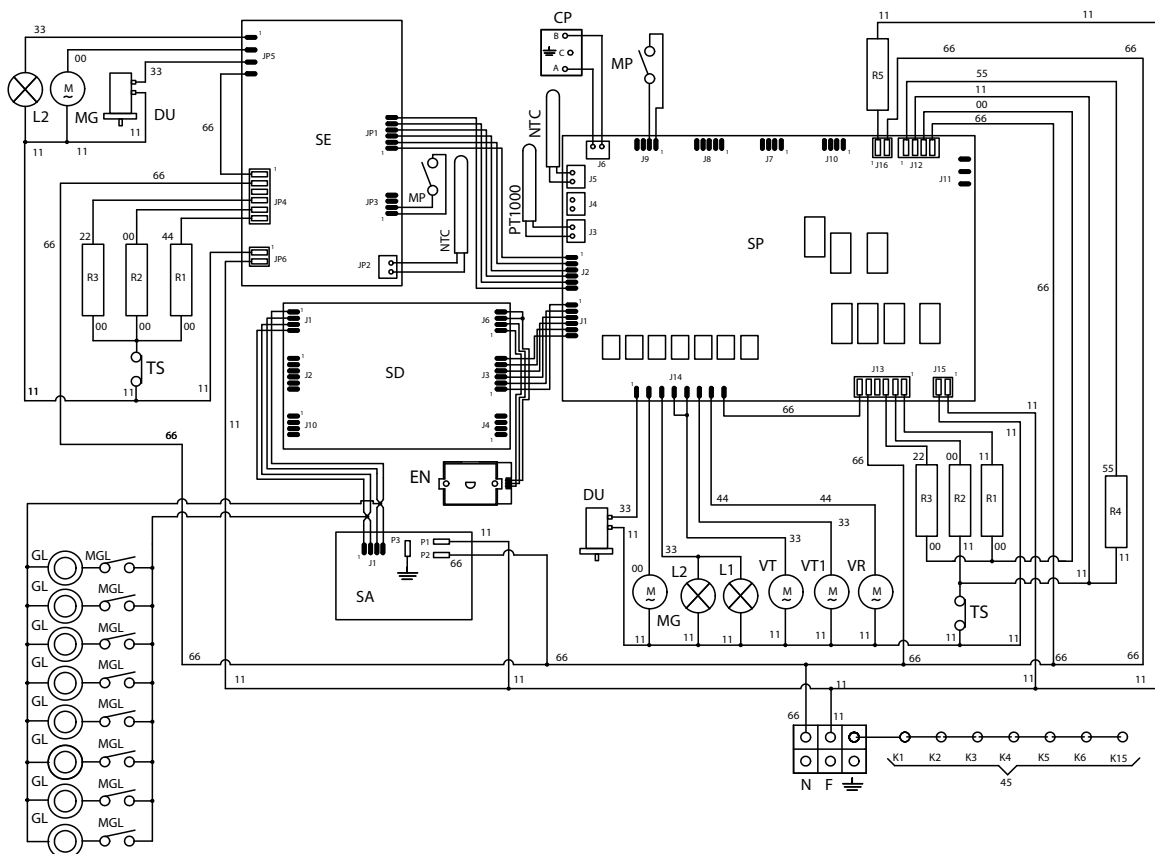

WARRANTY

ILVE AUS & NZ PTY LTD

10/60 York Street
Sydney NSW 2000
tel. 02 92209600
mail@ilve.com

WARRANTY REGISTRATION

Your ongoing satisfaction with your ILVE product is important to us. We ask that you complete the enclosed Warranty Registration Card and return it to us so that we have a record of the ILVE product purchased by you.

PRIVACY

ILVE respects your privacy and is committed to handling your personal information in accordance with the National Privacy Principles and the Privacy Act 1988 (Cth). ILVE will not disclose any personal information set out in the Warranty Registration Card ("Personal Information") without your consent unless required by:

1. law;
2. any ILVE related company;
3. any service provider which provide services to ILVE or assist ILVE in providing services (including repair and warranty services) to customers. Our purpose in collecting the Personal Information is to keep a record of the ILVE product purchased by you, in order to provide a better warranty service to you in the unlikely event that there is a problem with your ILVE product. ILVE may contact you at any one or more of the addresses, email addresses or telephone numbers set out in the Warranty Registration Card.

WARRANTY

1. Warranty

ILVE warrants that each ILVE product will remain, for a period of twenty four (24) months computed from the date of purchase of the ILVE product, free from defects arising in the manufacture of the ILVE product ("Warranty"). Except for consumer guarantees set out in the Competition and Consumer Act 2010 (Cth) ("Act"), ILVE does not make any further warranties or representations in relation to ILVE products.

2. What is not Covered by the Warranty.

The Warranty does not apply if an ILVE product is defective by a factor other than a defect arising in the manufacture of the ILVE product, including but not limited to:

- (a) damage through misuse (including failure to maintain, service or use with proper care), neglect, accident or ordinary wear and tear (including deterioration of parts and accessories and glass breakage);
- (b) use for purpose for which the ILVE product was not sold or designed;
- (c) use or installation which is not in accordance with any specified instructions for use or installation;
- (d) use or operation after a defect has occurred or been discovered;
- (e) damage through freight, transportation or handling in transit (other than when ILVE is responsible);
- (f) damage through exposure to chemicals, dusts, residues, excessive voltage, heat, atmospheric conditions or other forces or environmental factors outside the control of ILVE;
- (g) repair, modification or tampering by the purchaser or any person other than ILVE, an employee of ILVE or an authorised ILVE service contractor;

(h) use of parts, components or accessories which have not been supplied or specifically approved by ILVE.

(i) damage to surface coatings caused by cleaning or maintenance using products not recommended in the ILVE product handbook provided to the purchaser upon purchase of the ILVE product;

(j) damage to the base of an electric oven due to items having been placed on the base of the oven cavity or covering the base, such as aluminium foil (this impedes the transfer of heat from the element to the oven cavity and can result in irreparable damage); or

(k) damages, dents or other cosmetic imperfections not affecting the performance of the ILVE in respect of an ILVE product purchased as a "factory second" or from display. The Warranty does not extend to light globes used in ILVE products.

3. Domestic Use

Each ILVE product is made for domestic use. This Warranty may not extend to ILVE products used for commercial purposes.

4. Time for Claim under the Warranty

You must make any claim under this Warranty within twenty eight (28) days after the occurrence of an event which gives rise to a claim pursuant to the Warranty.

5. Proof of Purchase

Customers must retain proof of purchase in order to be eligible to make a warranty claim in respect of an ILVE product.

6. Claiming under the Warranty

Customers will bear the cost of claiming under this Warranty unless ILVE determines the expenses are reasonable, in which case the customer must claim those expenses by providing written evidence of each expense to ILVE at the address on the Warranty Registration Card.

7. Statutory Rights

(a) These terms and conditions do not affect your statutory rights.

(b) The limitations on the Warranty set out in this document do not exclude or limit the application of the consumer guarantees set out in the Act or any other equivalent or corresponding legislation in the relevant jurisdiction where to do so would:

(i) contravene the law of the relevant jurisdiction;

or

(ii) cause any part of the Warranty to be void.

(c) ILVE excludes indirect or consequential loss of any kind (including, without limitation, loss of use of the ILVE product) and (other than expressly provided for in these terms and conditions) subject to all terms, conditions and warranties implied by custom, the general law, the Act or other statute.

(d) The liability of ILVE to you for a breach of any express or non-excludable implied term, con

(i) replacing or repairing the defective part of the ILVE product;

(ii) paying the cost of replacing or repairing the defective part of the ILVE product;

(iii) replacing the ILVE product; or

(iv) paying the cost of replacing the ILVE product.

(e) Our goods come with guarantees that cannot be excluded under the Australian Consumer Law. You are entitled to a replacement or refund for a major failure and for compensation for any other reasonably foreseeable loss or damage.

You are also entitled to have the goods repaired or replaced if the goods fail to be of acceptable quality and the failure does not amount to a major failure.

8. Defects

Any part of an ILVE product deemed to be defective and replaced by ILVE is the property of ILVE. ILVE reserves the right to inspect and test ILVE products in order to determine the extent of any defect and the validity of a claim under the Warranty.

WARRANTY

Warranty Card tear off

WARRANTY REGISTRATION CARD
01072019

Please complete and send to ILVE at: Via Antoniana, 100 35011
Campodarsego PD, Italy

Last Name:		First Name:	
Address:			
State:	Postcode:	Email:	
Home Phone:		Mobile:	
Purchase Date: / /		(Please attach proof of purchase to validate warranty)	

MODEL NUMBER	SERIAL NUMBER
1	
2	
3	
4	

01012020

ONLY FOR AUTHORIZED CUSTOMER SERVICE

After sales service and any necessary replacement parts contact information:



ILVE AUS & NZ PTY LTD
10/60 York Street
Sydney NSW 2000
tel. 02 92209600
mail@ilve.com

www.ilve.com



Live,
Cook,
Love.

ilve.com

ILVE S.p.A Via Antoniana, 100 – 35011 – Campodarsego (PD) Italy
T. +39 049 9200990 / Email: mail@ilve.com

cod. EI33960710000AU 03/2026