

MACCHINA PER IL CAFFÈ ESPRESSO AUTOMATICA

IT

Installazione - Uso - Manutenzione

AUTOMATIC ESPRESSO COFFEE MAKER

GB

Installation - Use - Maintenance

MACHINE A CAFÉ ESPRESSO AUTOMATIQUE

FR

Installation - Emploi - Entretien

AUTOMATISCHE ESPRESSO-MASCHINE

DE

Installation - Gebrauch - Wartung

CAFETERA EXPRES AUTOMÁTICA

ES

Instalación - Uso - Mantenimiento

MÁQUINA DE CAFÉ EXPRESSO AUTOMÁTICA

PT

Instalação - Uso - Manutenção

Dear Customer,

we would like to thank you and congratulate you on your choice.

This new product has been carefully designed and built using top quality materials, and meticulously tested to ensure that it meets all your culinary requirements.

GB Please read and observe these simple instructions, which will enable you to achieve excellent results from the very first time you use it. This state-of-the-art appliance comes to you with our very best wishes.

THE MANUFACTURER

I Italiano

GB English

FR Français

DE Deutsch

ES Español

PT Português

THIS PRODUCT IS DESIGNED FOR DOMESTIC USE. THE MANUFACTURER DECLINES ALL RESPONSIBILITY FOR DAMAGES TO THINGS OR PEOPLE DERIVING FROM INCORRECT INSTALLATION OR IMPROPER, ERRONEOUS OR UNSUITABLE USE.

THE APPLIANCE MUST NOT BE USED BY PEOPLE (INCLUDING CHILDREN) WITH PHYSICAL, SENSORIAL OR MENTAL IMPAIRMENTS, OR BY PEOPLE WITHOUT THE NECESSARY EXPERIENCE OR KNOWLEDGE, UNLESS THEY ARE SUPERVISED OR INSTRUCTED IN THE USE OF THE APPLIANCE BY A PERSON RESPONSIBLE FOR THEIR SAFETY.

CHILDREN MUST BE SUPERVISED TO ENSURE THAT THEY DO NOT PLAY WITH THE APPLIANCE.

CONTENTS

1. FOR YOUR SAFETY

- During use
- For installation and maintenance

2. RECOMMENDATIONS FOR THE PROTECTION OF THE ENVIRONMENT

- Packing
- Obsolete equipment

3. INSTALLATION

- Installation in modular furniture
- Components for the installation of the machine
- Installation of the machine
- Electrical connection

4. DESCRIPTION OF THE COFFEEMAKER

5. TECHNICAL CHARACTERISTICS

- Fuses

6. DESCRIPTION OF THE CONTROL PANEL TOUCH BUTTONS

7. FIRST USE

- Fill the water tank
- Fill the container with coffee beans
- Turning on the machine in standby mode
- Regulation of the ground coffee
- Wash function

8. DISPENSING COFFEE

9. DISPENSING HOT WATER

10. DISPENSING STEAM

11. PROGRAMMING THE QUANTITY OF GROUND COFFEE

12. PROGRAMMING THE QUANTITY OF HOT WATER

- Restoring the factory settings

13. ILLUMINATION OF THE DISPENSING COMPARTMENT

14. WARNINGS AND ALARMS

- No water warning
- Replace filter warning
- Coffee grounds warning
- Coffee probe broken warning
- Generic alarm warning

15. RECIPES

- Italian Cappuccino
- Viennese Cappuccino
- Cold Espresso Chilled in a Shaker
- Irish coffee
- Mexican Coffee
- Cappuccino Ice Cream

16. CLEANING AND MAINTENANCE

- External parts
- Steam nozzle
- Drip basin
- Emptying used coffee grounds
- Water tank

17. TROUBLESHOOTING

18. SERVICE, REPLACEMENT PARTS AND WARRANTY

SYMBOLS

Durante la lettura del manuale vi capiterà di incontrare i seguenti simboli:



ATTENTION: important instructions for the safe and correct use of the machine



information useful for the optimal use of the equipment.

GB

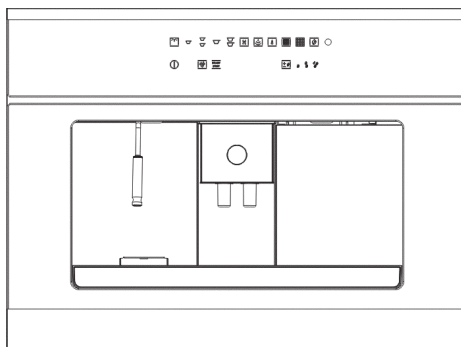

1. FOR YOUR SAFETY

Although the machine is simple to use, it is important that you read the entire booklet before installing or using the machine for the first time. By doing so, you will achieve the best performance, avoid mistakes, use the machine in absolute safety and protect the environment.

During use

- This machine must only be used by adults. Other-abled persons can use the machine only if there is a person responsible for their safety that will supervise and instruct them in the use of the machine.
- *Make sure that children do not touch the controls or play with the machine.*
- *This machine is intended for home use; another other use is considered improper and, therefore, dangerous.*
- Always keep the machine clean.
- *It is dangerous to modify, or attempt to modify, the characteristics of this product.*
- The exposed parts of this machine get hot during operation and remain hot for a certain period of time after it is turned off. Keep children away until the machine has cooled.
- Do not touch the hot surfaces during use but use the knobs or handles.
- *Make sure the machine is disconnected from the electric mains before any maintenance or cleaning.*
- If the machine breaks, do not try and repair it yourself. Repairs made by unqualified persons can cause damage and accidents. Consult the contents of this booklet. If you don't find the information you need, contact the nearest service centre. This machine must be serviced by an authorised Service Centre. Always request the use of original replacement parts.

For installation and maintenance

- After unpacking the machine, check that the product has not been damaged and that the power cord is in perfect condition. If not, contact the reseller before operating the machine.
- The packing materials (plastic bags, styrofoam, etc.) must not be left within the reach of children because they are potentially dangerous.
- Before use, check that the voltage and power listed on the machine's nameplate match the line to which it will be connected. Also make sure that the building has an efficient earth line and a suitable circuit breaker.
- *Any service must be performed by specialised personnel.*
- *The manufacturer will not be liable if these rules are not followed.*

2. RECOMMENDATIONS FOR THE PROTECTION OF THE ENVIRONMENT

Packing

All packing materials used are safe for the environment and recyclable. Please make your contribution to protecting the environment by disposing of the packing in the appropriate recycling bins.

Obsolete equipment

- Machines that are obsolete or no longer used should not be thrown away in the trash. Through ecological disposal, the various materials used in the production of your machine can be recovered.
- Ask your specialised reseller or your city administration about disposal options.
- Before scrapping the machine, cut the power cord to make it unusable.

It is very important to keep this instruction booklet for future consultation. If the machine is sold or given to another person, make sure to give the booklet to the new user so that they will be informed about the operation of the machine and the relative warnings.



This symbol  on the product or packaging means that the product must not be thrown away in household waste but must be taken to a collection point for recycling electrical and electronic equipment. By disposing of this product properly, you will avoid potential damage to the environment and health caused by the incorrect disposal of the product. For more detailed information about recycling this product, contact your city administration, local waste disposal service or the store where you purchased it.

3. INSTALLATION OF THE MACHINE

“BUILT-IN” INSTALLATION IN MODULAR FURNITURE

For the good operation of the machine when built-in to modular furniture, the latter must have suitable characteristics.

In conformity with safety standards, protection against contact with electrical parts and parts protected with just functional insulation must be provided through the correct housing of the machine.

All the parts that provide protection, including any covering panel (for example, if the machine is positioned at the end or beginning of the modules), must be fastened in such a way that they cannot be removed with the aid of a tool.

It is also a good idea to install the machine at a certain distance from refrigerators or freezers because the heat it emits could affect their operation.

Components for the installation of the machine

The machine must be installed in compartments that are 460 mm high and between 560 and 568 mm wide. The following installation components are supplied with the machine.

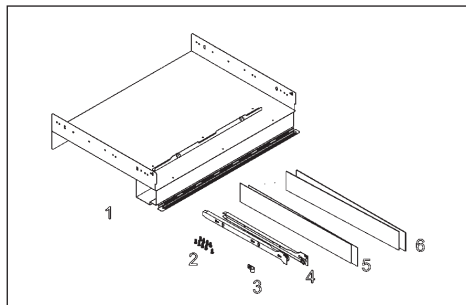

1. Fixed support of the machine.
2. N°13 self-threading screws 3.9X19
3. N°1 fixed power cord
4. N°2 lateral guides
5. N°2 lateral 1-mm plates
6. N°2 lateral 2-mm plates

Installation of the machine

Position the fixed part provided by resting it on the surface of the furniture

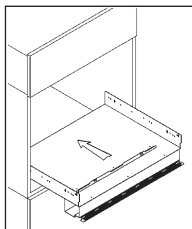

Insert the side plates needed to compensate for any empty spaces. The width of the compartment that houses the machine is determined by the thickness of the sides of the furniture. Four plates are supplied to compensate for the different measures obtainable, two that are 2 mm thick and two that are 1 mm thick. They are used to compensate for the internal width of the compartment to obtain an measurement of 562-560 mm.

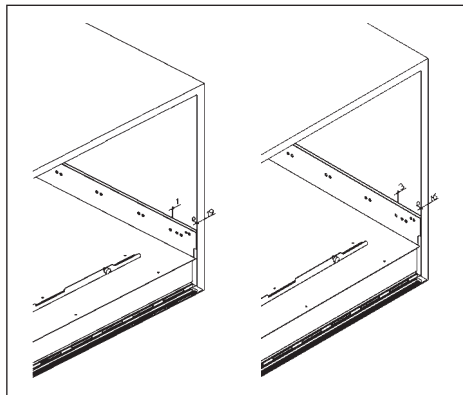

Then mount the 2 guides using the remaining 8 self-threading screws.

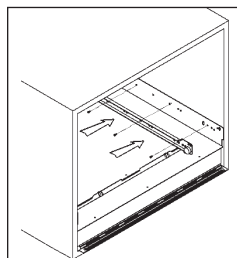

Insert the machine by matching up the guides with the supports already mounted in the compartment.

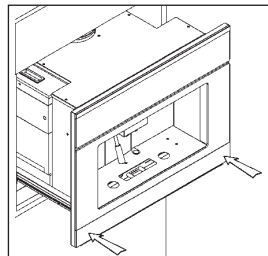

Slide it all the way in until the safety stops click.

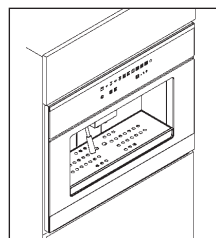

Electrical connection

Fasten the power to the left side of the compartment using one of the self-threading wood screws provided and the fixed cord as indicated in the figure.

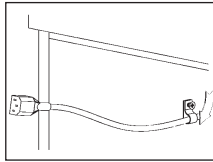

Loosen the fixed cord mounted on the machine.

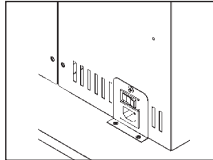

Tighten the power cord on the machine, as shown in the figure.

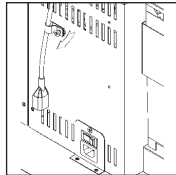

Connect the power cord as shown in the figure.

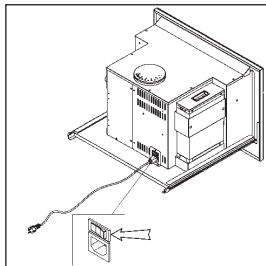

4. DESCRIPTION OF THE COFFEEMAKER

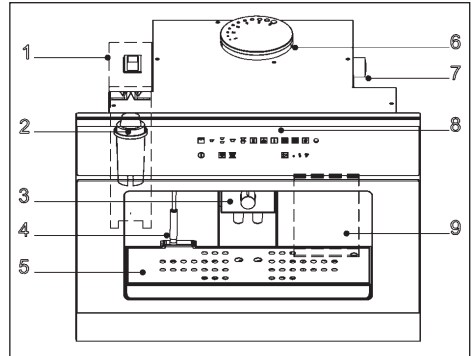

1. Water tank
2. Decalcifying filter
3. Dispenser
4. Water/steam dispensing nozzle
5. Drip basin
6. Coffee container
7. Grind regulation knob
8. Control panel
9. Door/tray for emptying the coffee grounds

5. TECHNICAL CHARACTERISTICS

Width	594 mm
Depth	475 mm
Height	445 mm
Tank capacity	2.5 l
Net weight	26 kg
Gross weight	31 kg
Power supply voltage	230 V
Rated power	2000 W
Power absorbed by the heating elements	1700 W
Power absorbed by the pump	50 W
Operating pressure	12 bar

6. DESCRIPTION OF THE CONTROL PANEL: TOUCH BUTTONS



Control panel

Description of the buttons and indicator lights on the control panel.

	ON/OFF button
	START/STOP button
	COFFEE button
	STRETCHED COFFEE button
	WATER button
	NO WATER alarm
	GROUNDS PRESENT alarm
	GENERIC ALARM
	WASH button

	LIGHT button
	DOUBLE COFFEE button
	DOUBLE STRETCHED COFFEE button
	STEAM button
	REPLACE FILTER alarm
	COFFEE probe broken alarm
	COFFEE regulation
	LIGHT COFFEE
	MEDIUM COFFEE
	STRONG COFFEE

i The exclusive feature of this model is the use of touch-control technology. Just touch the area of the symbol and the machine will perform the corresponding function. However, you will notice that you must exert slight pressure to activate the controls, just like a normal button; this is to avoid accidental commands.

7. FIRST USE

Fill the water tank

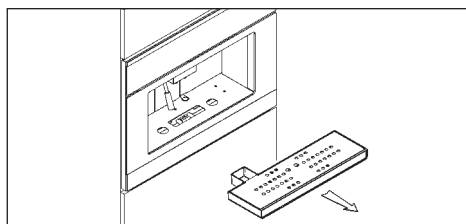

Fig. 7.1 Remove the drip basin from its seat

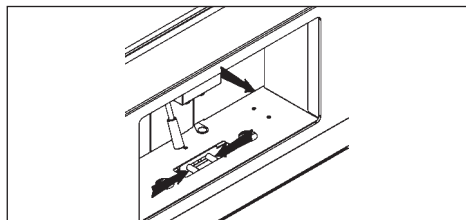

Fig. 7.2 Press the unlocking lever under the drip basin and pull the machine towards you as shown in the figure.

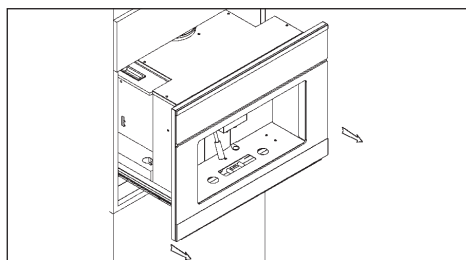

Fig. 7.3 Pull the coffeemaker out of the furniture by sliding it on its guides.

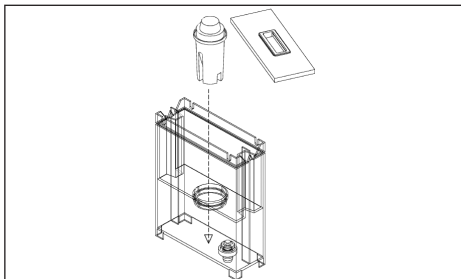

Fig.7.4 Insert the decalcifying filter in its seat. Before filling the water tank, make sure that the decalcifying filter was soaked in cold water for at least 20 minutes (in any case, follow the instructions on the filter package). After soaking, insert it in its seat inside the tank, as shown in the figure, until you hear a click. If the machine has not been used in a long time, we recommend changing the water in the tank. The filter can be purchased at an appliance store, our Service Centres or at authorised replacement parts stores.

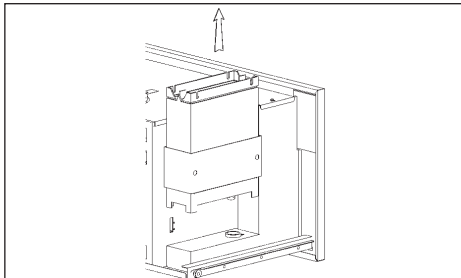

Fig. 7.5 Remove the water tank as shown in the figure and fill it with drinking water (about 2.5 litres).

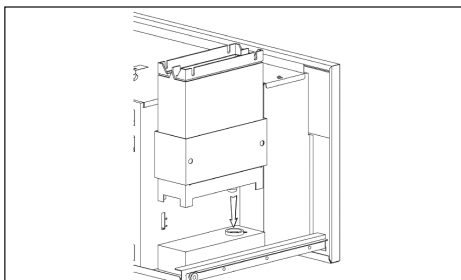

Fig. 7.6 Put the tank back in its seat, taking care to match up the two connections on the bottom.

Fill the container with coffee beans

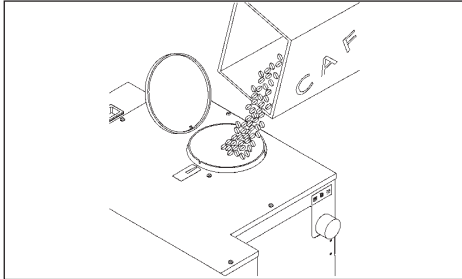

Fig. 7.7 Pour about 200 g of coffee beans in the coffee container.

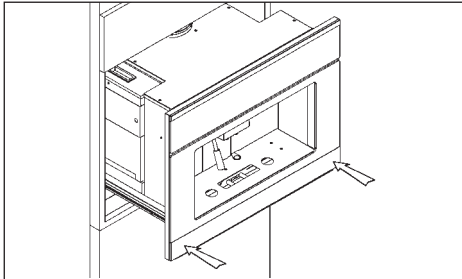

Fig. 7.8 Push the machine back into the compartment until you hear a "CLICK!", which means it's locked into place.



ATTENTION: before pouring beans into the grinder, make sure that there are no foreign bodies in the coffee.

Turning on the machine in standby mode

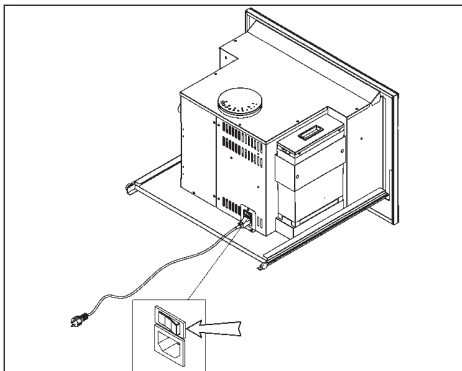

Fig. 7.9 Pull out the machine.

Turn the main switch, located on the back of the machine, to position "1".

After you push the machine back into the furniture, it is ready to use.

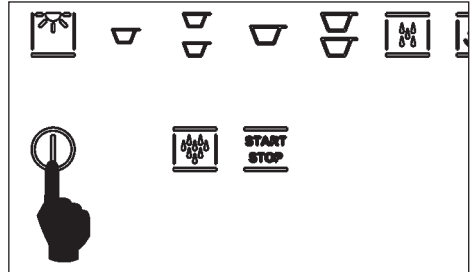

Fig. 7.10

To exit standby mode, you must press the on/off button, as shown in Fig. 8.10. The LED will begin to flash until the machine is "ready". At this point, all the LEDs for the various services will be lit.

NOTE: If the machine is not used for 45 minutes, it returns to standby mode.

REGULATION OF THE GROUND COFFEE



ATTENTION: The fineness of the coffee grind is calibrated at the factory.

This fineness has a strong influence on producing good coffee. Too "coarse" a grind produces coffee that flows quickly without creaminess and body. On the other hand, too fine a grind produces coffee that "drips" with a very intense taste and a "burned" smell. Keep in mind that producing a cup of espresso coffee takes from 20 to 30 seconds.

To regulate the grind, you must pull out the machine as shown in figures 8.1 to 8.3. Turn the regulation knob on the right side, as shown in Fig. 8.11.



IMPORTANT: The coffee beans outside the vacuum pack have a limited life and should not remain in the machine for long. Coffee beans can in fact block the coffee grinder. Once the packs have been opened, the coffee beans ought to be stored in sealed containers away from sunlight. For best results, always use fresh coffee beans.

9. DISPENSING HOT WATER

To dispense hot water, suitably position the water/steam nozzles, see Fig. 10.1

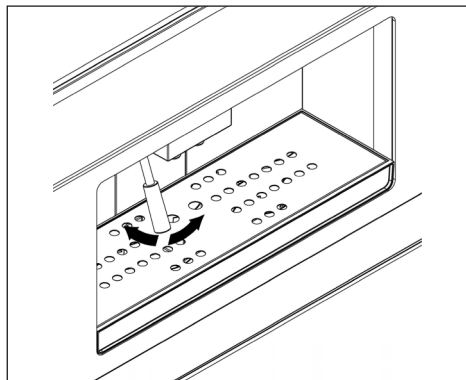

- Position a container below the water/steam nozzle.
- Press the hot water button.
- Press the START button with 10 seconds from making your selection. The water will be dispensed as long as the button is pressed; to stop dispensing, release the button.



ATTENTION: if the start button is not pressed within 10 seconds, the function is disabled. If you wish to dispense a beverage, you will have to repeat the procedure.



We recommend that you do not dispense hot water immediately after dispensing steam.

10. DISPENSING STEAM

To dispense steam, press the steam button. The corresponding indicator light will flash for 15 seconds. As soon as the indicator light stops flashing and remains steady on, the machine is ready to dispense steam.

- Place the container with the liquid to be heated below

the steam nozzle.

- Completely immerse the nozzle in the liquid to be heated.
- Press the START button within 10 seconds from making your selection and wait for the steam to come out.

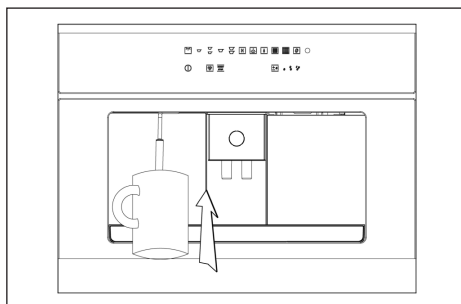

ATTENTION: if the start button is not pressed within 10 seconds, the function is disabled. If you wish to dispense a beverage, you will have to repeat the procedure.

The steam will continue to flow until you release the START button.



If you are preparing milk for a cappuccino, we suggest that you agitate the milk container for better results.

11. PROGRAMMING THE QUANTITY OF GROUND COFFEE

You can choose from three strengths of coffee:

- light;
- medium;
- strong.

To change from one type of coffee to the other, just press the button as shown in Fig. 12.1. The LED for the selected coffee will light (in Fig. 12.2, light coffee).

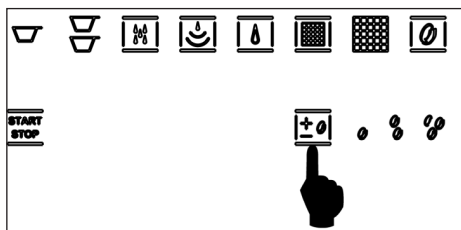

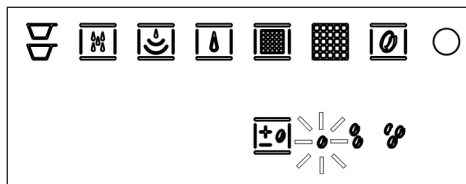

FOR EXPERT USERS ONLY: PROGRAMMING THE GRINDING TIME

The grinding time for strong coffee is programmable and medium and light coffee are calibrated accordingly. To enter programming mode, when the machine is in standby mode:

- press the START/STOP button for 5 seconds; the LED s on the upper left line light up to indicate the grinding time;
- to increase the time, press the coffee regulation button and to, decrease it, the START/STOP button. At the end of the operation, just press the on/off button to exit and confirm the changes.

Automatic adjustment of coffee quantity.

If the quantity of coffee has been wrongly adjusted, so as not to allow coffee dispensing, the machine is able to perform a series of automatic checks, until the right quantity of coffee and therefore correct dispensing is achieved.

Automatically and without any intervention by the machine operator, the machine will start grinding the coffee (indicated by a number of flashes of the "generic alarm" symbol) and will try and dispense coffee.

The procedure terminates when the coffee is dispensed and consequently the new coffee quantity parameters are stored.

A request could be made to perform a washing operation. If so, perform washing as described in chapter 7. Afterwards, make a cup of coffee. If the machine starts grinding coffee again automatically and without the intervention of the operator, switch it off and call in the after-sales service.

12. PROGRAMMING THE QUANTITY OF COFFEE IN THE CUP

All the cycles have a preset quantity, except for water and steam.

The machine is already calibrated at the factory to dispense the ideal quantity of coffee for an espresso cup.

While dispensing the beverage, you can stop dispensing before the preset time by pressing the START/STOP

button.

The procedure for programming the quantity of coffee, and other beverages, in the cup is as follows:

- press the coffee key for 5 seconds until the LED flashes.

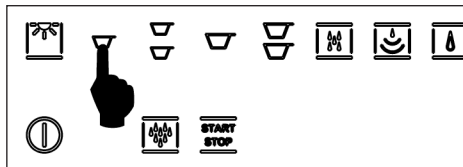

- press the START/STOP key to start dispensing. The two LEDs flash for its duration.

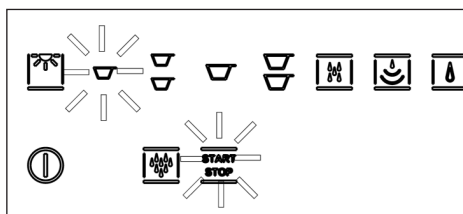
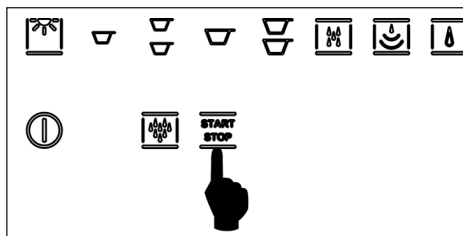

- press the START/STOP button again when the desired quantity is reached.

Restoring the factory settings

When it leaves the factory, the machine is calibrated for Italian-style espresso coffee and German-style stretched coffee.

- If you need to restore these standard values, you must place the machine in standby and press the coffee regulation button for 6 seconds.
- You will see all the LEDs, except on/off, flash for 5 seconds; after that time, the board has stored the default values.
- Press the on button and the selections will now use the factory values.



The standard values are only relative to the quantity of water necessary for each single dose.

13. ILLUMINATION OF THE DISPENSING COMPARTMENT

The machine has LEDs for illuminating the dispensing compartment. To activate this function, just press the light button as shown in Fig. 13.1.

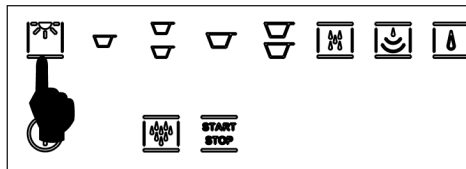

The light function is only available when the machine is on and not during standby mode.

RISK GROUP 2

CAUTION: do not stare at the lamp while it is on. It could damage your eyesight

14. SIGNALLING AND ALARMS

No water warnin

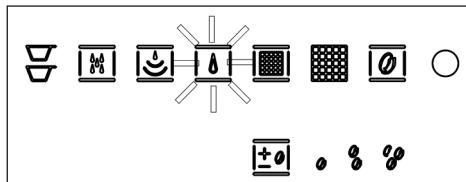

The machine has a sensor that checks for water in the tank. If there is no water, the machine turns on the indicator light and will not work until the tank is filled.

Replace filter warning

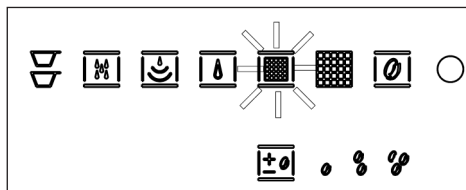

After the machine has dispensed 80 litres of water, the LED for the filter symbol begins to flash (pre-alarm), Fig. 14.2.

If the quantity of dispensed water reaches 100 litres, the LED will turn steady-on (alarm).



The replacement of the filter is recommended within 3 months from when the LED remains steady-on.

To switch-off the alarm (or the pre-alarm), put the appliance in stand-by condition, hold the START/STOP button for 5 seconds; the alarm led will switch-off and the counter of dispensed water will reset.

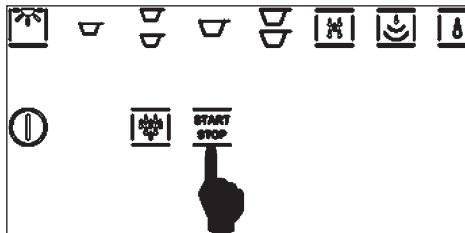

Mandatory washing and presence of coffee grounds

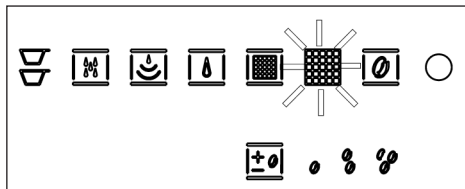

After dispensing 10 cups of coffee, the wash light turns on steady red, while the grounds drawer LED flashes with a red light. This condition persists even when the machine is turned off and on. To reuse the machine, you must wash the coffee following these points:

- press START;
- wait for the wash icon to go off;
- open the door and empty the grounds;
- wait for the grounds icon to go off;
- fit the grounds holder back in;
- close the door.

Now the machine is ready to make 10 more cups of coffee

For emptying the tray of "used" coffee grounds see Chapter 16 "CLEANING".

Coffee probe broken warning

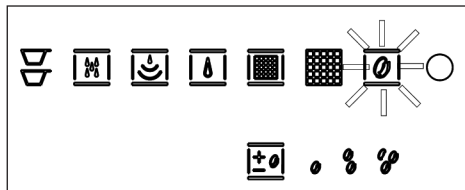

The machine has a function that warns you when the coffee unit probe is broken.

When the coffee probe is not working correctly, the relative LED flashes.

Try to turn the machine off and on.



ATTENTION: if the alarm persists, contact the service centre.

Generic alarm warning

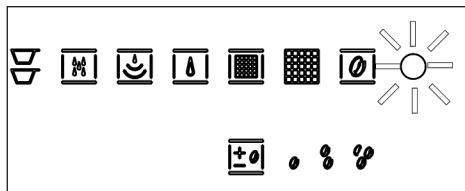

The generic alarm indicator lights up (Fig. 15.5) for a variety of possible reasons:

- The automatic coffee dispensing unit is blocked;
- The movement of the automatic coffee dispensing unit did not occur correctly;
- The door for removing the coffee grounds is open;
- The volumetric counter did not detect the passage of water;
- The temperature probe is not working correctly.

If the generic alarm light turns on:

- Check that the grounds emptying door is closed.
- Check that there is water in the tank.

Turn the machine off and on. If the problem persists, contact service.

15. RECIPES

Italian cappuccino

This is a normal espresso with the addition of milk heated by steam, which softens the taste of the coffee and creates a consistent and pleasant surface foam. It is served in a large cup. Place the cold milk in a tall pitcher and use the steam jet, if available. Add just the foam to the espresso coffee by tilting and shaking the pitcher or use a spoon. You can dust the top of the foam with cocoa.

Viennese cappuccino

This variant is the product of the age-old Austrian tradition. Prepare a stretched espresso (extracted for 30-35 seconds), add warm milk and put whipped cream on top. It is served in a cup of intermediate size between an espresso cup and a cappuccino cup. Garnish with chocolate flakes.

Cold espresso chilled in a shaker

Frothy and very refreshing, it's a real pleasure on hot days. Prepare an espresso, add sugar, immediately pour it in a shaker with large cubes of ice and shake for several seconds. It is served in a tumbler or flute glass.

Irish coffee

An energising pick-me-up. In a tall, heated glass, mix eight parts hot coffee, one part of whiskey and cane sugar.

Add freshly whipped cream by sliding it on the lower part of a spoon: this creates a light layer of cool cream on top of the hot coffee.

Mexican coffee

Intense and exotic.

In a small cup, mix one dose of double cream, a teaspoon of cinnamon, a pinch of nutmeg, sugar and whip.

Pour a teaspoon of chocolate syrup in a medium cup, add a little more cinnamon and the coffee and mix well. Garnish with a teaspoon of vanilla-flavoured cream.

Cappuccino ice cream

In a pan, heat two cups of espresso, $\frac{3}{4}$ cup of whipping cream and $\frac{1}{2}$ cup of sugar; bring to a boil.

When the compound is lukewarm, place it in the refrigerator for 4-5 hours.

Put two or three scoops in a bowl and garnish to toasted coffee beans.

Let cool in the refrigerator for $\frac{1}{2}$ hour before serving.

16. CLEANING



ATTENTION: do not immerse the machine in water for cleaning.

External parts

The external parts of the machine must be cleaned with a soft cloth and without the use of aggressive detergents. Do not clean steel parts of scouring pads or abrasive sponges. Dry well with a soft cloth

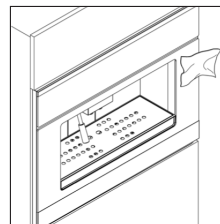

Steam nozzle

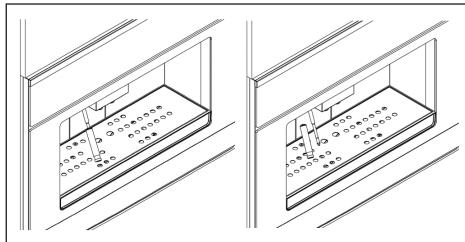

In addition, periodically clean the steam nozzle, which can get dirty inside when you warm milk for cappuccino. To do this, just disassemble it as shown in the figure and wash it together with its hood with a sponge and hot water.



ATTENTION: when cleaning the nozzle, always turn off the machine and remember to wait at least 20 minutes before using it to allow it to cool, avoiding possible burns.

Drip basin

Remove the drip basin from the machine as shown in the following figures.

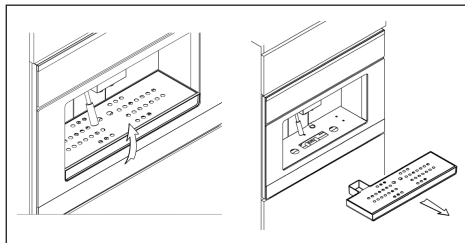

Make sure to periodically empty the basin to avoid liquid spills that could dirty and ruin the furniture below. The basin and relative metal grill can be washed in the dishwasher.

Emptying used coffee grounds

To open the door of the compartment with the tray, you must first remove the drip basin as described in Figures 16.4 and 16.5.

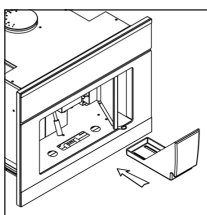
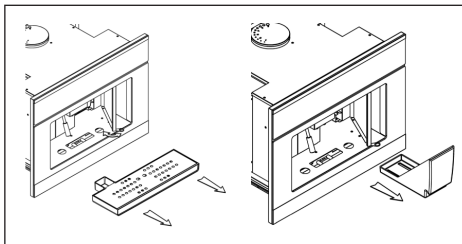

Remove the tray, empty the coffee grounds and wash it with hot water or in the dishwasher.

Put the “used” coffee ground tray back in its compartment.

Water tank

- If the machine has not been used in a long time, we recommend changing the water in the tank
- Periodically clean the water tank of any lime encrustations.
- The tank can be washed in the dishwasher.
- If using the Brita decalcifying filter, we recommend replacing the filter every 2000 espresso coffees or at least every six months.

17. TROUBLESHOOTING

The operator should make sure that the problem is not caused by:

- No electricity
- No water in the tank
- No coffee in the machine
- Incorrect closure of the access door to the coffee ground tray.

For any other causes, have the machine checked by a service centre.

